

ET-2200 Series Ethernet I/O Modules User Manual

Ethernet I/O Module Ver. 1.8, Oct. 2024



WARRANTY

All products manufactured by ICP DAS are warranted against defective materials for a period of one year from the date of delivery to the original purchaser.

WARNING

ICP DAS assumes no liability for damages consequent to the use of this product. ICP DAS reserves the right to change this manual at any time without notice. The information furnished by ICP DAS is believed to be accurate and reliable. However, no responsibility is assumed by ICP DAS for its use, nor for any infringements of patents or other rights of third parties resulting from its use.

COPYRIGHT

Copyright © 2023 by ICP DAS. All rights are reserved.

TRADEMARK

Names are used for identification only and may be registered trademarks of their respective companies.

CONTACT US

If you have any questions, please feel free to contact us via email at: service@icpdas.com



REVISION HISTORY

The table below shows the revision history.

Revision	Date	Description
1.8	Oct. 2024	Add the feature - "TCP Streaming" in Section 1.2
	Aug. 2024	Add Section 6.4.5, 6.4.6 Modbus Register for (P)ET-2224CIS/2228CIS/2224CI/2228CI
	Jul. 2024	Add product models: (P)ET-2224P/2228P
	May. 2024	Add product models: (P)ET-2215H, (P)ET-2215H-16, (P)ET-2218H/S1, (P)ET-2218H-16/S1, (P)ET-2224CI/2228CI, (P)ET-2224CIS/2228CIS, (P)ET-2242U-32. <ol style="list-style-type: none"> Revise Section 2.1 Appearance, 2.2 Specification, 2.5 Dimensions Add Section 4.4.3 AI Configuration— (B) RTD Input, (C) Thermocouple Input Add Section 4.4.4 AI Calibration— (B) RTD Input, (C) Thermocouple Input Add Section 4.16.5 –AI Example Add Modbus Register Table Section 6.4.1 for (P)ET-2215H, (P)ET-2215H-16 Section 6.4.4 for (P)ET-2218H/S1, (P)ET-2218H-16/S1 Add Type Code Table Section 6.6 RTD Section 6.7 Thermocouple
1.7	Mar. 2024	✧ Section 6.4.1, (P)ET-2217 Modbus Register - (Addr. 00833)
	Sep. 2023	<ol style="list-style-type: none"> Revise Section 3.2, 3.3 Add Section 4.4.4 AI - Calibration Add Section 4.4.8 AO - Calibration Add Section 4.16.2 ~ 4.16.4, MQTTX and DI/DO Examples Revise Chapter 5 I/O Pair Connection Applications Add Section 5.5.3 Example of Using Memory AIO Revise Appendix A.1 How Can I Factory Reset the Module?

Revision	Date	Description
1.6.0	Mar. 2023	<ol style="list-style-type: none"> 1. Revise Section 6.4.1. The sampling rate of PET-2217 in fast mode is 200 Hz, and in normal mode is 20 Hz. 2. Revise Section 2.2. Modify the URL of the data sheet 3. Revise Section 6.4.2. The address 31000-31109 and 41000-41109 has been modified to 34097-34206 and 44097-44206
	Jan. 2023	✧ Revise the hardware information in Chapter 2
	Dec. 2022	<ol style="list-style-type: none"> 1. Revise Sections 4.7, 5.1 to 5.4 2. Add Section 5.5 Shared Memory
	Nov. 2022	✧ Add Section 4.17 SNMP
	Sep. 2022	✧ Add the model ET-2217 (The AI module)
	Jun. 2022	✧ Add the model ET-2224/ ET-2228 (The AO module)
	Apr. 2022	✧ Revise Sections 2.2, 2.3, 2.4, and 2.6, add new models
	Jan. 2022	<ol style="list-style-type: none"> 1. Add Modbus addresses in Section 6.4 2. Add Section 6.5 Analog Input Type and Data Format Table
	Nov. 2021	✧ Support MQTT protocol
	Oct. 2021	✧ Add Section 1.3 Application
	Sep. 2021	<ol style="list-style-type: none"> 1. Add the information about ET-2217CI/ 2217CI-4 2. Add Chapter 6.4 Modbus Register (AIO) 3. Add Appendix A.2 ~ A.4
1.5.0	Jun. 2020	✧ Modify the official website-related links.
1.4.0	Sep. 2019	✧ Add the information on the MQTT function.
1.3.0	Jun. 2018	✧ Add the hardware information about the ET-2261-16.
1.2.0	Jul. 2017	<ol style="list-style-type: none"> 1. Add the software and hardware information about the ET-2242U and ET-2255U. 2. Updated the information about the Firmware Version v1.4.6 [Jun.16, 2017] in Chapter 4 Web Configuration. 3. Add Appendix A: Troubleshooting and Revision History.
1.1.3	Feb. 2016	<ol style="list-style-type: none"> 1. Add the software and hardware information about the ET-2254P, ET-2261 and ET-2268. 2. Revise the information about the Firmware Version v1.3.9 [Jan.20, 2016] in Chapter 4 Web Configuration.
1.1.0	Nov. 2015	✧ Add the software and hardware information about the ET-2242, ET-2251 and ET-2255.
1.0.0	Sep. 2015	✧ Initial issue

TABLE OF CONTENTS

1. INTRODUCTION	8
1.1 Packing List.....	8
1.2 Features.....	9
1.3 Application	15
2. HARDWARE INFORMATION	16
2.1 Appearance	16
2.2 Specification.....	20
2.3 Wiring Connections.....	22
2.4 Wiring to the Connector	23
2.5 Dimensions.....	24
3. GETTING STARTED	30
3.1 Configuring the Operating Mode	30
3.2 Connecting to the Network and the PC	31
3.3 Configuring the Network Settings.....	32
3.4 Modbus TCP Testing	34
4. WEB CONFIGURATION	36
4.1 Logging into the Web Server.....	36
4.2 Home.....	39
4.2.1 Home – DI/DO	39
4.2.2 Home – AI	40
4.2.3 Home – AO	41
4.2.4 OVP (Over-value Protection) Mechanism	42
4.3 Network.....	44
4.3.1 IP Address Configuration	44
4.3.2 General Settings	48
4.3.3 Restore Factory Defaults/Firmware Update.....	49
4.4 I/O Settings.....	52
4.4.1 DO Control	52
4.4.2 DI/DO Configuration.....	53
4.4.3 Analog Input Configuration	56
(A) Voltage/Current Input	56
(B) RTD Input.....	57
(C) Thermocouple Input.....	58

4.4.4	AI - Calibration	59
	(A) Voltage/Current Input	59
	(B) RTD Input	61
	(C) Thermocouple Input	64
4.4.5	AI - RTC	66
4.4.6	AI - Data Logger	66
4.4.7	Analog Output Configuration	68
4.4.8	AO - Calibration	69
4.5	Sync	72
4.5.1	DIO Synchronization	72
4.6	PWM.....	74
4.6.1	PWM Configuration	74
4.7	Pair Connection	75
4.7.1	I/O Pair-Connection Settings	75
4.8	Filter	78
4.8.1	Filter Settings.....	78
4.9	Monitor	79
4.10	Change Password	80
4.11	Logout	81
4.12	MQTT.....	82
4.12.1	Connectivity Settings.....	83
4.12.2	Publication Settings	85
4.12.3	Restore Factory Defaults	86
4.13	MQTT-DO.....	87
4.13.1	MQTT – Digital Outputs.....	88
4.13.2	Readbacks of the Digital Outputs.....	89
4.14	MQTT-DI	90
4.14.1	MQTT – Digital Inputs.....	91
4.15	MQTT-AI	92
4.16	MQTT Realization	93
4.16.1	Set up Mosquitto	93
4.16.2	MQTTX Instructions.....	99
4.16.3	MQTT - DO Example	101
	(A) MQTT DO – Subscribe	101
	(B) MQTT DO – Power on Publish	103
	(C) MQTT DO – State Change Publish	106
	(D) MQTT DO – Periodic Publish	108

4.16.4	MQTT - DI Example	110
(A)	MQTT DI – State Change Publish.....	110
(B)	MQTT DI – Periodic Publish	113
4.16.5	MQTT - AI Example	116
(A)	MQTT AI – Periodic Publish	117
4.17	SNMP.....	120
4.17.1	SNMP Agent Configuration.....	121
4.17.2	SNMP Specific Trap	122
4.17.3	SNMP I/O Example	124
4.17.4	SNMP Trap Example	129
4.17.5	SNMP Problem Solving.....	131
5.	I/O PAIR CONNECTION APPLICATIONS	133
5.1	Set a Single Module to Pull/Push Mode (DI/DO)	133
5.1.1	Pull Mode	135
5.1.2	Push Mode.....	136
5.2	Set Two Modules to Push Mode (Local DI to Remote DO)	137
5.3	Set Two Modules to Pull Mode (Remote DI to 2-Local DO).....	140
5.4	Set Two Modules to Push Mode (2-Local DI to Remote DO)	143
5.5	Shared Memory	146
5.5.1	Address Mapping for Shared Memory	147
5.5.2	Application of spreading the load (DIO).....	148
5.5.3	Example of Using Memory AIO	150
5.5.4	Master/Slave/MTCP/MUDP Data Exchange	152
5.5.5	Bits / Registers Data Exchange	153
6.	MODBUS INFORMATION	154
6.1	What is Modbus TCP/IP?.....	154
6.2	Modbus Message Structure	155
6.2.1	01(0x01) Read the Status of the Coils (Read DO Readback values)	158
6.2.2	02(0x02) Read the Status of the Input (Read DI values)	160
6.2.3	03(0x03) Read the Holding Registers (Read AO Readback values)	162
6.2.4	04(0x04) Read the Input Registers (Read AI values)	164
6.2.5	05(0x05) Force a Single Coil (Write DO value)	166
6.2.6	06(0x06) Set a Single Register (Write AO value)	168
6.2.7	15(0x0F) Force Multiple Coils (Write DO values)	170
6.2.8	16(0x10) Set Multiple Registers (Write AO values)	172
6.3	Modbus Register Table (For DIO Module).....	174

6.3.1	Common Functions	174
6.3.2	Specific Functions	176
6.4	Modbus Register Table (For AIO Module).....	180
6.4.1	Modbus Register Table for (P)ET-2215H, (P)ET-2215H-16.....	180
6.4.2	Modbus Register Table for (P)ET-2217	182
6.4.3	Modbus Register Table for ET-2217CI.....	185
6.4.4	Modbus Register Table for (P)ET-2218H/S1, (P)ET-2218H-16/S1.....	188
6.4.5	Modbus Register Table for (P)ET-2224CIS/(P)ET-2228CIS	190
6.4.6	Modbus Register Table for (P)ET-2224CI/(P)ET-2228CI	193
6.4.7	Modbus Register Table for (P)ET-2224/2228.....	196
6.5	Analog Input Type and Data Format Table.....	199
6.6	RTD Type Code Table.....	200
6.7	Thermocouple Type Code Table.....	201
APPENDIX A: TROUBLESHOOTING		202
A.1	How can I Factory Reset the Module (Password: Admin)?	202
A.2	How to update the firmware via Ethernet?	204
A.3	Why is the Host computer unable to ping or search for the ET-2200 module?	207
A.4	What is Digital-Input Filter (DI Filter)?	208

1. Introduction

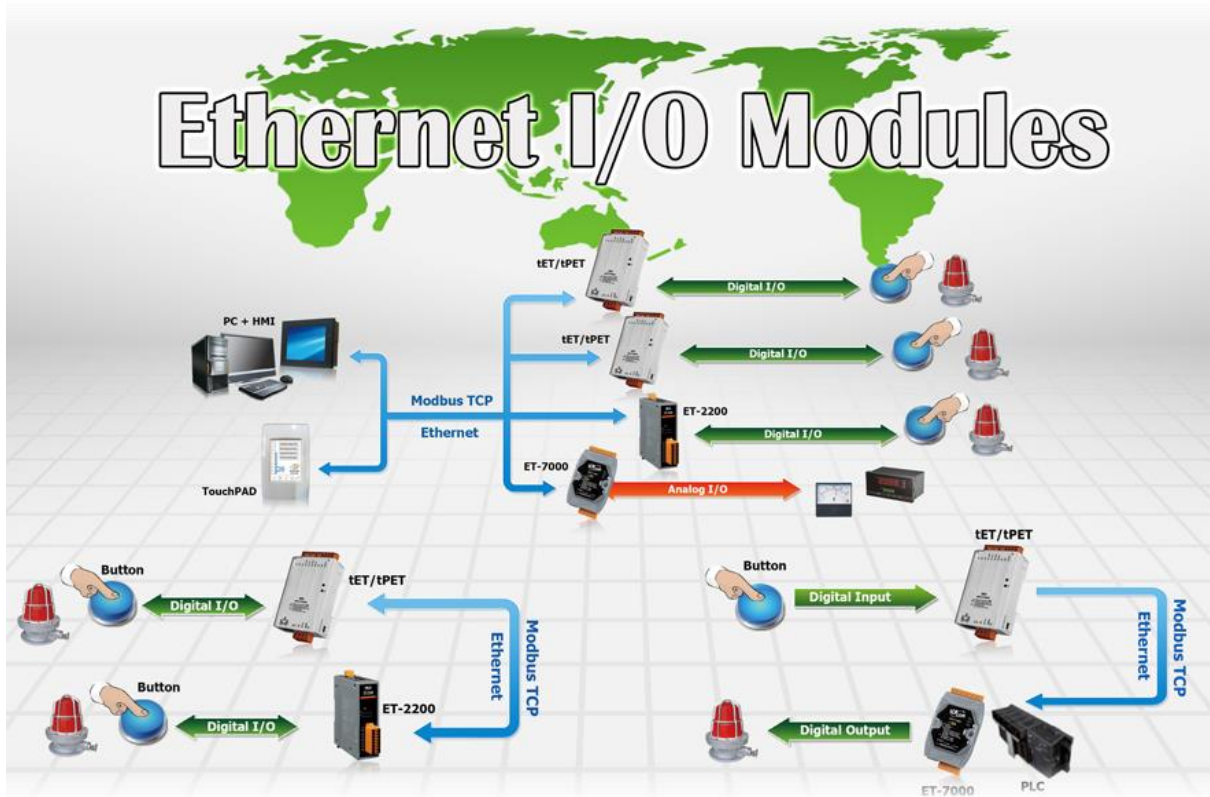

The ET-2200 series modules, an IP-based Ethernet I/O module, feature a built-in web server that allows configuration, I/O monitoring, and I/O control by simply using a regular web browser. In addition, the ET-2200 also supports Modbus TCP/UDP protocol that makes perfect integration to SCADA software.

1.1 Packing List

The shipping package includes the following items:



ET-2200 Module x 1



Quick Start x 1



Note:

If any of these items are missing or damaged, please contact the local distributor for more information. Save the shipping materials and cartons in case you need to ship the module in the future.

1.2 Features

➤ Built-in Web Server

The ET-2200 series module has a built-in web server that allows users to easily configure, monitor, and control the module from a remote location using a web browser.

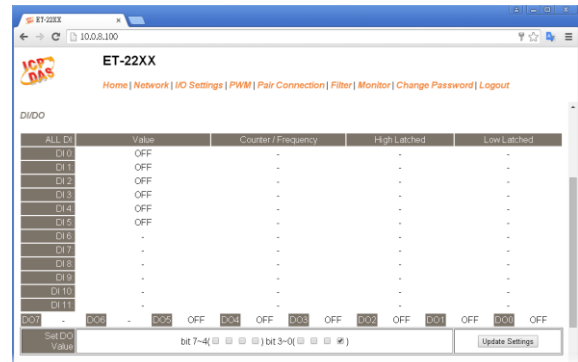

➤ Modbus TCP/UDP, MQTT, or SNMP Protocols

The Modbus TCP and Modbus UDP slave functions on the Ethernet port can be used to provide data to remote SCADA software. All DI/DO modules and some AI/AO modules support MQTT and SNMP V2c protocols.

➤ TCP Streaming

The sampling rate of **ET-2217H** is 8 KHz for all channels, and it utilizes TCP streaming continuous transmission mode to record voltage and current values.

Data Transmission Mode

● Continuous Transmission (Maximum sampling rate of 8 kHz per channel)

After starting A/D acquisition, data is continuously transmitted to the Host PC. And you can specify the required channels for collection.

Total simultaneous sampling channels	Maximum sampling rate per channel
8	1 KHz
4	2 KHz
2	4 KHz
1	8 KHz

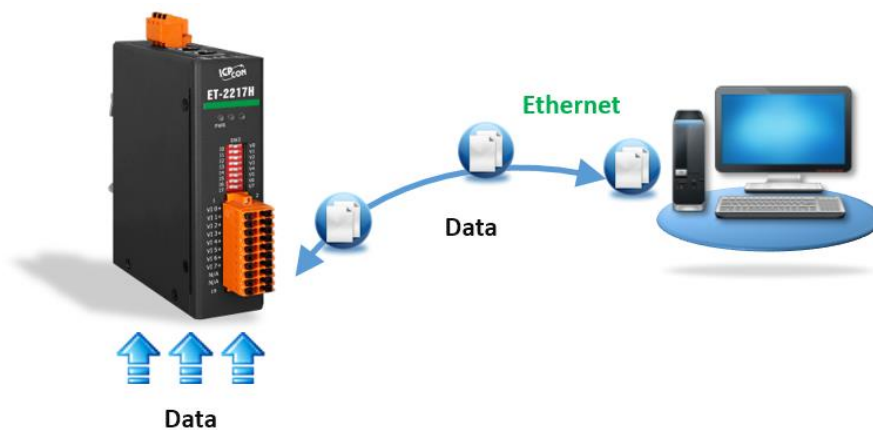

The continuous collection mode uses TCP streaming to transmit the collected data back to the PC. The streaming method of this module is that the firmware of the module uses polling scanning to sample data, and the data sampling rate is fixed. The firmware polling scanning places the data in the module buffer. When the data reaches a certain amount, it is automatically sent to the host. The host sends a start collection command, and the module uses large data packets according to the above method, sending each packet to the host until the host sends a stop collection command to stop collecting data.

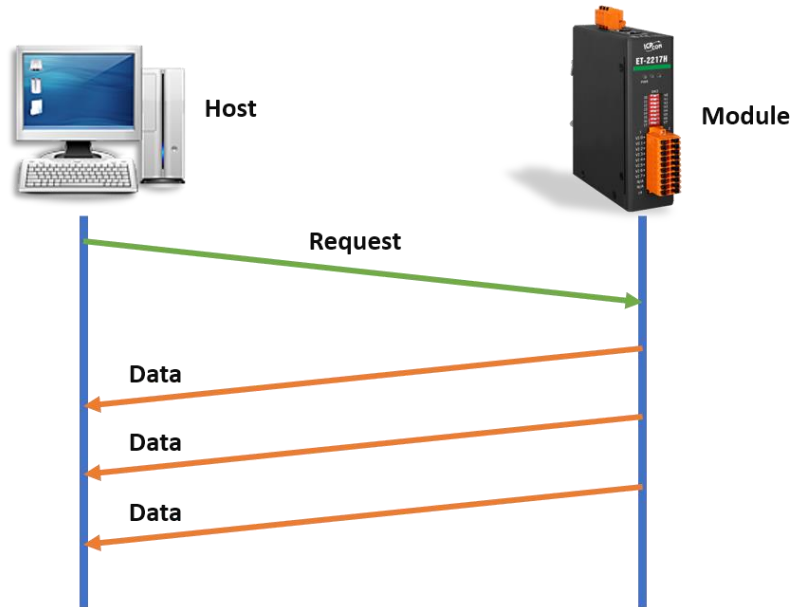

● **Modbus/TCP (Command Response Mode)**

This mode of the Modbus/TCP protocol is a commonly used communication method for acquisition modules. The firmware of the acquisition module will collect data at a fixed sampling rate and temporarily store it in the module memory (Modbus Register table). When the host sends a command to the module, the module will send the temporarily stored relevant data back to the host as needed.

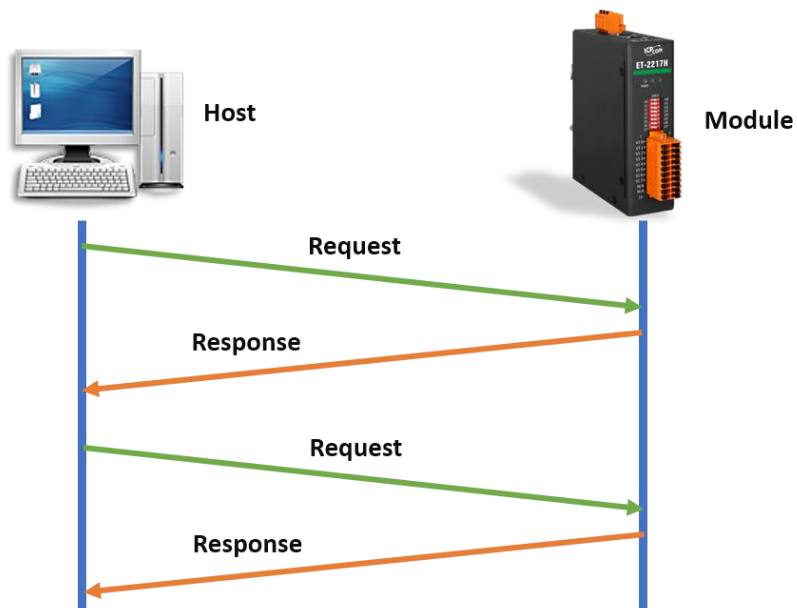

● PC 軟體規格

PC 軟體	
Support OS	Windows 7/8/10/11 and Linux
Utility	Configuration, graphically display and data logging
SDK	<p><u>Windows</u></p> <ul style="list-style-type: none"> Microsoft VC, C#, VB.NET SDK API and Demo Python Demo NI LabVIEW Toolkit and Demo <p><u>Linux</u></p> <ul style="list-style-type: none"> C/C++ library and Demo .NET library and Demo Python Demo

➤ I/O Pair Connection (Push and Pull)

This function is used to create a DI to DO pair through the Ethernet. Once the configuration is completed, the ET-2200 module can continuously pull the status of the remote DI device using the Modbus TCP protocol and then write to local DO channels in the background.

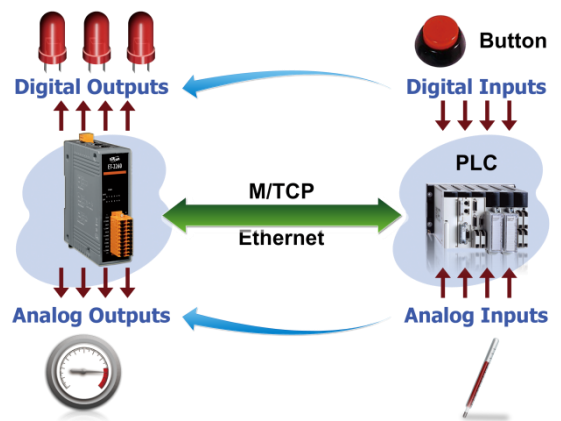

➤ Slim-Type Housing

The ET-2200 modules are slim-type housing with about 3.3 cm in width. Compared with the palm-size module that has about 7 cm in width, more slim-type ET-2200 modules can be installed on the same DIN-Rail space.

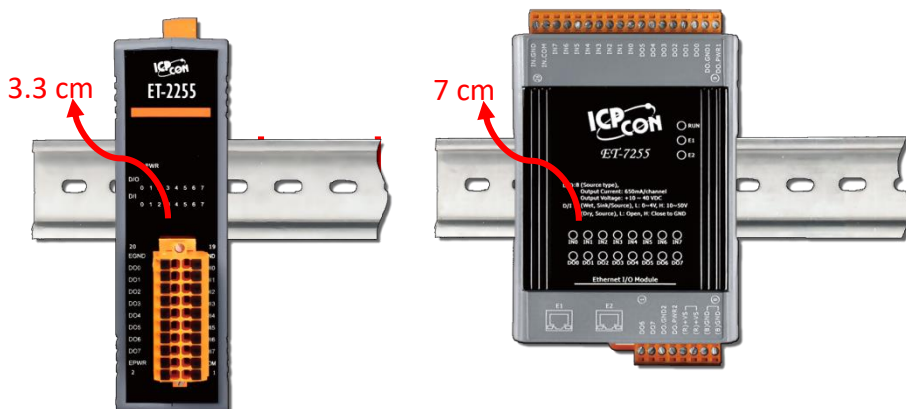

➤ Built-in Multi-function I/O

The **DO** modules support these functions:

- **Power-on Value:** On boot up, the DO value will be set to the Power-on value.
- **Safe Value:**
If Modbus TCP communication is lost for a specific period, the DO value will be set to the user-defined safe value.
- **A PWM (Pulse-Width Modulation) Function:**
Each of DO channel can be set to a different frequency (100 Hz Max.) and duty cycle, also work either independently or simultaneously. The term “High Duty Cycle” describes the duration of 'ON' time in proportion to the regular interval or 'period' of time. Similarly, the term “Low Duty Cycle” corresponds to the duration of the 'OFF' time. Consequently, it is not necessary to keep switching from ON to OFF from remote a controller. In this way, the module reduces the complexity required for the control system and enhances timing accuracy.
Note: Because of the characteristics of the relay functions, it is recommended that the PWM on modules with relay functions is not used for extended periods.

The **DI** modules support these functions:

- **Can be Used as a 32-bit High Speed Counter**
- **High/Low Latched Status Commands:**

The modules provide commands to read the status of any digital input channels that are latched high or latched low. The following is an example that shows the usefulness of the latched digital input. If we wish to read a key stroke from a key switch connected to the digital input channel of a module, the input signal of the key stroke is a pulse signal as shown in the figure.

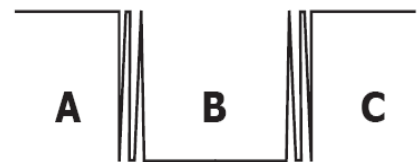

If we just use the read digital input status command to read the signal and we cannot send the command during the B period due to some reasons, then we will lose the key stroke information. However, with the read latched digital input command, we can still get the key stroke information even we are not able to send command in B period.

- **Frequency Measurement:**
This function can be used to retrieve the digital input counter value at specific times and calculates the frequency. Rather than polling via a remote host, the module can determine the frequency directly, reducing the communication delay caused by two ends and also improves the accuracy of the frequency measurement. In order to applying for more applications, this module provides 3 scan modes and 4 moving average methods for user to select the best way in their applications.

➤ **DIO Synchronization (Mirror Local DI to DO):**

The module also provide a DIO synchronization function. The DIO synchronization is divided into three modes: **Level Sync**, **Rising Active**, and **Falling Active**.

Level Sync (DO = DI) Mode:

The synchronization operation in DI and DO.

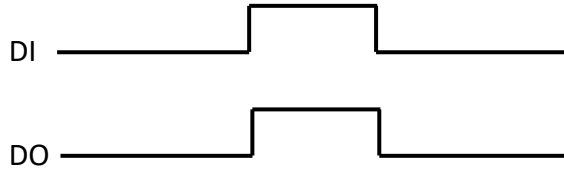

Rising Active (DO = ON) Mode:

When the specified DI state is from OFF to ON, the corresponding DO will be set to ON.

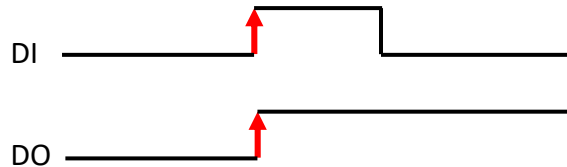

Falling Active (DO = ON) Mode:

When the specified DI state is from ON to OFF, the corresponding DO will be set to ON.

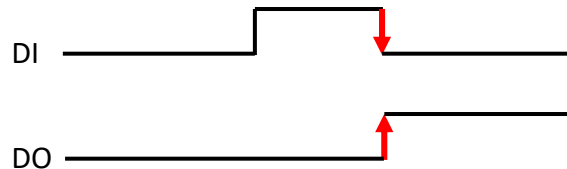

➤ **Built-in Dual Watchdog**

The Dual Watchdog consists of a CPU Watchdog (for hardware functions) and a Host Watchdog (for software functions).

CPU Watchdog automatically resets itself when the built-in firmware runs abnormally.

Host Watchdog set the digital output with a predefined safe value when there is no communication between the module and host (PC or PLC) over a while (Watchdog timeout).



➤ Daisy-chain Ethernet Cabling

The ET-2200 has a built-in two-port Ethernet switch to implement daisy-chain topology. The cabling is much easier and the total costs of cable and switch are significantly reduced.

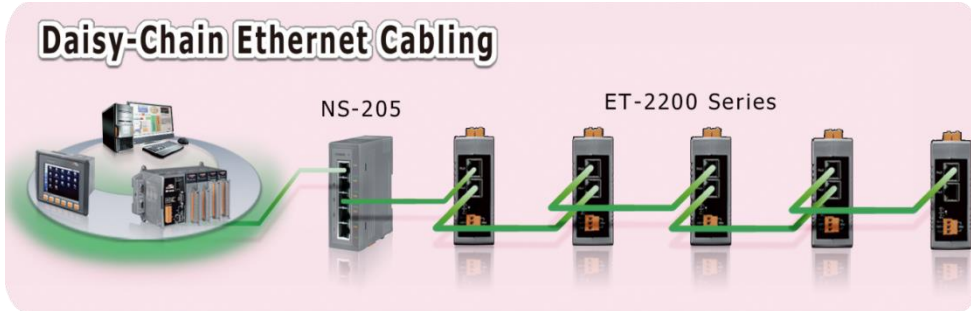

➤ LAN Bypass

LAN Bypass feature guarantees Ethernet communication. It will automatically be active to continue the network traffic when the ET-2200 loses its power.

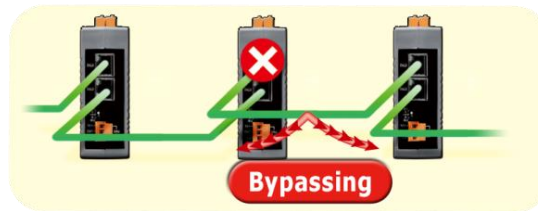

➤ Highly Reliable Under Harsh Environment

- Wide Operating Temperature Range: -25 ~ +75°C
- Storage Temperature: -40 ~ +80°C
- Humidity 10 ~ 90% RH (Non-condensing)



1.3 Application

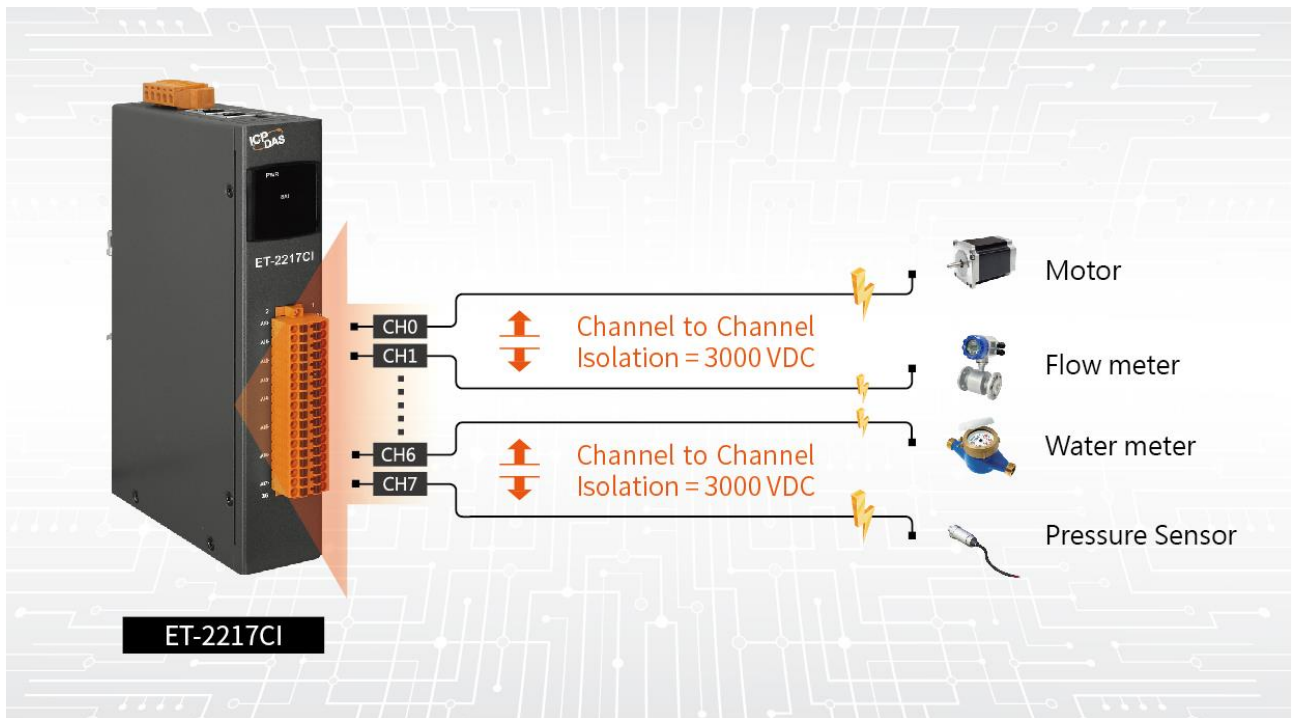

2. Hardware Information

2.1 Appearance

The components of the ET-2200 module include LED indicators, pluggable terminal blocks for I/O or power input, an operating mode switch, and Ethernet ports.

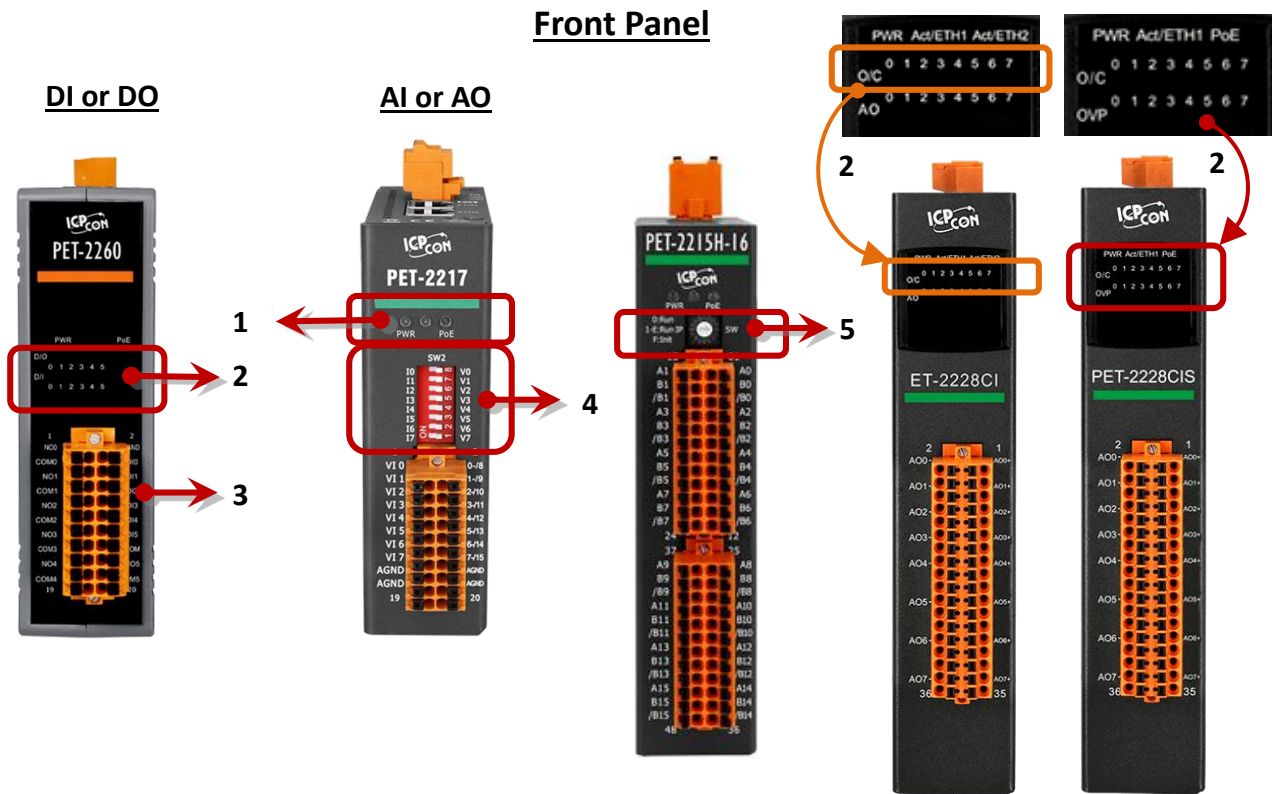

AI or AO

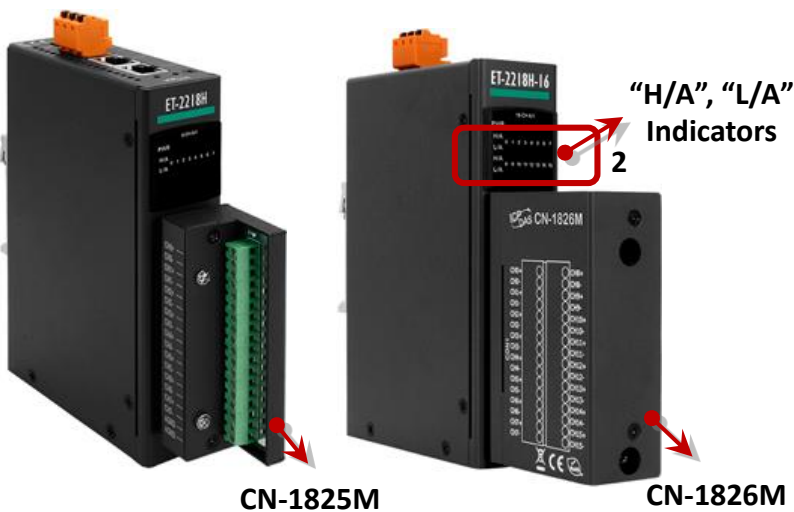

CN-1825M

CN-1826M

1	PWR / PoE LED Indicator
2	I/O Indicator
3	I/O Connector
4	DIP Switch
5	Rotary Switch

1) PWR or PoE LED Indicator

Once power is supplied to the ET-2200 series module, the PWR LED indicator will illuminate.

Note: PoE (Power-over-Ethernet) indicator is only available for the PET-2000 series modules

2) I/O Indicator

Some modules provide I/O indicators, which light up when the status is ON.

For (P)ET-2218H/S1, (P)ET-2218H-16/S1 series, the "H/A" LED lights up when the measured temperature exceeds the maximum value of the specified range or if the channel is disconnected. If the temperature is lower than the minimum value, the "L/A" LED lights up. For example, Type M, -200 to 100 °C.

For (P)ET-2224CI/2228CI and (P)ET-2224CIS/2228CIS, the "O/C" indicator is used for open wire detection. The LED will light up if the current output channel is disconnected.

For (P)ET-2224CIS/(P)ET-2228CIS series, the "OVP" LED lights up when the over-value protection is triggered. Refer to [Section 4.2.4 OVP \(Over-value Protection\) Mechanism](#)

3) I/O Connector

The pin assignments for the I/O connector on the ET-2200 series module differ based on the model. For more information about pin assignments, refer to [Section 2.3 "Pin Assignments"](#).

4) DIP Switch

The DIP switch of the (P)ET-2217 and (P)ET-2217H can be used to set I/O channels as voltage or current inputs.

5) Rotary Switch

The rotary switch of the (P)ET-2215H, (P)ET-2215H-16, (P)ET-2218H/S1, (P)ET-2218H-16/S1, (P)ET-2224CI, (P)ET-2228CI, (P)ET-2224P, and (P)ET-2228P can be used to set the operating mode.

Run Mode:

0 : User specified IP or DHCP

1-E : Default IP, 192.168.255.1 ~ 14

Init Mode:

F : Factory default, Firmware Update

Top Panel



AI/AO (ET-2200CI)

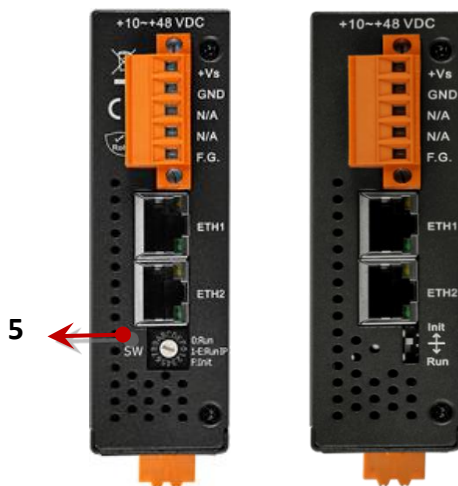

5	Rotary Switch
6	Power Input Connector
7	Operating Mode Switch
8	2-Port Ethernet Switch
9	Ethernet Cable Locking Hole

6) DC Power Input Connector

The power input connector on the ET-2200 series module differs in pin assignments base on the model. For more information about pin assignments, refer to [Section 2.3 “Pin Assignments”](#)

DC Power Input:

All ET-2200 series modules include “(R)+Vs” and “(B)GND” pins and are powered by a DC power supply. The valid power voltage range is from **+10 to +30 VDC** or **+10 to +48 VDC**. (Refer to Section 2.2.1)

Frame Ground (F.G.):

In continental climate zones, electronic circuits are susceptible to electrostatic discharge (ESD). The ET-2200 series modules adopt a new frame grounding design to provide an ESD discharge path, thus preventing static electricity and environmental interference from directly affecting the hardware. This improvement ensures enhanced protection against ESD (Electrostatic Discharge), making the module more reliable.

7) Operating Mode Switch

Init mode:

For firmware update or troubleshooting. The factory presets will be loaded.

Run mode:

For normal operation. The user-defined configuration will be loaded. The factory default is set to "Run". Refer to [Section 3.1 "Configuring the Boot Mode"](#) for more information.

8) 2-Port Ethernet Switch

The (P)ET-2200 series modules are equipped with two RJ-45 10/100 Base-TX Ethernet switch ports. When an Ethernet link is detected and an Ethernet packet is received, the **Green LED** indicator will be illuminated. While the **Yellow LED** indicator is used for the PoE module.

9) Ethernet Cable Locking Hole

The (P)ET-2215H and (P)ET-2215H-16 series include the locking holes for the Ethernet cable to prevent accidental loosening.

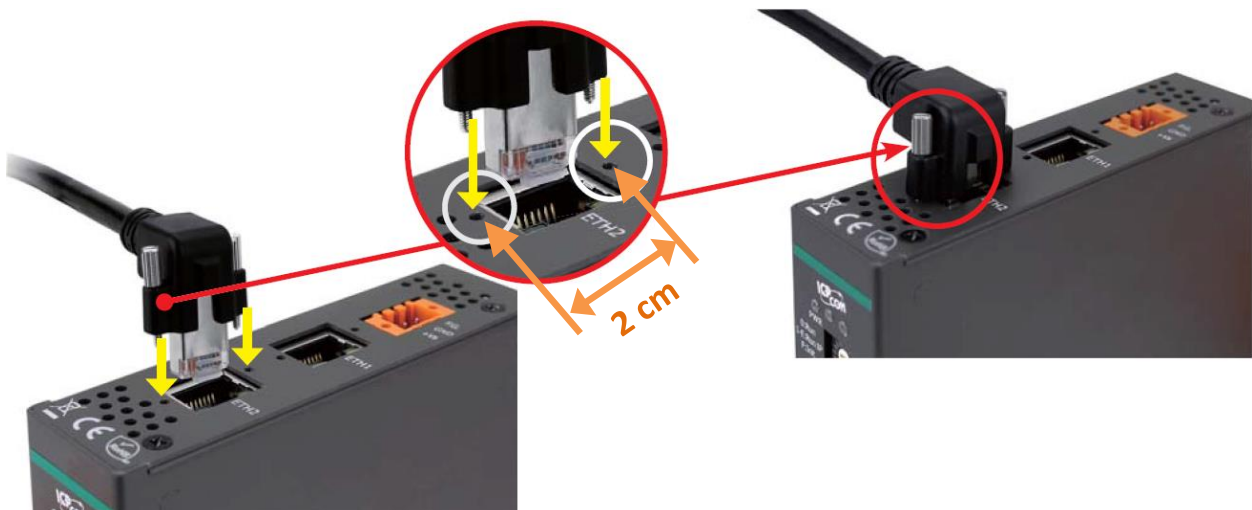

2.2 Specification

Product Page

The user can enter the model in the search bar on the website (<https://www.icpdas.com/>) to find out the product page.

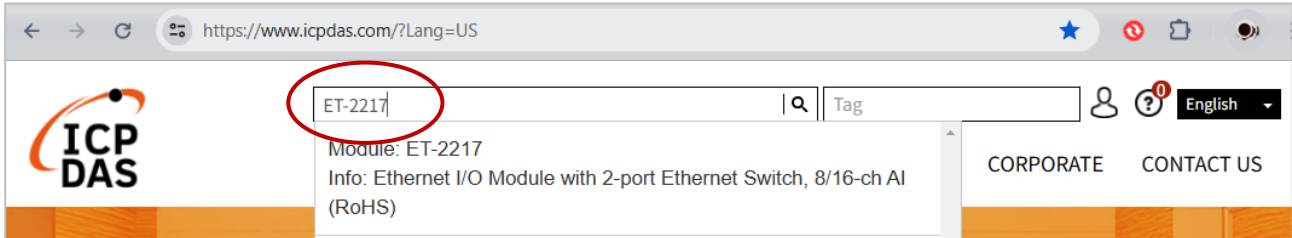

ET-2200 Selection Guide:

https://www.icpdas.com/en/product/guide+Remote_I_O_Module_and_Unit+Ethernet_I_O_Modules+ET-2200#2724

HOME > PRODUCTS > Remote I/O Module and Unit > Ethernet I/O Modules > ET-2200

Introduction Selection Guide Ethernet I/O Comparison Table

▶ Available soon ▶ Will be phased out ▶ Phased out

Analog Input Modules

Model	AI					Protocol	
	Channels	Sampling Rate	Voltage & Current Input	Sensor Input	Channel to Channel Isolation	MQTT	SNMP V2c
ET-2217CI-4 ▶	-	10/200Hz, for each channel	±1 V, ±2.5 V, ±5 V, ±10 V, ±20 mA,	-	Yes	Yes	-
ET-2217CI new	4						
ET-2217 ▶	PET-2217 ▶	8/16	20/200Hz	±150 mV, ±500 mV, ±1 V, ±2.5 V, ±5 V, ±10 V, ±20 mA, 0 ~ +20 mA, +4 ~ +20 mA	-	-	Yes

Also, click the “Data Sheet” icon on the product page to find out the information on Dimensions, Pin Assignments, and Wire Connections.

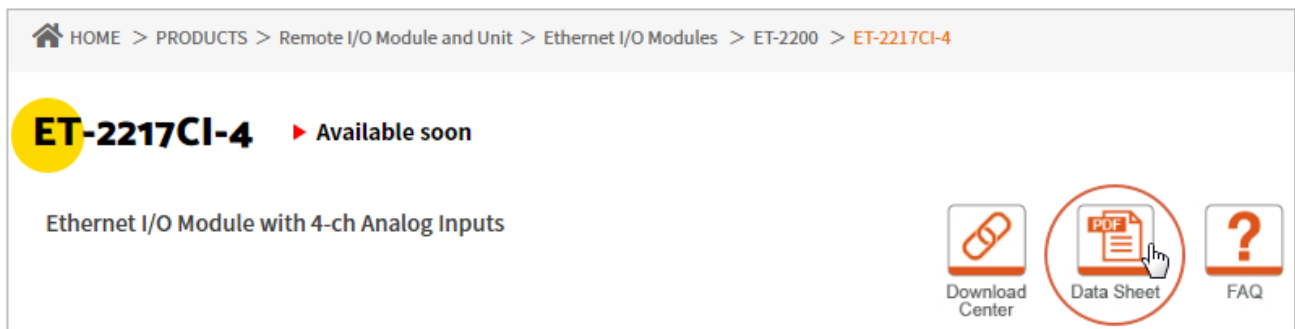

Data Sheet:

The following table lists the URL of the data sheet for the relevant models.

Model	File Name
www.icpdas.com/web/product/download/io_and_unit/ethernet/et2200/document/data_sheet/	
Analog Input Modules	
ET-2217, PET-2217	(P)ET-2217_en.pdf
ET-2217H, PET-2217H	(P)ET-2217H_en.pdf
ET-2217CI-4, ET-2217CI	ET-2217CI-4_ET-2217CI_en.pdf
ET-2215H, PET-2215H, ET-2215H-16, PET-2215H-16	(P)ET-2215H_(P)ET-2215H-16_en.pdf
ET-2218H/S1, PET-2218H/S1, ET-2218H-16/S1, PET-2218H-16/S1	(P)ET-2218H(-16)_S1_en.pdf
Analog Output Modules	
ET-2224, PET-2224, ET-2228, PET-2228	(P)ET-2224_(P)ET-2228_en.pdf
ET-2224P, PET-2224P, ET-2228P, PET-2228P	(P)ET-2224P_(P)ET-2228P_en.pdf
ET-2224CI, PET-2224CI, ET-2228CI, PET-2228CI	(P)ET-2224CI_(P)ET-2228CI_en.pdf
ET-2224CIS, PET-2224CIS, ET-2228CIS, PET-2228CIS	(P)ET-2224CIS_(P)ET-2228CIS_en.pdf
Digital I/O Modules	
ET-2242, PET-2242	(P)ET-2242_en.pdf
ET-2242U, ET-2242U-32, PET-2242U-32	ET-2242U_(P)ET-2242U-32_en.pdf
ET-2251, PET-2251, ET-2251-32, PET-2251-32	(P)ET-2251_(P)ET-2251-32_en.pdf
ET-2254, PET-2254, ET-2254P, PET-2254P	(P)ET-2254_(P)ET-2254P_en.pdf
ET-2255, PET-2255, ET-2255-32, PET-2255-32	(P)ET-2255_(P)ET-2255-32_en.pdf
ET-2255U, PET-2255U	(P)ET-2255U_en.pdf
Relay Output/Digital Input Modules	
ET-2260, PET-2260	(P)ET-2260_en.pdf
ET-2261, PET-2261	(P)ET-2261_en.pdf
ET-2261-16	ET-2261-16_en.pdf
ET-2268	ET-2268_en.pdf

2.3 Wiring Connections

The user can find out the Wire Connections diagram for each model in the data sheet on the website.

Wire Connections

Relay Output	ON State Readback as 1	OFF State Readback as 0
Form A Relay in NO1, NO3, NO4, NO7		
Form C Relay in NO0, NO2, NO4, NO6		

Note for the ET-2260/2261/2261-16/2268:

When inductive loads are connected to the relays, a large counter-electromotive force may occur when the relay actuates because of the energy stored in the load. These flyback voltages can severely damage the relay contacts and greatly shorten the relay life. To achieve circuit protection and control flyback voltages in your inductive load, install a flyback diode for DC loads or a metal oxide varistor for AC loads.

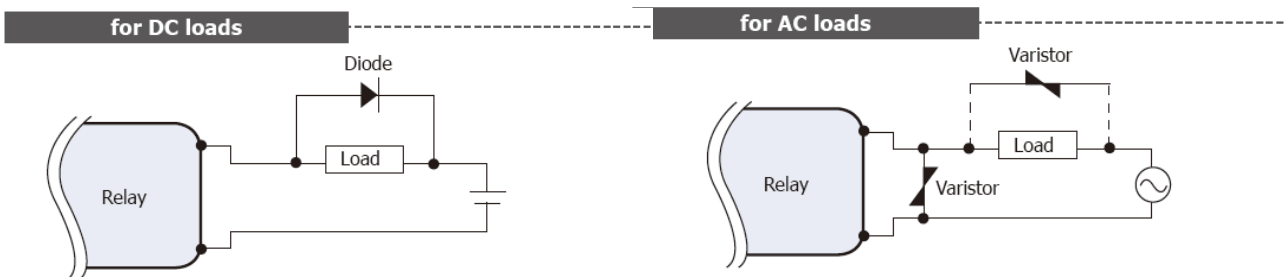

Varistor Selection:

Operating Voltage	Varistor Voltage	Max. Peak Current
100 ~ 120 V _{AC}	240 ~ 270 V _{AC}	> 1000 A
200 ~ 240 V _{AC}	440 ~ 470 V _{AC}	> 1000 A

2.4 Wiring to the Connector

- Insulated Terminals Dimensions (Unit: mm):

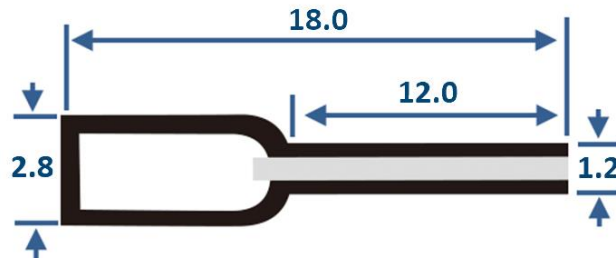

- A tip for connecting or removing the wire to the connector:

1. Use the blade of the flat-head screwdriver to push down the wire clamp.

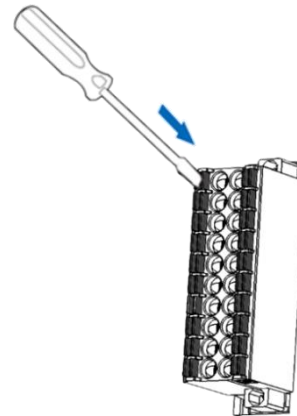

2. While holding the screwdriver in place, **insert or remove** the wire into the terminal block.

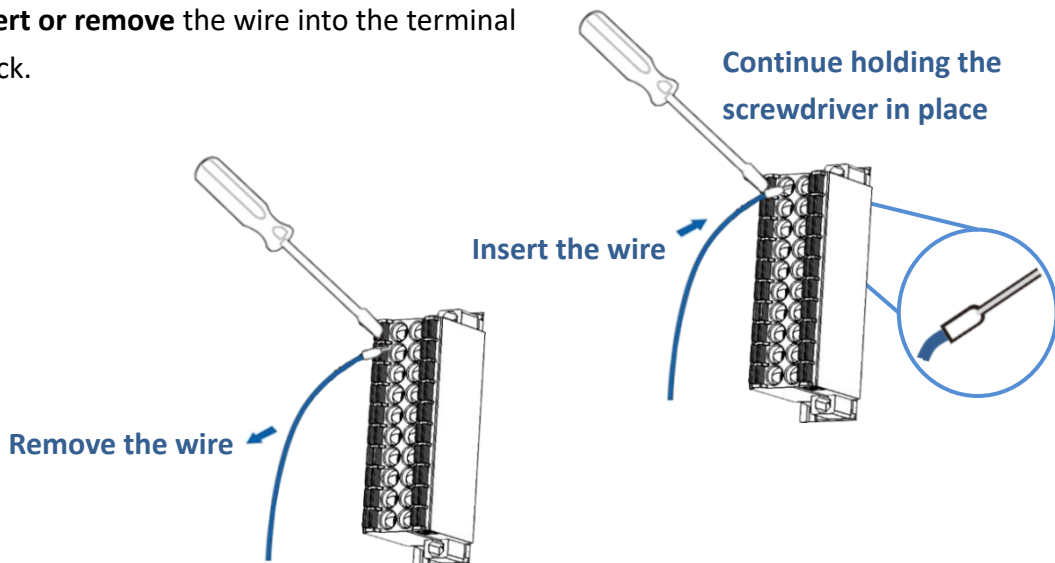

2.5 Dimensions

The following diagrams provide the dimensions of the ET-2200 series module and can be used as a reference when defining the specifications for any custom enclosures. All dimensions are in millimeters.

➤ **(P)ET-2215H**

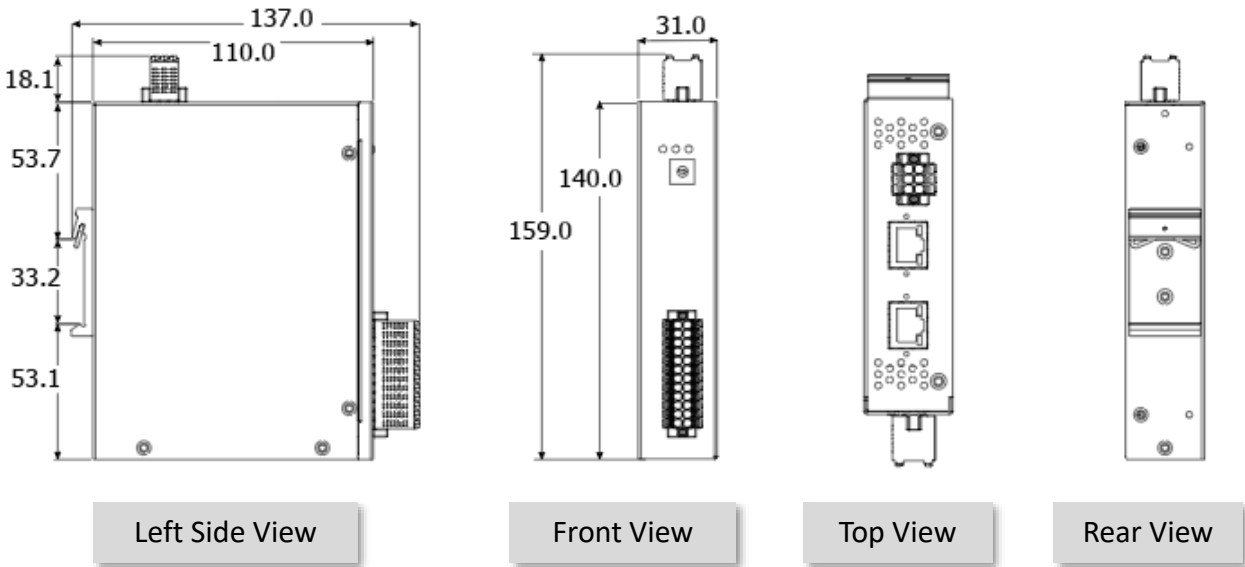

➤ **(P)ET-2215H-16:**

Note: the top view and rear view are the same with the (P)ET-2215H.

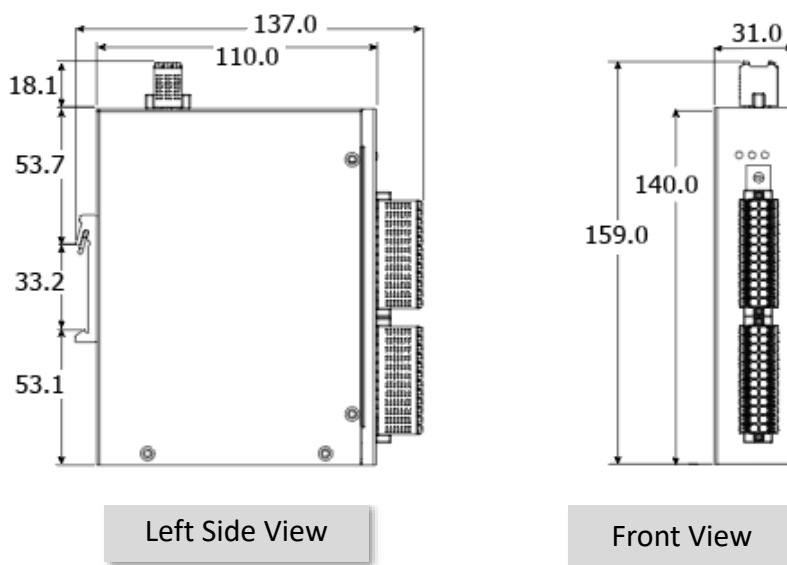

➤ **(P)ET-2218H/S1 = (P)ET-2218H + CN-1825M**

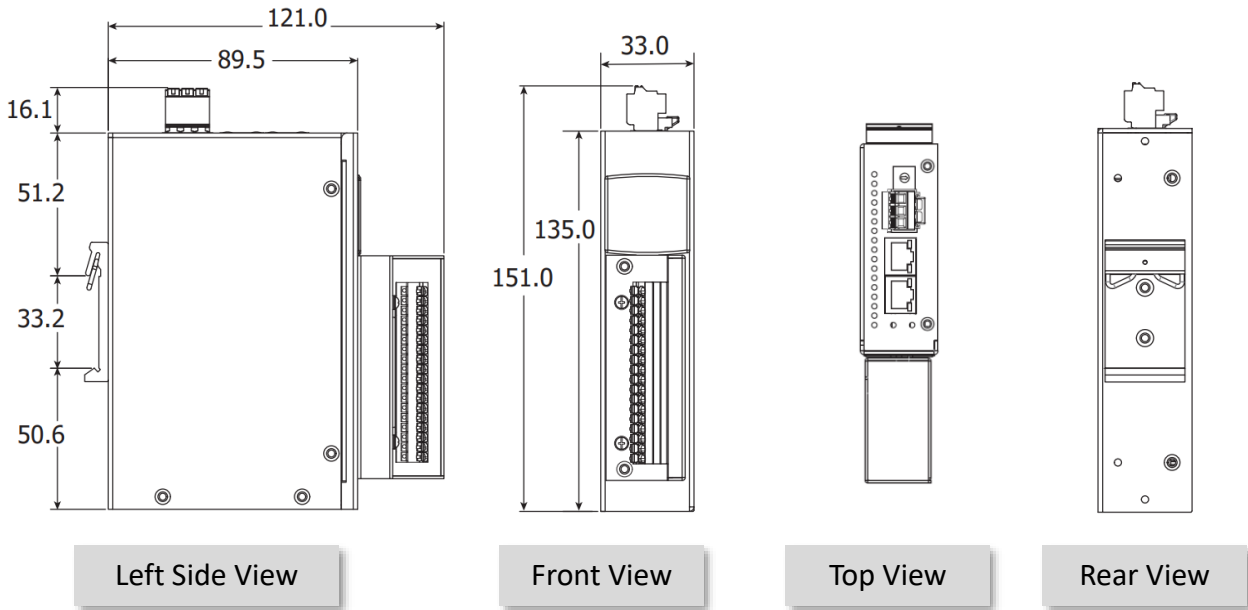

➤ **(P)ET-2218H-16/S1 = (P)ET-2218H-16 + CN-1826M**

Note: the top view and rear view are the same with the (P)ET-2218H/S1.

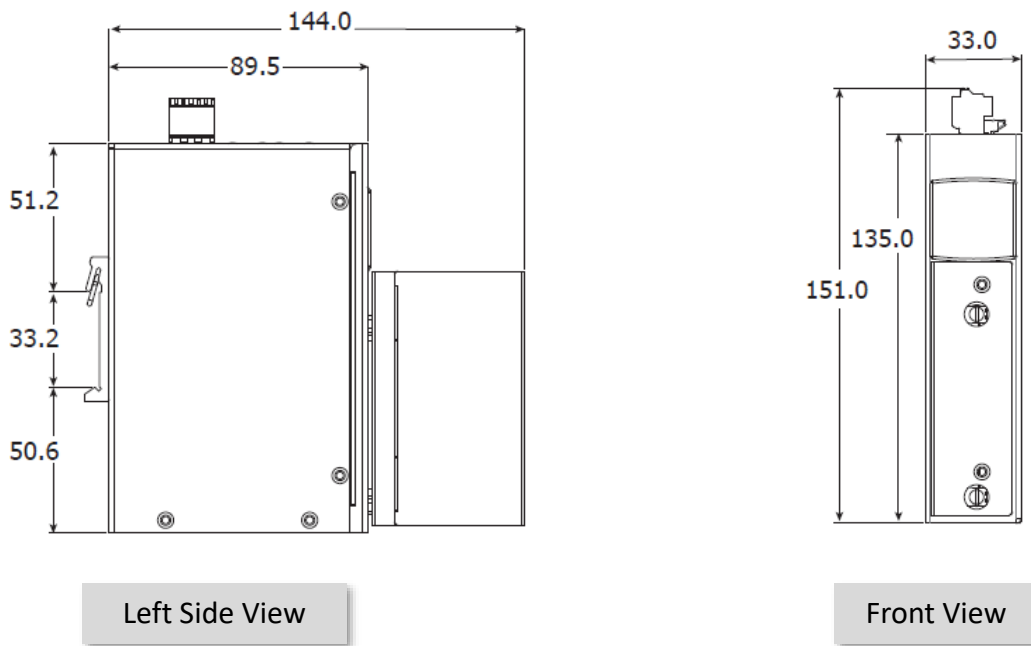

➤ **(P)ET-2217, (P)ET-2217H:**

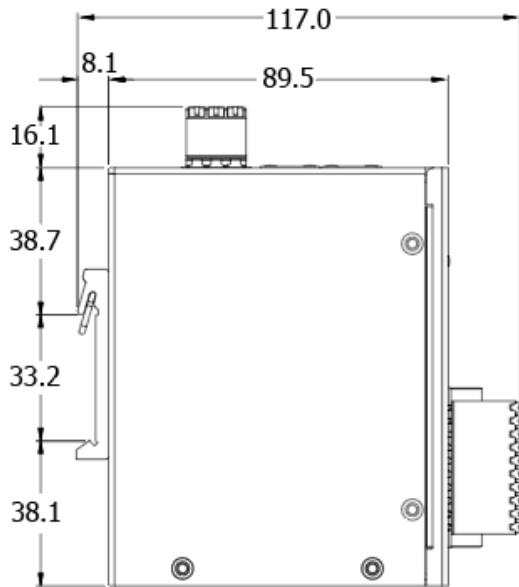

Left Side View

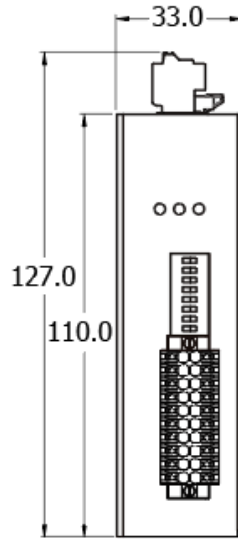

Front View

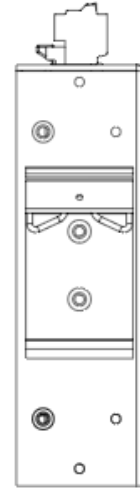

Rear View

➤ **(P)ET-2224, (P)ET-2228, (P)ET-2224P, (P)ET-2228P**

Note: the left side view and rear view are the same with the (P)ET-2217.

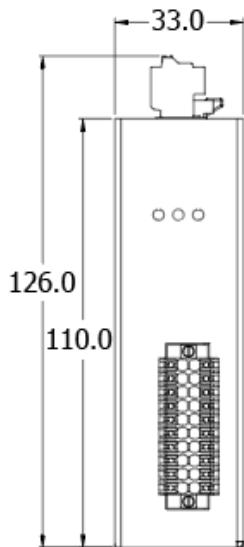

Front View

➤ **(P)ET-2217,
(P)ET-2224,
(P)ET-2228**

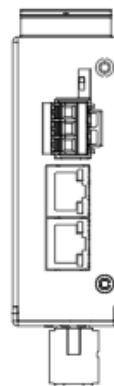

Top View

➤ **(P)ET-2217H,
(P)ET-2224P,
(P)ET-2228P**

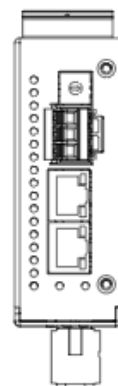

➤ ET-2217CI, ET-2217CI-4, (P)ET-2224CI, (P)ET-2228CI, (P)ET-2224CIS, (P)ET-2228CIS:

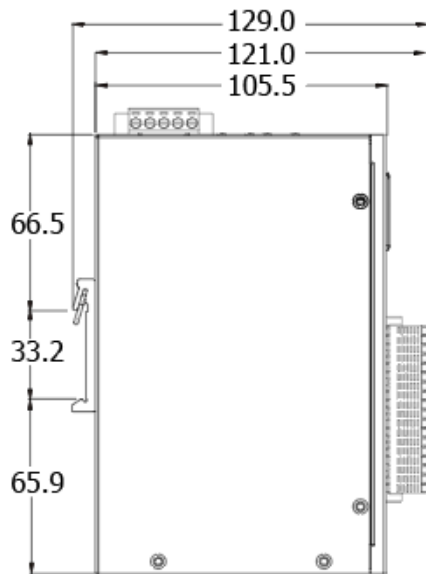

Left Side View

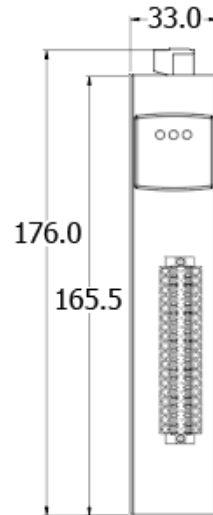

Front View

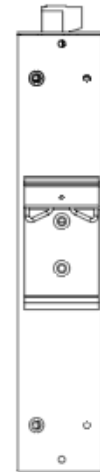

Rear View

➤ ET-2217CI, ET-2217CI-4

➤ (P)ET-2224CI, (P)ET-2228CI
(P)ET-2224CIS, (P)ET-2228CIS

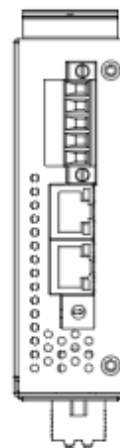
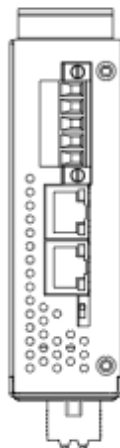

Top View

- (P)ET-2242, ET-2242U, (P)ET-2254, (P)ET-2255, (P)ET-2255U, (P)ET-2260, (P)ET-2261, ET-2268:

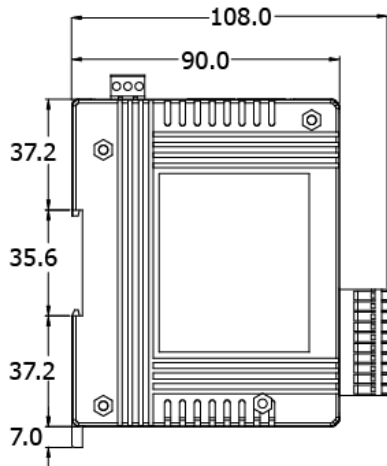

Left Side View

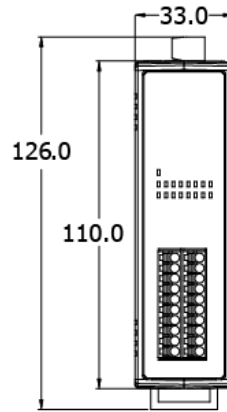

Front View

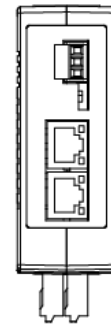

Top View

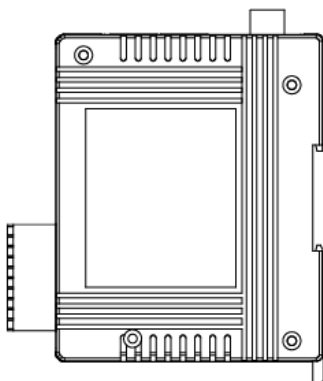

Right Side View

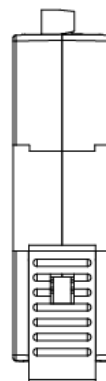

Rear View



Bottom View

➤ (P)ET-2242U-32, (P)ET-2251-32, (P)ET-2255-32, ET-2261-16:

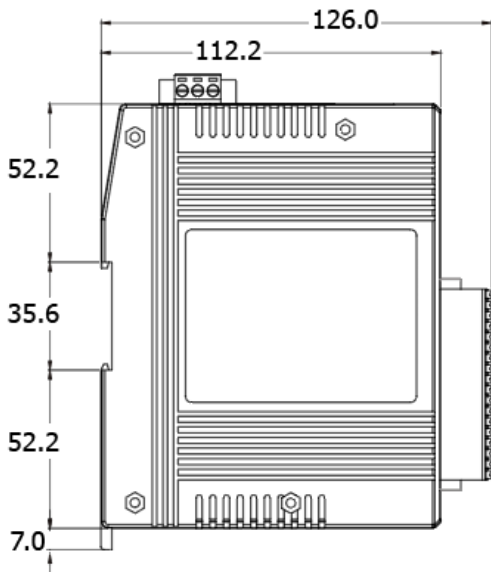

Right Side View

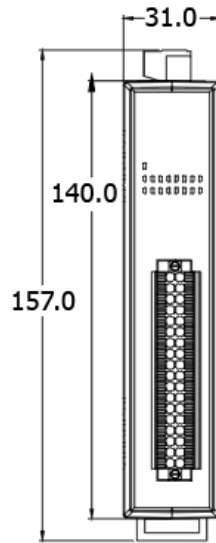

Front View

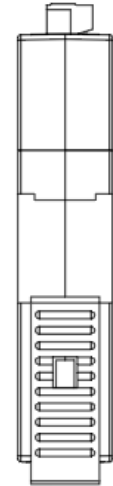

Rear View

➤ (P)ET-2242U-32

➤ ((P)ET-2251-32, (P)ET-2255-32, ET-2261-16

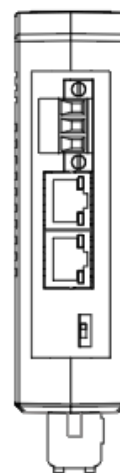
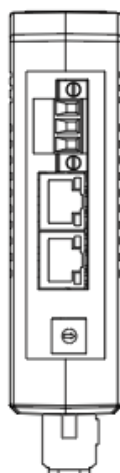

Top View

3. Getting Started

This chapter provides a basic overview of how to configure and operate your ET-2200 series module.

3.1 Configuring the Operating Mode

All ET-2200 series modules feature two operating modes, which can be selected by adjusting the switch on the module. **Note that it is necessary to reboot the module after modifying the operating mode.**

Init Mode

The Init Mode should be chosen when updating the firmware or conducting troubleshooting. In this mode, the configurations of the module will be forced to the default factory settings.

Run Mode

Run Mode is the default operating mode and should be used in most cases.



Note

1. After updating the firmware, be sure to set the switch back to the "Run" position and reboot the module.
2. If the user cannot log in to the module's web server or forget the password, please refer to [Appendix A](#) to restore the factory default settings.

3.2 Connecting to the Network and the PC

All ET/PET-2200 series module are equipped with an RJ-45 Ethernet port to allow connecting to an Ethernet switch/hub or a PC.

Uses Non-PoE Switch

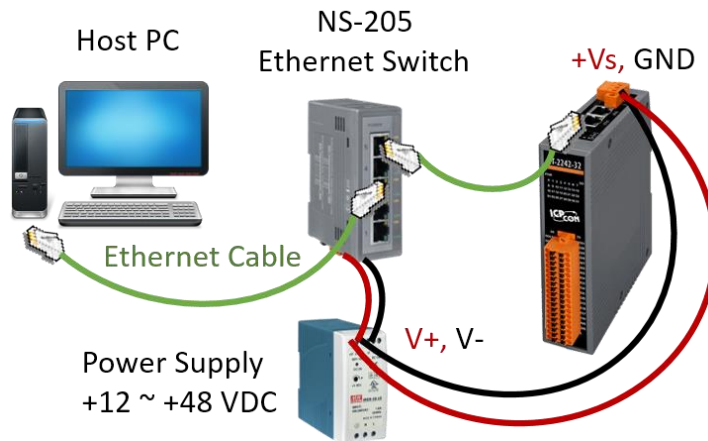

Uses PoE Switch (for PET-2200 only)

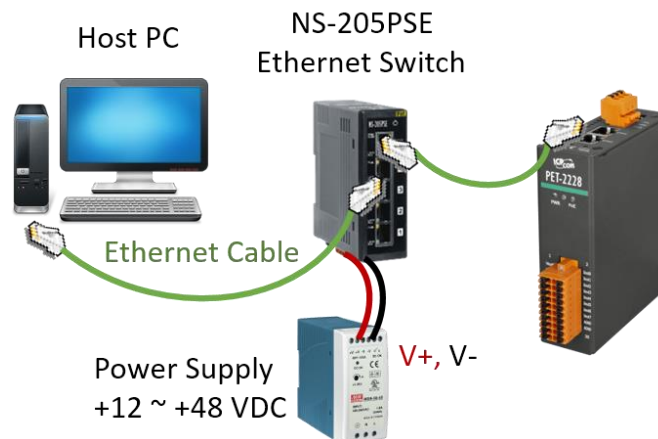

Note:

- 1) Before configuring the network, make sure that the ET-2200 and the PC are on the same sub-network.
- 2) The valid range of power input for ET-2200 series modules will be different based on the model. For example, 10-30 VDC or 10-48 VDC.
- 3) Confirm that the PWR LED indicator on the front panel of the module is flashing.

3.3 Configuring the Network Settings

The **eSearch Utility** is a useful tool that provides a quick and easy method of configuring the Ethernet settings for the module from a PC.

Step1. Get the eSearch Utility

The eSearch Utility can be obtained from the ICP DAS website at:

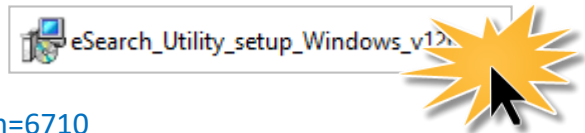

<https://www.icpdas.com/tw/download/show.php?num=6710>

Step2. Install the eSearch Utility

Follow the setup wizard's instructions to complete the installation.

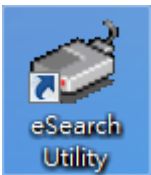

Once the installation is finished, a desktop shortcut for the eSearch Utility will appear.

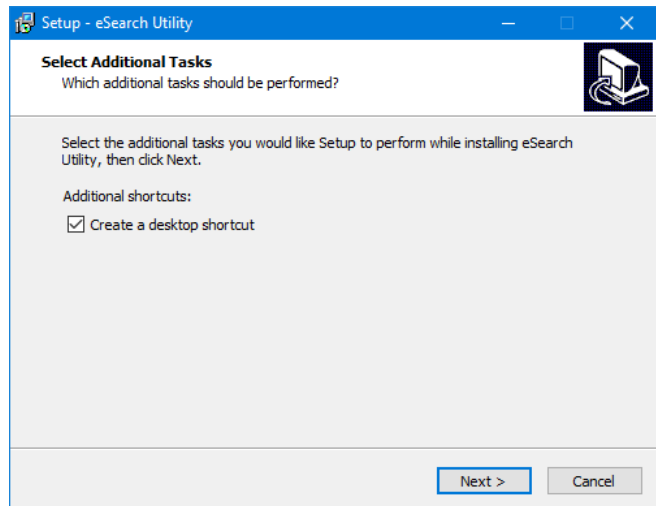

Double-click the icon to run eSearch Utility.

Step3. Click the "Search Server" button to search for your module double-click the module name to start network settings

The factory settings of the module are as follows:

IP Address **192.168.255.1** Subnet Mask **255.255.0.0** Gateway **192.168.0.1**

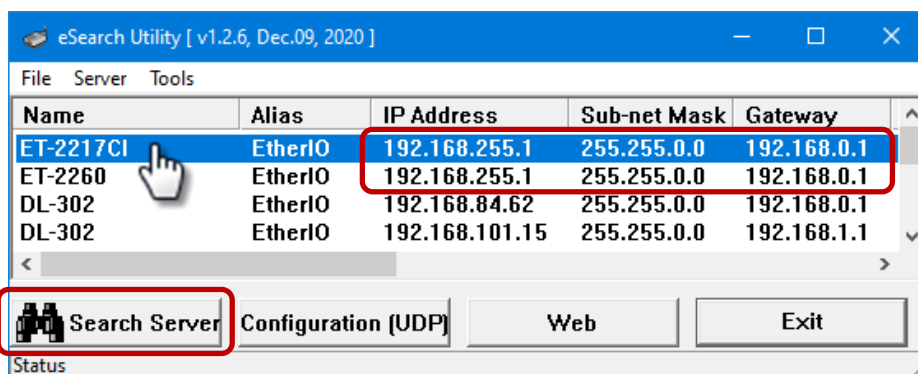

Step4. Configure the network settings and click the “OK” button.

Contact your Network Administrator to obtain the correct network configuration information. Modify the network settings and click the “OK” button to save the changes.

Note: Make sure that the IP addresses of the PC and the module are on the same sub-network.

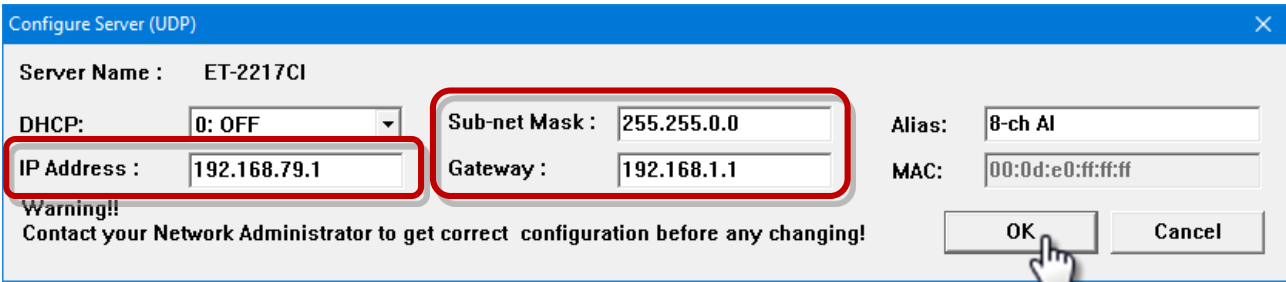

Step 5: Search the module again and check the settings

Click the “Search Server” button to search the module again and check the settings are correct.

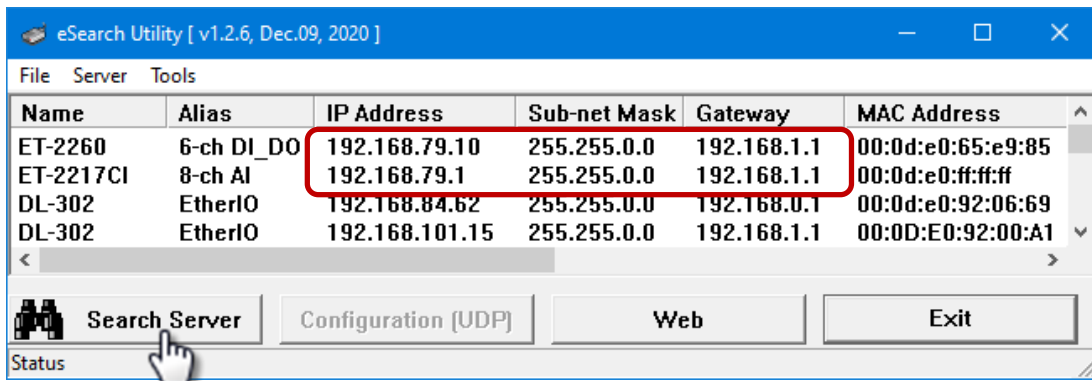

3.4 Modbus TCP Testing

Step1. In the eSearch Utility, Select the “**Modbus TCP Master**” item from the “**Tools**” menu to open the Modbus TCP Master Utility.

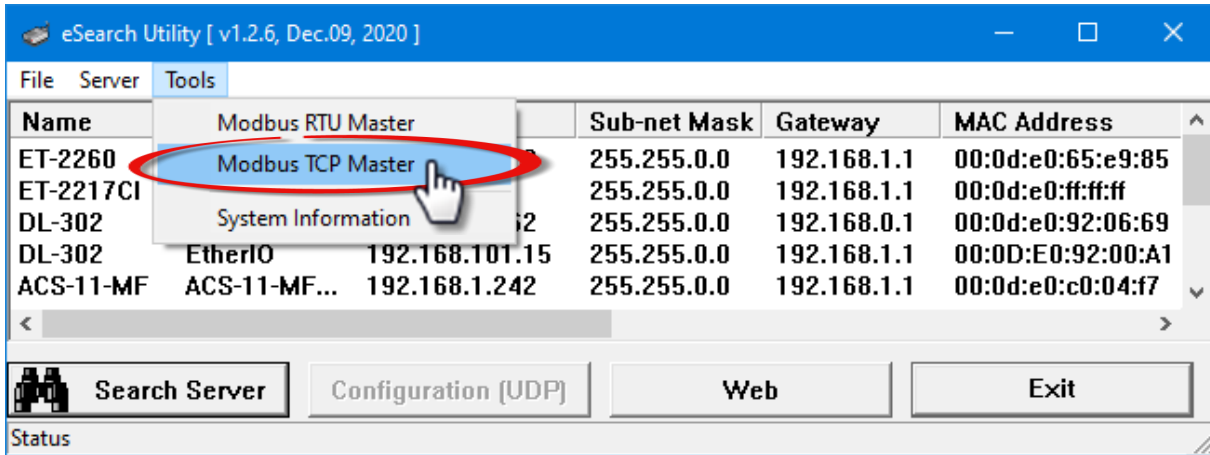

Step2. Enter the IP address and TCP Port for the ET-2200 module in the “**Modbus TCP**” section, and then click the “**Connect**” button to connect to the ET-2200.

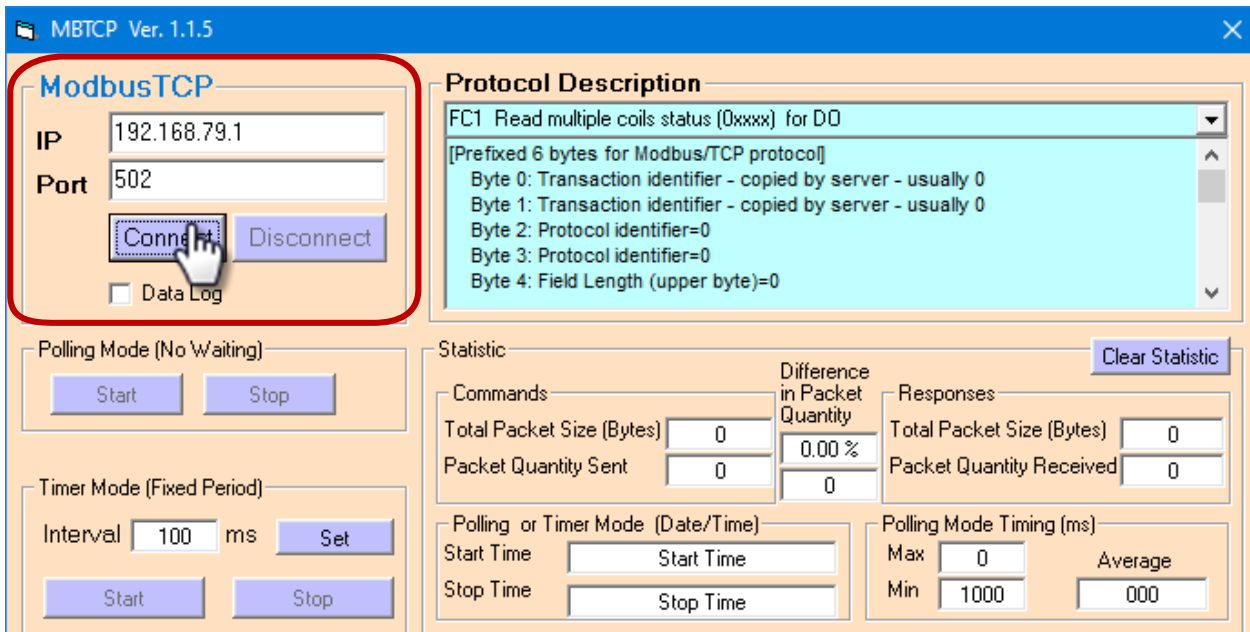

Step3. Refer to the “Protocol Description” field in the top right-hand section of the Modbus Utility windows. You can send a request command and confirm that the response is correct.

Example:

The Modbus NetID for the ET-2200 is 1 (refer to Section 4.3.1). Please send the command “1 2 0 0 6 1 3 1 3 0 1” and the response will be “1 2 0 0 5 1 3 2 22 17” which indicates the model is 2217.

The screenshot shows the MBTCP Ver. 1.1.5 interface. The 'Protocol Description' field is highlighted with a red box and contains the following text:

```

FC1 Read multiple coils status (0xxxx) for DO
[Prefixed 6 bytes for Modbus/TCP protocol]
Byte 0: Transaction identifier - copied by server - usually 0
Byte 1: Transaction identifier - copied by server - usually 0
Byte 2: Protocol identifier=0
Byte 3: Protocol identifier=0
Byte 4: Field Length (upper byte)=0
    
```

The command log shows the following sequence:

```

[Byte0] [Byte1] [Byte2] [Byte3] [Byte4] [Byte5]
1 2 0 0 6 1 3 1 3 0 1
    
```

The response log shows the following sequence:

```

[Byte0] [Byte1] [Byte2] [Byte3] [Byte4] [Byte5]
01 02 00 00 00 06 --> 01 03 01 03 00 01
[Byte0] [Byte1] [Byte2] [Byte3]
01 02 00 00 00 05 --> 01 03 02 22 17
    
```

Refer to the example in Section 6.2.3 and Section 6.2 Modbus Message Structure.

1. Command	Leading	Request
		01 02 00 00 00 06 01 03 01 03 00 01
2. Response	Leading	Response
		01 02 00 00 00 05 01 03 02 22 17

4. Web Configuration

The Ethernet I/O module has a built-in Web Server to provide an intuitive web management interface, allowing users to modify the module's settings by using a web browser.

4.1 Logging into the Web Server

After completing the network settings, users can access the module's built-in web server from any computer that's connected to the same network. Follow these steps:

Step1. Open a web browser

Open a standard web browser. For example, Mozilla Firefox, Google Chrome, Internet Explorer, and so on.



Note that if you intend to use Internet Explorer, ensure that the cache function is disabled to avoid browser access errors.

Step2. Enter the IP address of the module into the address bar

Ensure that you have correctly configured the network settings for the I/O module, or refer to [Section 3.3 "Configuring the Network Settings"](#).

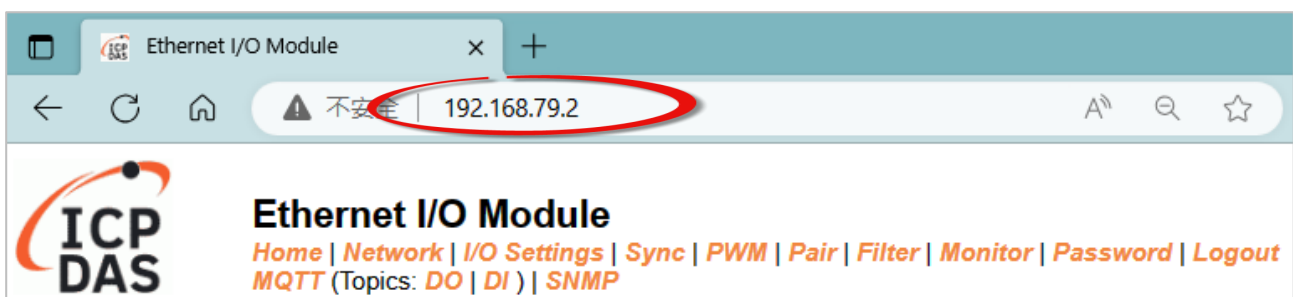

Note1: The function tab will be different depending on the I/O type of the module.

Note2: The "Sync" and "PWM" functions are only suitable for the DIO module.

Note3: The "SNMP" function is unavailable for ET-2217CI /2217CI-4 (AI) and ET-2224CI/2228CI (AO) modules.

Step3. Enter the password

For the first time to log into the web interface, the default password must be changed. Enter the factory preset password “Admin” and give a new password. Then, click the “Submit” button.

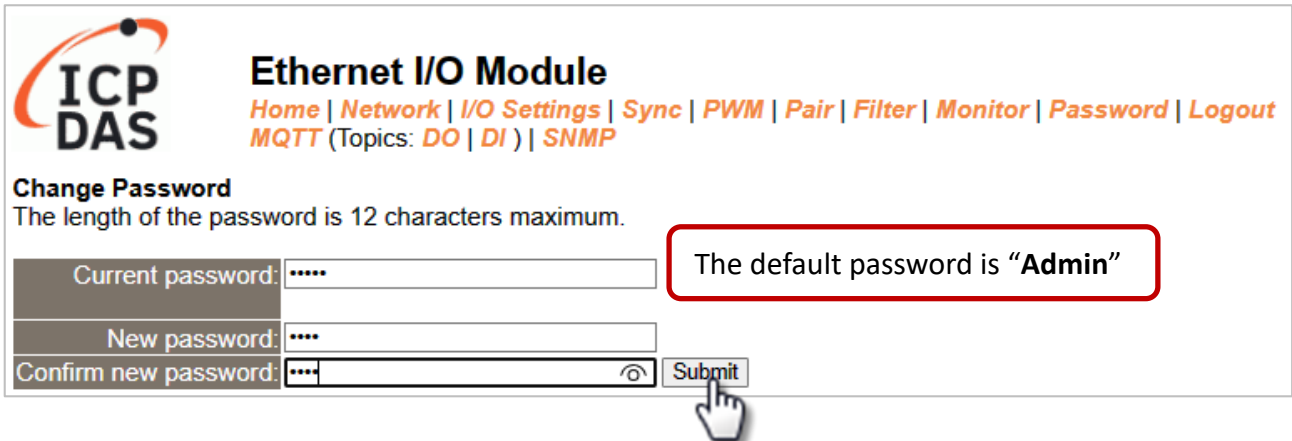

Enter the new password in the “Login password” field and click the “Submit” button to log into the web server. Also, refer the [Section 4.10 “Change Password”](#).

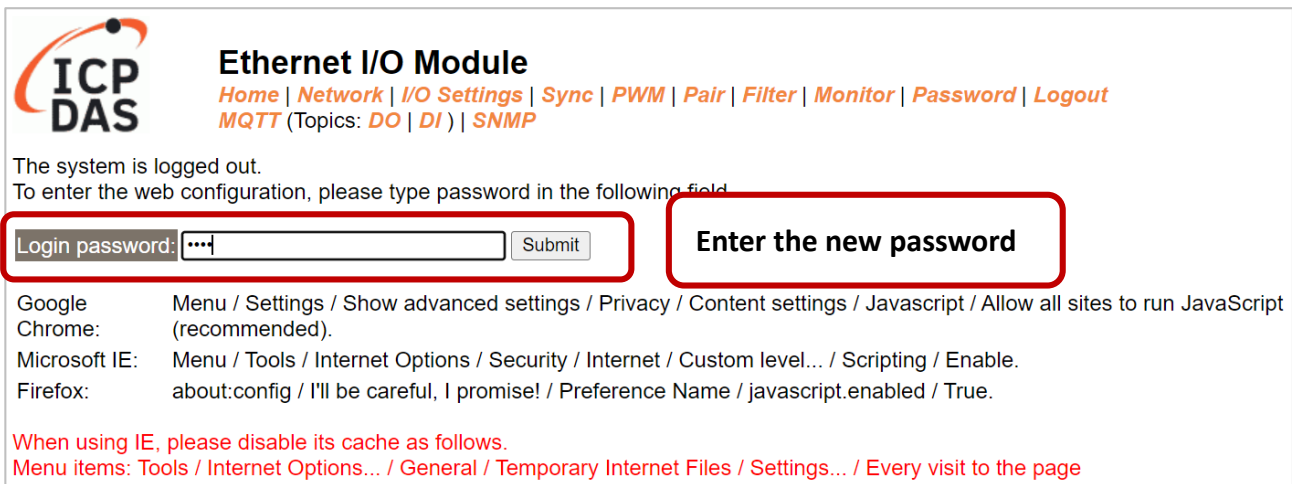

Step 4: Login to the web server

After logging into the module’s web server, the Home page will be displayed. The function tabs will be different depending on the I/O type of the module. Please refer to the following screens.

Analog Input, Analog Output

Ethernet I/O Module

[Home](#) | [Network](#) | [I/O Settings](#) | [MQTT](#) | [Pair](#) | [Filter](#) | [Monitor](#) | [Password](#) | [Logout](#)

Model Name	ET-2217CI	Alias Name	EtherIO
Firmware Version	v2.0.2 [Jan.28, 2021]	MAC Address	00-0D-E0-FF-FF-FF
IP Address	192.168.79.117	Initial Switch	OFF
TCP Port Timeout (Socket Watchdog, Seconds)	180	System Timeout (Network Watchdog, Seconds)	0

Analog Input Readings

Analog Input Channel	Range (40096)	Value (30000)	Low Latched (30544)	High Latched (30512)
AI0	08: +/-10 V	-00.085 fee8h	-00.086 fee5h	-00.085 feeah
AI1	08: +/-10 V	+00.013 002bh	+00.012 0027h	+00.013 002ch
AI2	08: +/-10 V	+00.024 0050h	+00.024 004eh	+00.025 0052h
AI3	08: +/-10 V	+00.038 007fh	+00.037 007ch	+00.039 0080h
AI4	08: +/-10 V	+00.002 0007h	+00.000 0001h	+00.002 0008h
AI5	08: +/-10 V	-00.005 fff0h	-00.005 fff0h	+00.000 fffeh
AI6	08: +/-10 V	+00.010 0021h	+00.000 0002h	+00.010 0022h
AI7	08: +/-10 V	+00.000 fffeh	+00.000 fffeh	+00.000 0000h

RTC

Date	2023-09-22	Time	11:55:13
------	------------	------	----------

Current Port Settings

Pair-Connection Settings	Port 1
Server Mode	Server
Remote Server IP	Disabled
Remote TCP Port	Disabled

Note: The above Modbus addresses are all 0 based.

Digital Input, Digital Output

Ethernet I/O Module

[Home](#) | [Network](#) | [I/O Settings](#) | [Sync](#) | [PWM](#) | [Pair](#) | [Filter](#) | [Monitor](#) | [Password](#) | [Logout](#)

MQTT (Topics: [DO](#) | [DI](#)) | [SNMP](#)

Model Name	ET-2260	Alias Name	DIO
Firmware Version	v2.4.0 [Sep.06 2022]	MAC Address	00-0d-e0-65-e9-85
IP Address	192.168.79.60	Initial Switch	OFF
TCP Timeout (Socket Watchdog, Seconds)	180	System Timeout (Network Watchdog, Seconds)	0

Digital I/O (Modbus Address: DO=00000 to 00015, DI=10000 to 10015.)

	DO7	DO6	DO5	DO4	DO3	DO2	DO1	DO0
DI Channel	Value (10000)		Counter (30016) / Frequency (30064)		High Latched (10032)		Low Latched (10064)	
D10	●		-		-		-	
D11	●		-		-		-	
D12	●		-		-		-	
D13	●		-		-		-	

4.2 Home

The **Home** page provides users with information about the I/O module, as detailed below.

4.2.1 Home – DI/DO

The first section offers information about the module, including the model, alias, firmware version, MAC address, the module's IP address, the operating mode switch (Init = OFF), and Watchdog timeouts.

Note: After updating the firmware, the user can check the version number on this page.

Ethernet I/O Module		Ethernet I/O Module	
Model Name	ET-2260	Alias Name	EtherIO
Firmware Version	v2.4.0 [Sep.06 2022]	MAC Address	00-0d-e0-65-e9-85
IP Address	192.168.79.2	Initial Switch	OFF
TCP Timeout (Socket Watchdog, Seconds)	180	System Timeout (Network Watchdog, Seconds)	0

The second section - Digital I/O provides information related to the current DIO status and DO control. **Note:** The user can click on the DO image to change the output status.

Digital I/O (Modbus Address: DO=00000 to 00015, DI=10000 to 10015.)

DI Channel	Value (10000)	Counter (30016) / Frequency (30064)	High Latched (10032)	Low Latched (10064)
DI0:	●	-	-	-
DI1:	●	-	-	-
DI2:	●	-	-	-
DI3:	●	-	-	-
DI4:	●	-	-	-
DI5:	●	-	-	-
DI6:	●	-	-	-
DI7:	●	-	-	-

Note: Above Modbus addresses are all 0 based.

4.2.2 Home – AI

This page will display different items depending on the model:

The first section offers information about the module, including the model, alias, firmware version, MAC address, the module's IP address, the operating mode switch (Init = OFF), and Watchdog timeouts.

Model Name	ET-2217CI	Alias Name	EtherIO
Firmware Version	v2.0.2 [Jan.28, 2021]	MAC Address	00-0D-E0-FF-FF-FF
IP Address	192.168.255.1	Initial Switch	OFF
TCP Port Timeout (Socket Watchdog, Seconds)	180	System Timeout (Network Watchdog, Seconds)	0

The second section - **Analog Input Readings**, provides information related to the AI data range, values, and latched values. In addition, the **Current Port Setting** can display information about the Pair-Connection function.

AI Channel	Value (30000~)	Type (40427~)	Channel Enable (00595~)	Hi Alarm Status/Clear (10224~)	Low Alarm Status/Clear (10256~)	Max Latch (30236~)	Min Latch (30268~)	Clear Latch (00764/796~)
AI0:	0.001	0x08:-10 ~ +10V	Enabled	Disable	Disable	0.001	-0.002	Clear Latch
AI1:	0.000	0x08:-10 ~ +10V	Enabled	Disable	Disable	0.001	-0.002	Clear Latch
AI2:	4.000	0x07:+4 ~ +20mA	Disabled	Disable	Disable	4.000	20.000	Clear Latch
AI3:	4.000	0x07:+4 ~ +20mA	Disabled	Disable	Disable	4.000	20.000	Clear Latch
AI4:	4.000	0x07:+4 ~ +20mA	Disabled	Disable	Disable	4.000	20.000	Clear Latch
AI5:	4.000	0x07:+4 ~ +20mA	Disabled	Disable	Disable	4.000	20.000	Clear Latch
AI6:	4.000	0x07:+4 ~ +20mA	Disabled	Disable	Disable	4.000	20.000	Clear Latch
AI7:	4.000	0x07:+4 ~ +20mA	Disabled	Disable	Disable	4.000	20.000	Clear Latch

Note: Above Modbus addresses are all 0 based.

Model Name	PI/ET-2215H-16	Alias Name	EtherIO
Firmware Version	v3.0.4 [Mar.05 2024]	MAC Address	00-0d-e0-ff-ff-ff
IP Address	192.168.79.1	Initial Switch	OFF
TCP Port Timeout (Socket Watchdog, Seconds)	180	System Timeout (Network Watchdog, Seconds)	0

Analog Input Readings

Analog Input Channel	Range (40212)	Value (30000)	Low Latched (30544)	High Latched (30512)
AI0	86: Pt100, 0.00385, -100 ~ 300 °C	+023.91	-023.91	+034.63
AI1	86: Pt100, 0.00385, -100 ~ 300 °C	-9999.9	-9999.9	-9999.9
AI2	86: Pt100, 0.00385, -100 ~ 300 °C	-9999.9	-9999.9	-9999.9

The value of -9999.9 indicates open wiring.

4.2.3 Home – AO

The first section offers information about the module, including the model, alias, firmware version, MAC address, the module's IP address, the operating mode switch (Init = OFF), and Watchdog timeouts.



Ethernet I/O Module

[Home](#) | [Network](#) | [I/O Settings](#) | [MQTT](#) | [SNMP](#) | [Pair](#) | [Filter](#) | [Monitor](#) | [Password](#) | [Logout](#)

Model Name	P/ET-2228CIS	Alias Name	28CIS
Firmware Version	v01.2.0 [20240605]	MAC Address	00-0d-e0-ff-ff-ff
IP Address	192.168.79.28	Initial Switch	ON[F]
TCP Timeout (Socket Watchdog, Seconds)	0	System Timeout (Network Watchdog, Seconds)	0
Modbus Format	Hexadecimal	Host Timeout (Safe Value, Seconds)	0

The second section - Analog Output, provides information related to the AO data type, read value, open wire detection, power-on value, safe value, and slew rate. Also, the AO value can be set.

Note: The OVP (Over-value Protection) settings are available for (P)ET-224CIS/(P)ET-2228CIS.

Analog Output (Modbus Address: AO=40000 to 40007.)

AO Channel	Type (40459~466)	AO Read (40000~007)	AO Write (40000~007)	Submit Value	OVP Read Back (30000~007)	Wire Break (10290~297)
AO0:	0x32:0 ~ +10V	0.000	<input type="text" value="0.000"/>	<input type="button" value="Set Value"/>	0.00	-
AO1:	0x32:0 ~ +10V	0.000	<input type="text" value="0.000"/>	<input type="button" value="Set Value"/>	0.00	-
AO2:	0x32:0 ~ +10V	0.000	<input type="text" value="0.000"/>	<input type="button" value="Set Value"/>	0.00	-
AO3:	0x32:0 ~ +10V	0.000	<input type="text" value="0.000"/>	<input type="button" value="Set Value"/>	0.00	-
AO4:	0x32:0 ~ +10V	0.000	<input type="text" value="0.000"/>	<input type="button" value="Set Value"/>	0.00	-
AO5:	0x32:0 ~ +10V	0.000	<input type="text" value="0.000"/>	<input type="button" value="Set Value"/>	0.00	-
AO6:	0x32:0 ~ +10V	0.000	<input type="text" value="0.000"/>	<input type="button" value="Set Value"/>	0.00	-
AO7:	0x32:0 ~ +10V	0.000	<input type="text" value="0.000"/>	<input type="button" value="Set Value"/>	0.00	-

AO Channel	Power On Value (40360~367)	Safe Value (40392~399)	Slew Rate (40523~530)	OVP Alarm Status/Clear	OVP Alarm Value	OVP Alarm Enable
AO0:	0.000	0.000	0x00:Immediate	<input type="text" value="-"/>	0.00	Disable
AO1:	0.000	0.000	0x00:Immediate	<input type="text" value="-"/>	0.00	Disable
AO2:	0.000	0.000	0x00:Immediate	<input type="text" value="-"/>	0.00	Disable
AO3:	0.000	0.000	0x00:Immediate	<input type="text" value="-"/>	0.00	Disable
AO4:	0.000	0.000	0x00:Immediate	<input type="text" value="-"/>	0.00	Disable
AO5:	0.000	0.000	0x00:Immediate	<input type="text" value="-"/>	0.00	Disable
AO6:	0.000	0.000	0x00:Immediate	<input type="text" value="-"/>	0.00	Disable
AO7:	0.000	0.000	0x00:Immediate	<input type="text" value="-"/>	0.00	Disable

Current port settings:

Pair-Connection Settings	Port 1
Server Mode	Server
Remote Server IP	Disabled
Remote TCP Port	Disabled

Note: Above Modbus addresses are all 0 based.

4.2.4 OVP (Over-value Protection) Mechanism

The (P)ET-2224CIS/(P)ET-2228CIS provides the OVP (Over-value Protection) function. The module will stop outputting when a voltage or current exceeds the OVP alarm value. In addition, the “OVP” indicator on the module's front panel will light up.

Users can enable the OVP function on the “I/O Settings” page and set the “OVP Alarm Value”, then click the “Update Settings” button.

ICP DAS Ethernet I/O Module
[Home](#) | [Network](#) | [I/O Settings](#) | [MQTT](#) | [SNMP](#) | [Pair](#) | [Filter](#) | [Monitor](#) | [Password](#) | [Logout](#)

Analog Output Configuration

AO Channel	Type (40459~466)	Power On Value (40360~367)	Safe Value (40392~399)	Slew Rate (40523~530)	OVP Alarm Value (40580~587)	OVP Enable (00340~347)	Retained Enable (00769~776)
AO0:	0x32: 0 ~ +10V	0.000	0.000	0x00:Immediate	9.00	Enabled	Enabled
AO1:	0x32: 0 ~ +10V	0.000	0.000	0x00:Immediate	0.00	Disabled	Disabled
AO2:	0x32: 0 ~ +10V	0.000	0.000	0x00:Immediate	0.00	Disabled	Disabled
AO3:	0x32: 0 ~ +10V	0.000	0.000	0x00:Immediate	0.00	Disabled	Disabled
AO4:	0x32: 0 ~ +10V	0.000	0.000	0x00:Immediate	0.00	Disabled	Disabled
AO5:	0x32: 0 ~ +10V	0.000	0.000	0x00:Immediate	0.00	Disabled	Disabled
AO6:	0x32: 0 ~ +10V	0.000	0.000	0x00:Immediate	0.00	Disabled	Disabled
AO7:	0x32: 0 ~ +10V	0.000	0.000	0x00:Immediate	0.00	Disabled	Disabled

Modbus Format: Action: Modbus Read/Write Format Hexadecimal or Engineering

Host Timeout (Safe Value/Enable, Seconds): (5 ~ 65535 s, <5 = Default Disabled) Action:AO Output Safe Value

After completing the settings, the OVP status and the alarm value are displayed on the “Home” page.

ICP DAS Ethernet I/O Module
[Home](#) | [Network](#) | [I/O Settings](#) | [MQTT](#) | [SNMP](#) | [Pair](#) | [Filter](#) | [Monitor](#) | [Password](#) | [Logout](#)

Analog Output (Modbus Address: AO=40000 to 40007.)

AO Channel	Type (40459~466)	AO Read (40000~007)	AO Write (40000~007)	Submit Value	OVP Read Back (30000~007)	Wire Break (10290~297)
AO0:	0x32: 0 ~ +10V	0.000	<input type="text" value="0.000"/>	<input type="button" value="Set Value"/>	0.00	-
AO1:	0x32: 0 ~ +10V	0.000	<input type="text" value="0.000"/>	<input type="button" value="Set Value"/>	0.00	-
AO2:	0x32: 0 ~ +10V	0.000	<input type="text" value="0.000"/>	<input type="button" value="Set Value"/>	0.00	-
AO3:	0x32: 0 ~ +10V	0.000	<input type="text" value="0.000"/>	<input type="button" value="Set Value"/>	0.00	-
AO4:	0x32: 0 ~ +10V	0.000	<input type="text" value="0.000"/>	<input type="button" value="Set Value"/>	0.00	-
AO5:	0x32: 0 ~ +10V	0.000	<input type="text" value="0.000"/>	<input type="button" value="Set Value"/>	0.00	-
AO6:	0x32: 0 ~ +10V	0.000	<input type="text" value="0.000"/>	<input type="button" value="Set Value"/>	0.00	-
AO7:	0x32: 0 ~ +10V	0.000	<input type="text" value="0.000"/>	<input type="button" value="Set Value"/>	0.00	-

AO Channel	Power On Value (40360~367)	Safe Value (40392~399)	Slew Rate (40523~530)	OVP Alarm Status/Clear	OVP Alarm Value	OVP Alarm Enable
AO0:	0.000	0.000	0x00:Immediate	<input type="text" value="Normal"/>	9.00	<input type="text" value="Enable"/>
AO1:	0.000	0.000	0x00:Immediate	<input type="text" value="-"/>	0.00	<input type="text" value="Disable"/>
AO2:	0.000	0.000	0x00:Immediate	<input type="text" value="-"/>	0.00	<input type="text" value="Disable"/>

When the AO value is greater than or equal to the OVP alarm value, the screen will display the OVP readback value and the “Alarm” status.

ICP DAS Ethernet I/O Module
[Home](#) | [Network](#) | [I/O Settings](#) | [MQTT](#) | [SNMP](#) | [Pair](#) | [Filter](#) | [Monitor](#) | [Password](#) | [Logout](#)

Analog Output (Modbus Address: AO=40000 to 40007.)

AO Channel	Type (40459~466)	AO Read (40000~007)	AO Write (40000~007)	Submit Value	OVP Read Back (30000~007)	Wire Break (10290~297)
AO0:	0x32:0 ~ +10V	9.499	9.5	<input type="button" value="Set Value"/>	9.50	-
AO1:	0x32:0 ~ +10V	0.000	0.000	<input type="button" value="Set Value"/>	0.00	-
AO2:	0x32:0 ~ +10V	0.000	0.000	<input type="button" value="Set Value"/>	0.00	-
AO3:	0x32:0 ~ +10V	0.000	0.000	<input type="button" value="Set Value"/>	0.00	-
AO4:	0x32:0 ~ +10V	0.000	0.000	<input type="button" value="Set Value"/>	0.00	-
AO5:	0x32:0 ~ +10V	0.000	0.000	<input type="button" value="Set Value"/>	0.00	-
AO6:	0x32:0 ~ +10V	0.000	0.000	<input type="button" value="Set Value"/>	0.00	-
AO7:	0x32:0 ~ +10V	0.000	0.000	<input type="button" value="Set Value"/>	0.00	-

AO Channel	Power On Value (40360~367)	Safe Value (40392~399)	Slew Rate (40523~530)	OVP Alarm Status/Clear	OVP Alarm Value	OVP Alarm Enable
AO0:	0.000	0.000	0x00:Immediate	<input type="button" value="Alarm"/>	9.00	Enable
AO1:	0.000	0.000	0x00:Immediate	<input type="button" value="-"/>	0.00	Disable
AO2:	0.000	0.000	0x00:Immediate	<input type="button" value="-"/>	0.00	Disable
AO3:	0.000	0.000	0x00:Immediate	<input type="button" value="-"/>	0.00	Disable
AO4:	0.000	0.000	0x00:Immediate	<input type="button" value="-"/>	0.00	Disable
AO5:	0.000	0.000	0x00:Immediate	<input type="button" value="-"/>	0.00	Disable
AO6:	0.000	0.000	0x00:Immediate	<input type="button" value="-"/>	0.00	Disable
AO7:	0.000	0.000	0x00:Immediate	<input type="button" value="-"/>	0.00	Disable

If the AO value later falls below the OVP alarm value, the user can click the “Alarm” button to clear the “Alarm” status.

Analog Output (Modbus Address: AO=40000 to 40007.)

AO Channel	Type (40459~466)	AO Read (40000~007)	AO Write (40000~007)	Submit Value	OVP Read Back (30000~007)	Wire Break (10290~297)
AO0:	0x32:0 ~ +10V	5.001	5	<input type="button" value="Set Value"/>	5.00	-
AO1:	0x32:0 ~ +10V	0.000	0.000	<input type="button" value="Set Value"/>	0.00	-
AO2:	0x32:0 ~ +10V	0.000	0.000	<input type="button" value="Set Value"/>	0.00	-
AO3:	0x32:0 ~ +10V	0.000	0.000	<input type="button" value="Set Value"/>	0.00	-
AO4:	0x32:0 ~ +10V	0.000	0.000	<input type="button" value="Set Value"/>	0.00	-
AO5:	0x32:0 ~ +10V	0.000	0.000	<input type="button" value="Set Value"/>	0.00	-
AO6:	0x32:0 ~ +10V	0.000	0.000	<input type="button" value="Set Value"/>	0.00	-
AO7:	0x32:0 ~ +10V	0.000	0.000	<input type="button" value="Set Value"/>	0.00	-

AO Channel	Power On Value (40360~367)	Safe Value (40392~399)	Slew Rate (40523~530)	OVP Alarm Status/Clear	OVP Alarm Value	OVP Alarm Enable
AO0:	0.000	0.000	0x00:Immediate	<input type="button" value="Normal"/>	9.00	Enable
AO1:	0.000	0.000	0x00:Immediate	<input type="button" value="-"/>	0.00	Disable
AO2:	0.000	0.000	0x00:Immediate	<input type="button" value="-"/>	0.00	Disable
AO3:	0.000	0.000	0x00:Immediate	<input type="button" value="-"/>	0.00	Disable
AO4:	0.000	0.000	0x00:Immediate	<input type="button" value="-"/>	0.00	Disable
AO5:	0.000	0.000	0x00:Immediate	<input type="button" value="-"/>	0.00	Disable
AO6:	0.000	0.000	0x00:Immediate	<input type="button" value="-"/>	0.00	Disable
AO7:	0.000	0.000	0x00:Immediate	<input type="button" value="-"/>	0.00	Disable

4.3 Network

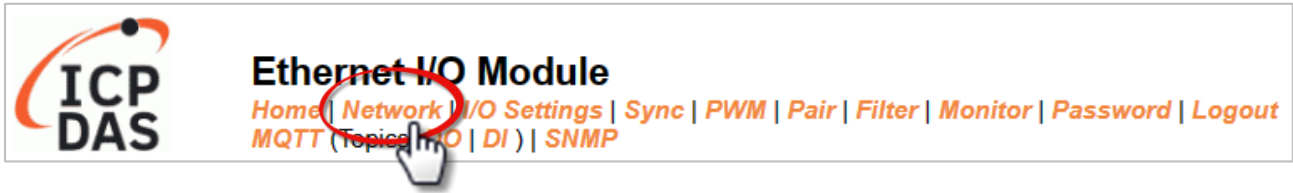

The **Network** page provides four sections, each of which will be described in more detail below.

1. IP Address:

It can be used to configure the Ethernet settings for ET-2200, e.g., the IPv4 address, the IPv6 address, DNS settings, and Modbus TCP Slave settings.

2. General Settings:

It can be used to configure the Ethernet speed, system timeout, TCP timeout, UDP heartbeat settings, and web auto-logout for ET-2200.

3. Other Operations:

It can be used to reset the ET-2200 to factory defaults or reboot, or remotely upgrade its firmware.

4.3.1 IP Address Configuration

IP Address

IPv4 Address	
Address Type	Static IP <input type="button" value="v"/>
Static IPv4 Address	<input type="text" value="192"/> . <input type="text" value="168"/> . <input type="text" value="255"/> . <input type="text" value="2"/>
Subnet Mask	<input type="text" value="255"/> . <input type="text" value="255"/> . <input type="text" value="0"/> . <input type="text" value="0"/>
Default Gateway	<input type="text" value="192"/> . <input type="text" value="168"/> . <input type="text" value="0"/> . <input type="text" value="1"/>
MAC Address	<input type="text" value="00-0d-e0-ff-ff-33"/> (Format: FF-FF-FF-FF-FF-FF)
IPv6 Address	
Link Local Address	<input type="text" value="fe80:0:0:20d:e0ff:feff:f33"/>
SLAAC Address	<input type="text" value="0:0:0:0:0:0"/>
SLAAC Timeout (SLAAC Watchdog)	<input type="text" value="0"/> (30 ~ 65000 seconds, 0 = Default Disabled)
User-defined Address	<input type="text" value="fc00:0:0:0:0:0:1"/>
DNS Settings Client Mode Only	
Auto DNS Configuration	<input type="button" value="v"/> (Auto DNS Server Configuration by IPv4 DHCP. Default = Enable)
Preferred DNS Server IP	<input type="text" value="208.67.222.222"/> IPv4 example: 208.67.222.222, IPv6 example: 2620:119:35::35
Alternate DNS Server IP	<input type="text" value="208.67.220.220"/> IPv4 example: 208.67.220.220, IPv6 example: 2620:119:53::53
Modbus TCP Slave	
Local Modbus TCP port	<input type="text" value="502"/> (Default= 502)
Local Modbus NetID	<input type="text" value="1"/> (Default= 1)
Check Modbus NetID	<input type="button" value="v"/> (Process messages with correct NetID only. Default = Enable)
<input type="button" value="Update Settings"/>	

Note: The IPv6 Address and DNS settings are not supported for some models.

The table describes the parameters contained in the "IP Address Configuration" section.

Item	Description
IPv4 Address	
Address Type	Static IP: If there is no DHCP server installed in your network, you can configure the network settings manually. Refer to Section "Manual Configuration" for more details.
	DHCP: Dynamic Host Configuration Protocol (DHCP) is a network application protocol that automatically assigns an IP address to each device. Refer to the Section "Dynamic Configuration" for more details.
Static IPv4 Address	This parameter is used to assign a specific IP address. Each ET-2200 module connected to the network must have its unique IP address.
Subnet Mask	This parameter is used to assign the subnet mask for the ET-2200 module. The subnet mask indicates which portion of the IP address is used to identify the local network or subnet.
Default Gateway	This parameter is used to assign the IP Address of the Gateway to be used by the ET-2200 module. A Gateway (or router) is a device that is used to connect an individual network to one or more additional networks.
MAC Address	This parameter is used to set the User-defined MAC address, which must be in the format FF-FF-FF-FF-FF-FF.
IPv6 Address	
Link Local Address	Each IPv6 device connected to the network must have a link-local address. The address is auto-configured by (P)ET-2200 and is always effective in the same link layer.
SLAAC Address	The (P)ET-2200 supports stateless address auto-configuration (SLAAC), which is automatically configured by the router. The default router is the link-local address of the router.
SLAAC Timeout (SLAAC Watchdog)	This parameter is used to set the Timeout value of SLAAC. If the SLAAC address is not assigned within the specified time, the system will reboot and configure the SLAAC address again.
User-defined Address	This parameter is used to set the IP address of the module. Each (P)ET-2200 connected to the network must have a unique IP address.

DNS Settings	
Auto DNS Configuration	<p>Enable: The IP address of the DNS Server is automatically set by IPv4 DHCP.</p> <p>Disable: Automatically set to the preferred IP address of the DNS Server.</p>
Preferred DNS Server IP	This parameter is used to set the preferred IP address of the DNS Server.
Alternate DNS Server IP	This parameter is used to set the alternate IP address of the DNS Server.
Modbus TCP Slave	
Local Modbus TCP port	This parameter is used to set the local port to be used by the Modbus slave device. The default value is 502.
Local Modbus NetID	This parameter is used to set the Network ID to be used by the Modbus slave device. The default value is 1.
Update Settings	Click this button to save the changes.

Dynamic Configuration

If your network is connected to a DHCP server, you can simply configure a dynamic IP address as follows.

Step 1: Select “**DHCP**” from the Address Type drop-down menu.

Step 2: Click the “**Update Settings**” button to complete the configuration.

IPv4 Address	
Address Type	DHCP
Static IPv4 Address	192 . 168 . 79 . 2
Subnet Mask	255 . 255 . 0 . 0
Default Gateway	192 . 168 . 1 . 1
MAC Address	00-0d-e0-65-cf-d3 (Format: FF-FF-FF-FF-FF-FF)
Modbus TCP Slave	
Local Modbus TCP port	502 (Default= 502)
Local Modbus NetID	1 (Default= 1)
Check Modbus NetID	Enable (Process messages with correct NetID only. Default = Enable)
Update Settings	

Manual Configuration

Follow the steps below to manually configure the IP address.

Step 1: Select “**Static IP**” from the **Address Type** drop-down menu.

Step 2: Enter the network settings of the module.

(The user can modify the network settings in Section 3.3)

Step 3: Click the “**Update Settings**” button to complete the configuration.

IPv4 Address	
Address Type	Static IP
Static IPv4 Address	192 . 168 . 79 . 2
Subnet Mask	255 . 255 . 0 . 0
Default Gateway	192 . 168 . 1 . 1
MAC Address	00-0d-e0-65-cf-d3 (Format: FF-FF-FF-FF-FF-FF)
Modbus TCP Slave	
Local Modbus TCP port	502 (Default= 502)
Local Modbus NetID	1 (Default= 1)
Check Modbus NetID	Enable (Process messages with correct NetID only. Default = Enable)
Update Settings	

4.3.2 General Settings

General Settings

Ethernet Speed	Auto ▾ (Auto=10/100 Mbps Auto-negotiation)
System Timeout (Network Watchdog)	0 (30 ~ 65535 s, Default= 0, Disable= 0) Action:Reboot
TCP Timeout	180 (5 ~ 65535 s, Default= 180, Disable= 0) Action:Cut-off
UDP Configuration	Enable ▾ (Enable/Disable the UDP Configuration, Enable=default.)
Web Auto-logout	10 (1 ~ 65535 minutes, Default= 10, Disable= 0)
HTTP port	80 (Default= 80)
Alias Name	EtherIO (Max. 18 chars)
<input type="button" value="Update Settings"/>	

The table describes the parameters contained in the "**General Settings**" section.

Item	Description
Ethernet Speed	This parameter is used to set the Ethernet speed. The default value is Auto (Auto = 10/100 Mbps Auto-negotiation).
System Timeout (Network Watchdog)	This parameter is used to configure the system timeout value. If there is no activity on the network for a specific time, the system will be rebooted based on the configured system timeout value.
TCP Timeout (Seconds)	This parameter is used to configure the TCP timeout value. If Modbus TCP communication is idle for a specific time, the system will cut off the connection.
UDP Configuration	This parameter is used to enable or disable the UDP configuration function.
Web Auto-logout	This parameter is used to configure the automatic logout value. If there is no activity on the web server for a specific time, the current user account will automatically be logged out.
Alias Name	This parameter is used to assign an alias name for each ET-2200 module to assist with easy identification.
HTTP Port	This parameter is used to assign specific a HTTP port to the ET-2200 module. The ET-2200 needs to be restarted when the HTTP port is changed. You need manually type the new HTTP port in the address bar of the browser. The default is 80. For example, if the HTTP port is set to 81, then enter the "IP address: HTTP port" (10.0.8.123:81).
Update Settings	Click this button to save the changes.

4.3.3 Restore Factory Defaults/Firmware Update

Other Operations

Restore all options to their factory default states	Restore Defaults
Reboot the module	Reboot
Firmware update via Ethernet If the remote firmware update is failed, then on-site firmware update is required to make the module working again. Step 1: Refer to firmware update manual first. Step 2: Run eSearch Utility to prepare and wait for update. Step 3: Click the [Update] button to reboot the module and start update. Step 4: Configure the module again.	Update

Note: This setup page may be different for some modules, but the functions are the same.

➤ **Restore all options to their factory default states**

To reset all parameters to their original factory default settings, use the following procedure:

- Step 1:** Click the “Restore Defaults” button to factory reset the module.
- Step 2:** Click the “OK” button in the message dialog box.
- Step 3:** Check whether the module has been reset to the original factory default settings for use with the **eSearch Utility**. Refer to [Section 3.3 “Configuring the Network Settings”](#).

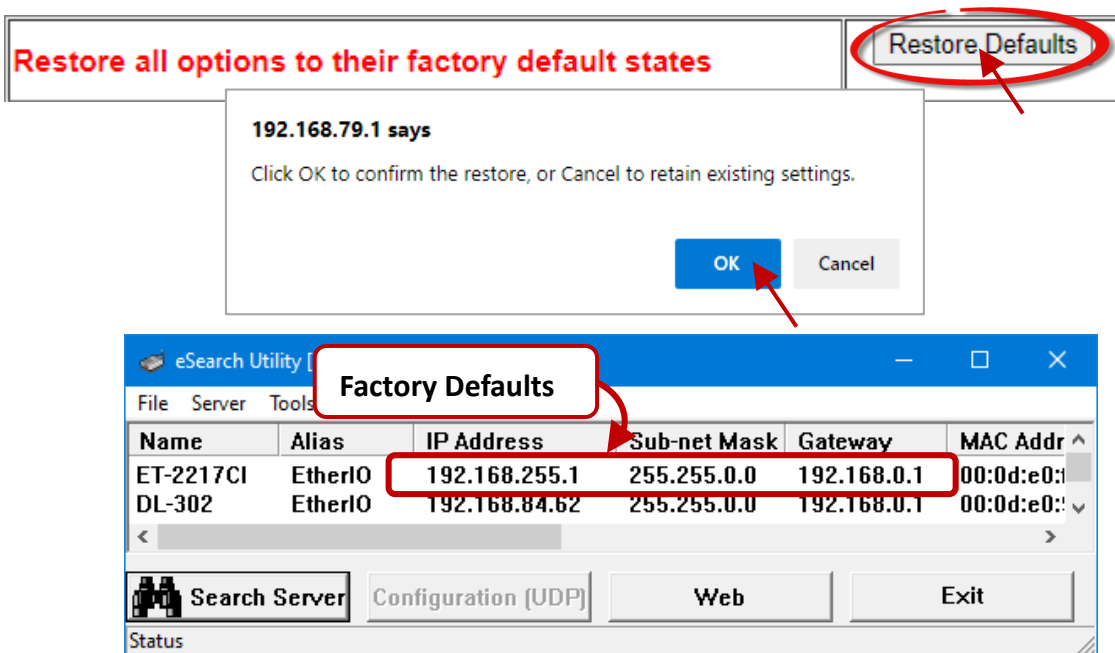

➤ **Reboot the module**

The **Reboot the module** function can be used to remotely force the ET-2200 module to reboot. After that, enter the password to log into the main page.

Other Operations

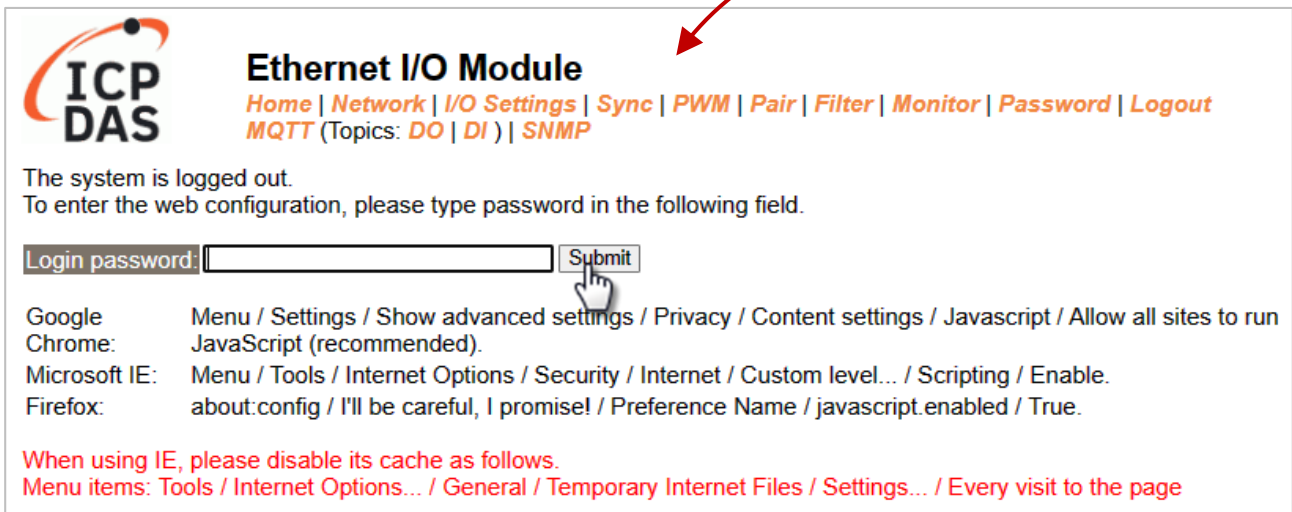

➤ **Firmware Update**

When updating the firmware, the module requires initialization on the LAN. In the case of earlier firmware updates, users had to manually set the operating switch to "Init" and reboot the module to complete the initialization. However, with the new firmware update, users can now initiate the initialization process by clicking the "**Update**" button on the module's web interface.

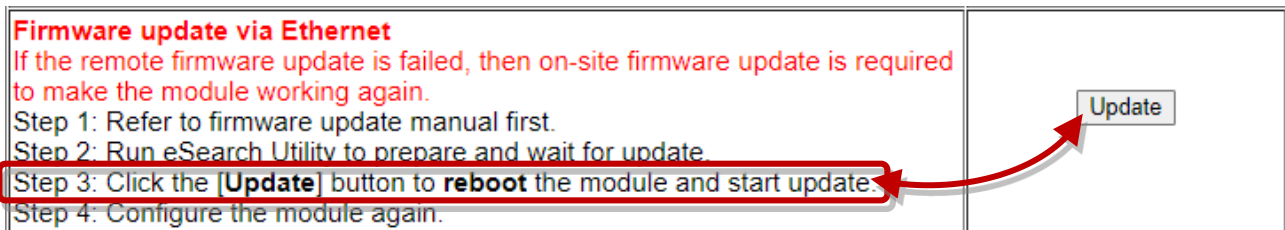

Visit the website to download the latest firmware of the ET-2200 module. Also, refer to the "ET-2200 Firmware Update Manual" for instructions.

<https://www.icpdas.com/en/download/show.php?num=2632>

When the module is installed remotely, you can also use remote control software (such as TeamViewer) to connect to the remote PC. This allows you to initialize the module and complete the firmware update through the web interface.

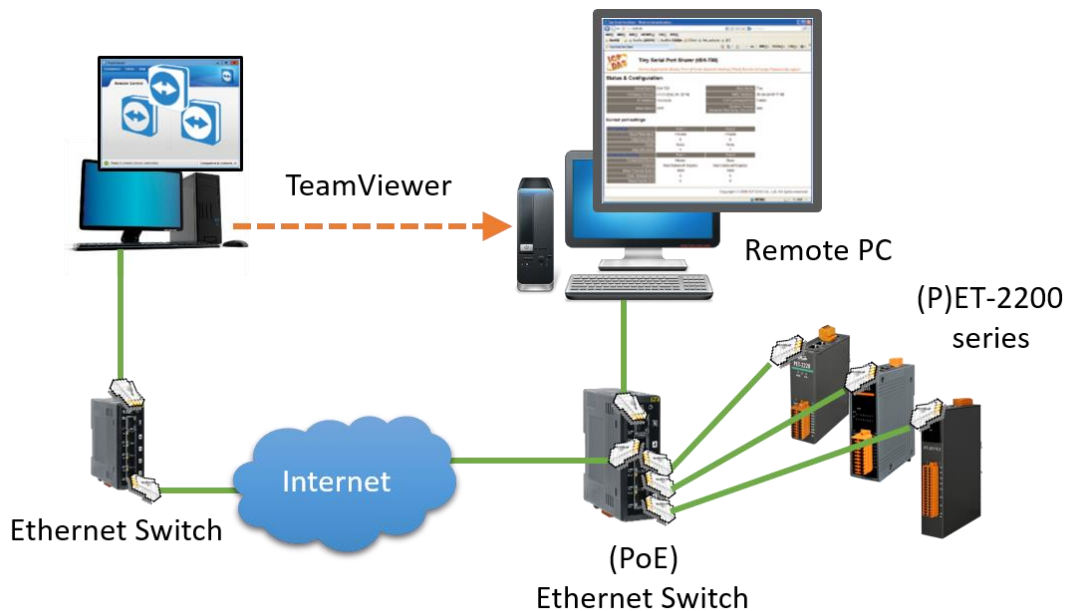

 **Note:**

If the **remote firmware update** fails, it may result in the module not functioning properly. In such cases, execute the "Firmware Update" using the eSearch Utility and **manually** initiate the initialization. This should restore the module to its normal state.

4.4 I/O Settings

The **I/O Settings** page allows you to configure the Digital Input, Digital Output, and Analog Input parameters for the ET-2200 series module.

4.4.1 DO Control

ICP DAS Ethernet I/O Module
[Home](#) | [Network](#) | [I/O Settings](#) | [Sync](#) | [PWM](#) | [Pair](#) | [Filter](#) | [Monitor](#) | [Password](#) | [Logout](#)
 MQTT (Topics: [DO](#) | [DI](#) | [AI](#))

Digital Output	Modbus Address	Setting
Value	00007 - 00000	0x0 (CH 7 - 0: <input type="checkbox"/> <input type="checkbox"/> <input type="checkbox"/> <input type="checkbox"/> <input type="checkbox"/> <input type="checkbox"/> <input type="checkbox"/>)
<input type="button" value="Update Settings"/>		

The table describes the parameters contained in the "**DO Control**" section.

Item	Description
Set DO value	This parameter is used to manually assign a specific value for the DO.
Update Settings	Click this button to save the changes.

4.4.2 DI/DO Configuration

DI/DO Configuration:

Digital Output	Modbus Address	Setting
Host/Slave Watchdog Timeout	40257	<input type="text" value="0"/> (10 ~ 65000 Seconds, Default= 0, Disable= 0) Outputs DO with safe-value or <i>PWM</i> when host/slave timeout.
Enable Safe Value (Enable Watchdog)	00339 - 00332	<input type="text" value="0x0"/> (CH 7 - 0: <input type="checkbox"/> <input type="checkbox"/> <input type="checkbox"/> <input type="checkbox"/> . <input type="checkbox"/> <input type="checkbox"/> <input type="checkbox"/> <input type="checkbox"/>)
Safe Value	00274 - 00267	<input type="text" value="0x0"/> (CH 7 - 0: <input type="checkbox"/> <input type="checkbox"/> <input type="checkbox"/> <input type="checkbox"/> . <input type="checkbox"/> <input type="checkbox"/> <input type="checkbox"/> <input type="checkbox"/>)
Power-On Value	00242 - 00235	<input type="text" value="0x0"/> (CH 7 - 0: <input type="checkbox"/> <input type="checkbox"/> <input type="checkbox"/> <input type="checkbox"/> . <input type="checkbox"/> <input type="checkbox"/> <input type="checkbox"/> <input type="checkbox"/>)
Digital Input	Modbus Address	Setting
Enable Latched DI	00150	<input type="checkbox"/> (Enable All = Checked)
Clear Latched Status (High)	00032	<input type="checkbox"/> (Clear High = Checked)
Clear Latched Status (Low)	00033	<input type="checkbox"/> (Clear Low = Checked)
DI Filter Level	40201	<input type="text" value="0"/> (1 ~ 6000 ms, Default= 0, Disable= 0)
Digital Counter	Modbus Address	Setting (Based on DI)
Enable Digital Counter	00158 - 00151	<input type="text" value="0x0"/> (CH 7 - 0: <input type="checkbox"/> <input type="checkbox"/> <input type="checkbox"/> <input type="checkbox"/> . <input type="checkbox"/> <input type="checkbox"/> <input type="checkbox"/> <input type="checkbox"/>)
Clear Digital Counter	00041 - 00034	<input type="text" value="0x0"/> (CH7 - 0: <input type="checkbox"/> <input type="checkbox"/> <input type="checkbox"/> <input type="checkbox"/> . <input type="checkbox"/> <input type="checkbox"/> <input type="checkbox"/> <input type="checkbox"/>)
Preset Counter Value	40065 - 40050	Ch 07: <input type="text" value="0"/> Ch 06: <input type="text" value="0"/> Ch 05: <input type="text" value="0"/> Ch 04: <input type="text" value="0"/> Ch 03: <input type="text" value="0"/> Ch 02: <input type="text" value="0"/> Ch 01: <input type="text" value="0"/> Ch 00: <input type="text" value="0"/>
Frequency Measurement	Modbus Address	Setting (Based on DI)
Enable Frequency Measurement	00197 - 00190	<input type="text" value="0x0"/> (CH 7 - 0: <input type="checkbox"/> <input type="checkbox"/> <input type="checkbox"/> <input type="checkbox"/> . <input type="checkbox"/> <input type="checkbox"/> <input type="checkbox"/> <input type="checkbox"/>)
Scan Mode	40150	Single pulse ▼ 1000 ms: 1 Hz ~ 3 kHz (+/- 1 Hz error). 100 ms: 100 Hz to 3 kHz (+/- 10 Hz error). Single-pulse: 0.01 Hz ~ 1 Hz (+/- 0.01 Hz error), for stable signal only. Note: ET-2254P supports counter/frequency up-to 2.5 kHz.
Moving Average	40200	1 ▼
Universal DIO	Modbus Address	Setting (for ET-2254/P Only)
Configuration Mode	00299	Dynamic ▼ Static: By "Force DI/DO Mode" configuration. Dynamic: Depends on DO requests.
Force DI/DO Mode	00307 - 00300	<input type="text" value="0x0"/> (CH 7 - 0: <input type="checkbox"/> <input type="checkbox"/> <input type="checkbox"/> <input type="checkbox"/> . <input type="checkbox"/> <input type="checkbox"/> <input type="checkbox"/> <input type="checkbox"/>) 0=DO, 1=DI
<input type="button" value="Update Settings"/>		

The table describes the parameters contained in the "DI/DO Configuration" section.

Item	Description
Digital Output	
Host/Slave Watchdog Timeout	This parameter is used to configure the Host Watchdog timeout value. If there is no Modbus TCP communication activity for the specified period (the timeout), then the Host Watchdog will activate an alarm.
Enable Safe Value (Enable Watchdog)	This parameter is used to enable the watchdog on each DO channel.

Item	Description
Safe Value	This parameter is used to define the DO safe value for the ET-2200 module. If the Host Watchdog alarm is activated, the DO will be set to the user-defined safe value.
Power-On Value	This parameter is used to define the DO Power-on value. On boot-up, the DO is set to the user-defined Power-on value.
Digital Input	
Enable Latched DI	This parameter is used to enable the latch function on all DI channels. The status of the DI will be recorded if it has been flagged as either high or low. 0 = Disable All; 1 = Enable All
Clear Latched Status (High)	This parameter is used to clear the status of all high-latched D/I. 0 = No Operation; 1 = Clear All
Clear Latched Status (Low)	This parameter is used to clear the status of all low-latched D/I. 0 = No Operation; 1 = Clear All
DI Filter Level	The DI filter eliminates high-frequency noise from the input and can be adjusted in a range of 1 to 6500 (ms). Refer to Appendix A.4 “What is Digital-Input Filter (DI Filter)” for more details.
Digital Counter	
Enable Digital Counter	This parameter is used to enable the digital counter on each DI channel.
Clear Digital Counter	This parameter is used to clear the values of each DI counter.
Preset Counter Value	This parameter is used to set the default value for each DI counter.
Frequency Measurement (DI)	
Enable Frequency Measurement	This parameter is used to enable the frequency measurement function on each DI channel.

Item	Description
Scan Mode	<p>This parameter is used to define the scan mode for the frequency measurement.</p> <p>1000 ms: This mode provides a normal update rate and normal accuracy. The acceptable frequency range for the input signal is 1 Hz to 3 kHz (± 1 Hz error). This mode can be used when the pulse width (signal source) contains small errors since the measurement is based on the pulse count.</p> <p>100 ms: This mode provides a fast update rate, but the accuracy is low. The acceptable frequency range for the input signal is 100 Hz to 3 kHz (± 10 Hz error). This mode can be used when the pulse width (signal source) contains small errors since the measurement is based on the pulse count.</p> <p>Single-pulse: This mode provides the highest accuracy but can only be used for a stable signal. The data update rate depends on the signal frequency and the acceptable signal frequency range for the input signal is 0.01 Hz to 3.5 kHz (± 0.01 Hz error). This mode can only be used when the pulse width (signal source) is stable since the measurement is based on the width of a single pulse.</p>
Moving Average	<p>1 ==> No Average is used 2 ==> Uses the average of 2 continuous sample values 4 ==> Uses the average of 4 continuous sample values 8 ==> Uses the average of 8 continuous sample values</p>
Universal DIO	
Force DI/DO Mode For ET-2254(P) only	<p>Dynamic: Dynamic I/O type based on DO requests.</p> <p>Static: Static I/O type by configuration (web or Modbus).</p> <div style="border: 1px solid black; padding: 5px; width: fit-content;"> 0x0 (CH 7 - 0: <input type="checkbox"/> <input type="checkbox"/> <input type="checkbox"/> <input type="checkbox"/> <input type="checkbox"/> <input type="checkbox"/> <input type="checkbox"/> <input type="checkbox"/>) 0=DO, 1=DI </div> <p>This parameter is used to set the Universal DIO channels to DI or DO Port. 1 ==> DI; 0 ==> DO</p>
Update Settings	Click this button to save the changes.

4.4.3 Analog Input Configuration

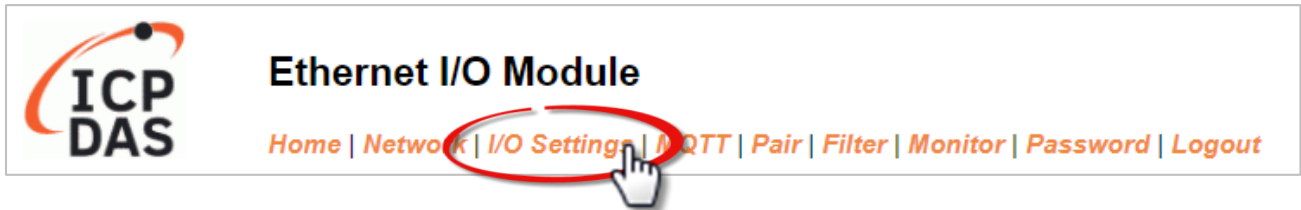

(A) Voltage/Current Input

AI Channel	Type (40427~434)	Channel Enable (00595~602)	Hi Alarm Enable (00636~643)	Hi Alarm Mode (00700~707)	Hi Alarm Value (40296~303)	Low Alarm Enable (00668~675)	Low Alarm Mode (00732~739)	Low Alarm Value (40328~335)
AI0:	0x07:4~20mA	Disabled	Disabled	Momentary	0.000	Disabled	Momentary	0.000
AI1:	0x07:4~20mA	Disabled	Disabled	Momentary	0.000	Disabled	Momentary	0.000
AI2:	0x07:4~20mA	Disabled	Disabled	Momentary	0.000	Disabled	Momentary	0.000
AI3:	0x07:4~20mA	Disabled	Disabled	Momentary	0.000	Disabled	Momentary	0.000
AI4:	0x07:4~20mA	Disabled	Disabled	Momentary	0.000	Disabled	Momentary	0.000
AI5:	0x07:4~20mA	Disabled	Disabled	Momentary	0.000	Disabled	Momentary	0.000
AI6:	0x07:4~20mA	Disabled	Disabled	Momentary	0.000	Disabled	Momentary	0.000
AI7:	0x07:4~20mA	Disabled	Disabled	Momentary	0.000	Disabled	Momentary	0.000
Modbus Format	Hexadecimal	Action: Modbus Read/Write Format Hexadecimal or Engineering						
Sampling Rate	Normal	Action: AI Sampling Rate setting						
Analog Input Mode	Differential	Action: Analog Input Mode Differential or Single End						
Update Settings								

some of the modules support the alarm function.

The table describes the parameters contained in the "Analog Input Configuration" section.

Item	Description
Analog Input Channel	
AI0 ~ AI7	Set the data range for each channel and whether to enable or disable it. If the alarm is enabled and the alarm mode is set to "Momentary" which means the alarm status will automatically be cleared if the alarm occurred and the AI value is back to normal. If the mode is set to "Latch", the alarm status can only be cleared by using the Clear command.
Analog Input	
Data Format	Set the data format, e.g., Hex or Engineering.
Sampling Rates	Set the sampling rate, Fast or Normal mode.
Analog Input Mode	Set the wiring mode, e.g., Differential or Single End.
Update Settings	Click this button to save the changes.

(B) RTD Input

The screenshot shows the ICP DAS Ethernet I/O Module web interface. The 'I/O Settings' menu item is highlighted with a red circle and a mouse cursor. Below the navigation bar, the 'Analog Input Configuration' section is visible, containing a table with the following structure:

Analog Input		Settings		
Sampling Rates (00141)	Fast <input type="button" value="v"/>			
Moving Average (40497)	1 <input type="text"/> (1 ~ 128, Default = 1)			
Analog Input Channel	Range (40212) <input type="checkbox"/> All as AI0	Temperature Offset (40288)	Resistance Offset (40384)	
AI0	86 Pt100, $\alpha=0.00385$, -100 ~ 300°C <input type="button" value="v"/>	0.00 <input type="text"/>	0.00 <input type="text"/>	
AI1	86 Pt100, $\alpha=0.00385$, -100 ~ 300°C <input type="button" value="v"/>	0.00 <input type="text"/>	0.00 <input type="text"/>	
AI2	86 Pt100, $\alpha=0.00385$, -100 ~ 300°C <input type="button" value="v"/>	0.00 <input type="text"/>	0.00 <input type="text"/>	
AI3	86 Pt100, $\alpha=0.00385$, -100 ~ 300°C <input type="button" value="v"/>	0.00 <input type="text"/>	0.00 <input type="text"/>	
AI4	86 Pt100, $\alpha=0.00385$, -100 ~ 300°C <input type="button" value="v"/>	0.00 <input type="text"/>	0.00 <input type="text"/>	
AI5	86 Pt100, $\alpha=0.00385$, -100 ~ 300°C <input type="button" value="v"/>	0.00 <input type="text"/>	0.00 <input type="text"/>	
AI6	86 Pt100, $\alpha=0.00385$, -100 ~ 300°C <input type="button" value="v"/>	0.00 <input type="text"/>	0.00 <input type="text"/>	
AI7	86 Pt100, $\alpha=0.00385$, -100 ~ 300°C <input type="button" value="v"/>	0.00 <input type="text"/>	0.00 <input type="text"/>	
AI8	86 Pt100, $\alpha=0.00385$, -100 ~ 300°C <input type="button" value="v"/>	0.00 <input type="text"/>	0.00 <input type="text"/>	
AI9	86 Pt100, $\alpha=0.00385$, -100 ~ 300°C <input type="button" value="v"/>	0.00 <input type="text"/>	0.00 <input type="text"/>	
AI10	86 Pt100, $\alpha=0.00385$, -100 ~ 300°C <input type="button" value="v"/>	0.00 <input type="text"/>	0.00 <input type="text"/>	
AI11	86 Pt100, $\alpha=0.00385$, -100 ~ 300°C <input type="button" value="v"/>	0.00 <input type="text"/>	0.00 <input type="text"/>	
AI12	86 Pt100, $\alpha=0.00385$, -100 ~ 300°C <input type="button" value="v"/>	0.00 <input type="text"/>	0.00 <input type="text"/>	
AI13	86 Pt100, $\alpha=0.00385$, -100 ~ 300°C <input type="button" value="v"/>	0.00 <input type="text"/>	0.00 <input type="text"/>	
AI14	86 Pt100, $\alpha=0.00385$, -100 ~ 300°C <input type="button" value="v"/>	0.00 <input type="text"/>	0.00 <input type="text"/>	
AI15	86 Pt100, $\alpha=0.00385$, -100 ~ 300°C <input type="button" value="v"/>	0.00 <input type="text"/>	0.00 <input type="text"/>	
<input type="button" value="Update Settings"/>				

Note: Above Modbus addresses are all 0 based.

The table describes the parameters contained in the **Analog Input Configuration** section.

Item	Description
Analog Input	
Sampling Rates	Set the sampling rate, Fast or Normal mode.
Moving Average	Set the moving average value of temperature.
Analog Input Channel	
AI0 ~ AI15	Set the temperature range, temperature offset, and resistance offset for each channel.
Update Settings	Click this button to save the changes.

(C) Thermocouple Input

Analog Input Configuration:

Analog Input		Settings		
Sampling Rates (00141)	Fast			
Moving Average (40497)	1	(1 ~ 128, Default = 1)		
CJC, Cold Junction Compensation (00267)	Enable			
Module CJC Offset (40490)	0.0			
Analog Input Channel	Range (40212) <input type="checkbox"/> All as AI0	Temperature Offset (40288)	Channel CJC Offset (40384)	
AI0	0F Type K Thermocouple, -270 ~ 1372°C	0.0	0.0	
AI1	0F Type K Thermocouple, -270 ~ 1372°C	0.0	0.0	
AI2	0F Type K Thermocouple, -270 ~ 1372°C	0.0	0.0	
AI3	0F Type K Thermocouple, -270 ~ 1372°C	0.0	0.0	
AI4	0F Type K Thermocouple, -270 ~ 1372°C	0.0	0.0	
AI5	0F Type K Thermocouple, -270 ~ 1372°C	0.0	0.0	
AI6	0F Type K Thermocouple, -270 ~ 1372°C	0.0	0.0	
AI7	0F Type K Thermocouple, -270 ~ 1372°C	0.0	0.0	
AI8	0F Type K Thermocouple, -270 ~ 1372°C	0.0	0.0	
AI9	0F Type K Thermocouple, -270 ~ 1372°C	0.0	0.0	
AI10	0F Type K Thermocouple, -270 ~ 1372°C	0.0	0.0	
AI11	0F Type K Thermocouple, -270 ~ 1372°C	0.0	0.0	
AI12	0F Type K Thermocouple, -270 ~ 1372°C	0.0	0.0	
AI13	0F Type K Thermocouple, -270 ~ 1372°C	0.0	0.0	
AI14	0F Type K Thermocouple, -270 ~ 1372°C	0.0	0.0	
AI15	0F Type K Thermocouple, -270 ~ 1372°C	0.0	0.0	
<input type="button" value="Update Settings"/>				

Note: Above Modbus addresses are all 0 based.

The table describes the parameters contained in the **Analog Input Configuration** section.

Item	Description
Analog Input	
Sampling Rates	Set the sampling rate, Fast or Normal mode.
Moving Average	Set the moving average value of temperature.
CJC, Cold Junction Compensation	Enable/Disable the cold junction compensation. (Accuracy is 0.1°C)
Module CJC Offset	Set the CJC offset of the module. (Accuracy is 0.1°C)
Analog Input Channel	
AI0 ~ AI15	Set the temperature range, temperature offset, and CJC offset for each channel.
Update Settings	Click this button to save the changes.

4.4.4 AI - Calibration

(A) Voltage/Current Input

Calibration

Now Mode		Change Mode	
Run		Calibration Mode	
Channel	Item	Set Calibration	
0 ▾	Zero ▾	Calibration Apply	

Warning: Incorrect manual calibration will cause your device's input imprecise.

1. Use "Calibration Mode" button to enter Calibration mode.
2. Select which Channel & Type going to manual calibration, then press "Update Settings" on top.
3. Apply the full scale source to the channel's Type(0x08,0x09,0x05,0x0A,0x0B,0x1A).
4. DMM(Digit Multimeter) is needed to measure the input as close as the full scale value.
5. Press "Calibration Apply" will calculate & store the value.

Note: Use "Restore Defaults" on Network page, can recover your calibration value from factory default.

The following table provides parameter notes for the **Calibration** section:

Item	Description
Calibration	
Now Mode	Used to display the current mode
Change Mode	Click the Calibration Mode (or Run Mode) button to change the mode
Channel	Choose the AI channel for calibration
Item	Choose to use either zero calibration or span calibration
Set Calibration	Click the Calibration Apply button to perform calibration

Step1: In the **Analog Input Configuration** section of the **I/O Settings** page, enable the AI channel and select the **Type** and **Modbus Format**, then click the **Update Settings** button to save the changes.

Analog Input Configuration

AI Channel	Type (40427~434)	Channel Enable (00595~602)	Hi Alarm Enable (00636~643)	Hi Alarm Mode (00700~707)	Hi Alarm Value (40296~303)
AI0:	0x08:0~+10V ▾	Enabled ▾	Disabled ▾	Momentary ▾	0.000
AI1:	0x08:0~+10V ▾	Enabled ▾	Disabled ▾	Momentary ▾	0.000
Modbus Format	Engineering ▾	Action: Modbus Read/Write Format Hexadecimal or Engineering			
Sampling Rate	Normal ▾	Action: AI Sampling Rate setting			
					Update Settings

Step2: In the **Calibration** section of the **I/O Settings** page, click the **Calibration Mode** button to get into the calibration mode.

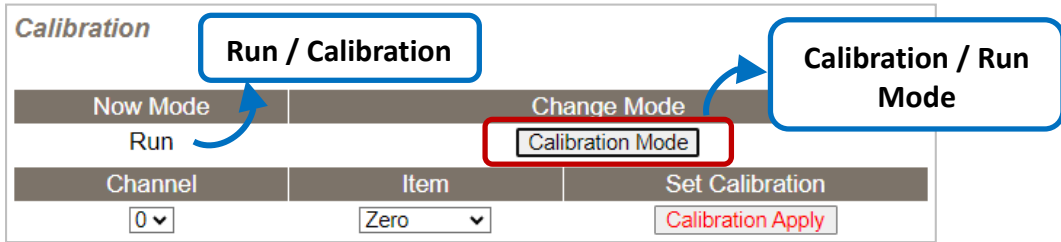

Step3: Choose a channel for calibration and link the module to a voltage source (or current source) and a multimeter.

Voltage Calibration:

The module, voltage sources, and meter are linked in **series**.

Current Calibration:

The module, current sources, and meter are linked in **parallel**.

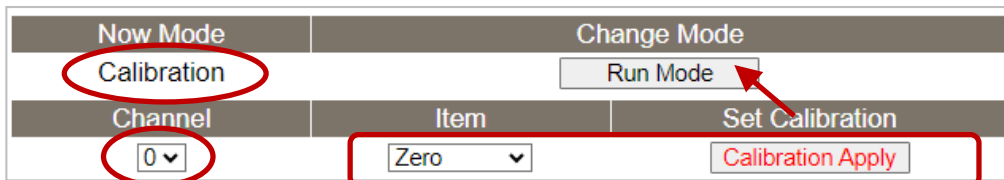
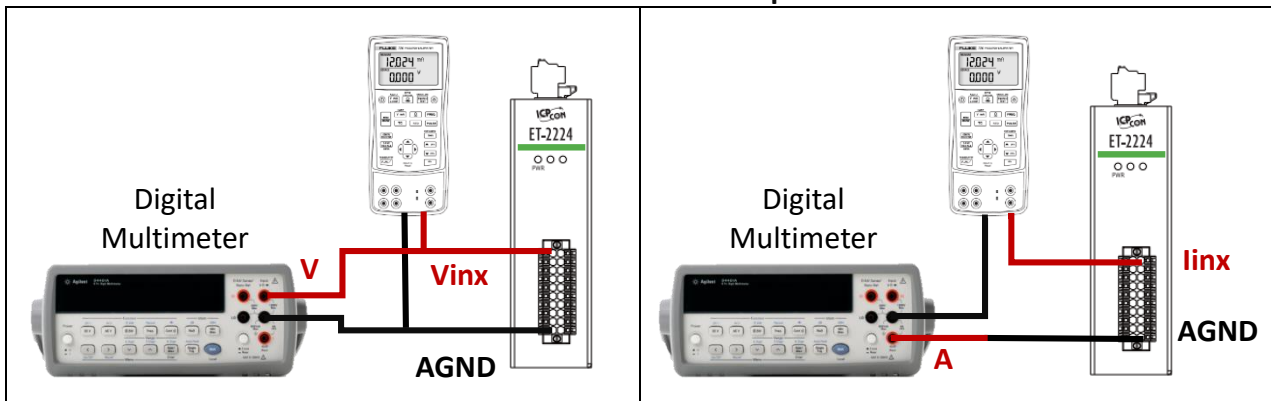

Step4: Choose the **Zero** calibration, input voltage (or current) via a digital multimeter, and check the input value using a multimeter. Click the **Calibration Apply** button to perform the calibration.

Note: The input voltage (or current) must be as close as the min/max value. For example,

Type	08: 0 ~ +10V	1A: 0 ~ +20mA
Zero Input Value	0V	0mA
Span Input Value	10V	20mA

Step5: Follow the same way to perform **Span** calibration.

Step6: After completing the Zero and Span calibration, click the **“Run Mode”** button to back to the Run mode.

Note: The user can click the **Restore Defaults** button on the **Network** page to restore the settings to the factory defaults.

(B) RTD Input

Analog Input Calibration

Analog Input Channel	Range	Zero Calibration Resistance	Span Calibration Resistance
AI0	86: Pt100, 0.00385, -100 ~ 300 °C	0 Ω	300 Ω
AI1	86: Pt100, 0.00385, -100 ~ 300 °C	0 Ω	300 Ω
AI2	86: Pt100, 0.00385, -100 ~ 300 °C	0 Ω	300 Ω
AI3	86: Pt100, 0.00385, -100 ~ 300 °C	0 Ω	300 Ω
AI4	86: Pt100, 0.00385, -100 ~ 300 °C	0 Ω	300 Ω
AI5	86: Pt100, 0.00385, -100 ~ 300 °C	0 Ω	300 Ω
AI6	86: Pt100, 0.00385, -100 ~ 300 °C	0 Ω	300 Ω
AI7	86: Pt100, 0.00385, -100 ~ 300 °C	0 Ω	300 Ω
AI8	86: Pt100, 0.00385, -100 ~ 300 °C	0 Ω	300 Ω
AI9	86: Pt100, 0.00385, -100 ~ 300 °C	0 Ω	300 Ω
AI10	86: Pt100, 0.00385, -100 ~ 300 °C	0 Ω	300 Ω
AI11	86: Pt100, 0.00385, -100 ~ 300 °C	0 Ω	300 Ω
AI12	86: Pt100, 0.00385, -100 ~ 300 °C	0 Ω	300 Ω
AI13	86: Pt100, 0.00385, -100 ~ 300 °C	0 Ω	300 Ω
AI14	86: Pt100, 0.00385, -100 ~ 300 °C	0 Ω	300 Ω
AI15	86: Pt100, 0.00385, -100 ~ 300 °C	0 Ω	300 Ω

AI Channel: AI0 ▾ Calibration Type: Zero ▾

Notes:

- It is recommended to set moving average to 128 during calibration for fast mode.
- For each range of each channel, the zero calibration must be performed first then the span calibration.

Reload Factory Calibration Parameters

Follow these steps to perform calibration:

Step1: In the **Analog Input Configuration** as noted in section 4.4.3, choose the "Fast" mode in the **Sampling Rates** field and enter "128" in the **Moving Average** field, then click the **Update Settings** button.

Analog Input Configuration:

Analog Input	Settings
Sampling Rates (00141)	Fast ▾
Moving Average (40497)	128 (1 ~ 128, Default = 1)

AI15	86 Pt100, α=0.00385, -100 ~ 300°C ▾	0.00	0.00
------	-------------------------------------	------	------

Note:

- It's recommended to set the **Moving Average** to "128" while calibrating in fast mode.
- When calibrating each I/O channel, the user must perform the Zero calibration before the Span calibration.

Step2: In the **Analog Input Calibration** section, specify the AI channel to be calibrated (e.g., "AI15") and connect a resistance with 0Ω . Next, choose "Zero" in the **Calibration Type** field and click the **Calibration** button.

AI15	86: Pt100, 0.00385, -100 ~ 300 °C	0Ω	300 Ω
AI Channel	AI15 <input type="text"/>	Calibration Type	Zero <input type="text"/>
Calibrate <input type="button"/>			

The way to connect resistance is just to plug it into the terminal. Choose the resistance with the lower temperature coefficient (PPM/°C).

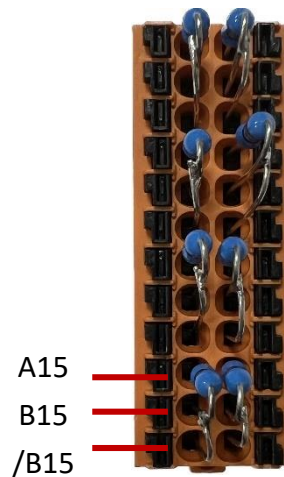
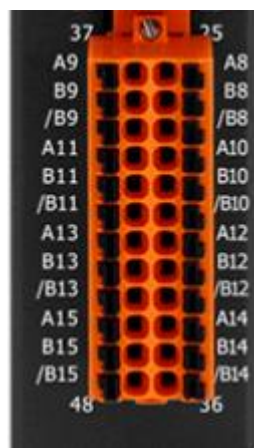

Step3: Connect a resistance with 300Ω to the specified channel (e.g., AI15) and choose "Span" in the **Calibration Type** field, and then click the **Calibration** button.

AI15	86: Pt100, 0.00385, -100 ~ 300 °C	0Ω	300 Ω
AI Channel	AI15 <input type="text"/>	Calibration Type	Span <input type="text"/>
Calibrate <input type="button"/>			

Now, the user have done the Zero/Span calibration. If it's necessary, the user can click the **Reload** button to restore the factory reset.

Reload Factory Calibration Parameters	Reload <input type="button"/>
--	-------------------------------

(C) Thermocouple Input



Analog Input Configuration:

Analog Input		Settings		
Sampling Rates (00141)	Fast			
Moving Average (40497)	128	(1 ~ 128, Default = 1)		
CJC, Cold Junction Compensation (00267)	Enable			
Module CJC Offset (40490)	0.0			
Analog Input Channel	Range (40212) <input type="checkbox"/> All as AI0	Temperature Offset (40288)	Channel CJC Offset (40384)	
AI0	0F Type K Thermocouple, -270 ~ 1372°C	0.0	0.0	
AI1	0E Type J Thermocouple, -210 ~ 760°C	0.0	0.0	
AI2	0F Type K Thermocouple, -270 ~ 1372°C	0.0	0.0	
AI3	10 Type T Thermocouple, -270 ~ 400°C	0.0	0.0	
AI4	11 Type E Thermocouple, -270 ~ 1000°C	0.0	0.0	
AI5	12 Type R Thermocouple, 0 ~ 1768°C	0.0	0.0	
AI6	13 Type S Thermocouple, 0 ~ 1768°C	0.0	0.0	
AI7	14 Type B Thermocouple, 0 ~ 1820°C	0.0	0.0	
AI8	15 Type N Thermocouple, -270 ~ 1300°C	0.0	0.0	
AI9	16 Type C Thermocouple, 0 ~ 2320°C	0.0	0.0	
AI10	17 Type L Thermocouple, -200 ~ 800°C	0.0	0.0	
AI11	18 Type M Thermocouple, -200 ~ 100°C	0.0	0.0	
AI12	19 Type LDIN43710 Thermocouple, -200 ~ 900°C	0.0	0.0	
AI13	0F Type K Thermocouple, -270 ~ 1372°C	0.0	0.0	
AI14	0F Type K Thermocouple, -270 ~ 1372°C	0.0	0.0	
AI15	0F Type K Thermocouple, -270 ~ 1372°C	0.0	0.0	

Update Settings

Follow these steps to perform calibration:

Step1: In the **Analog Input Configuration** section, choose the "Fast" mode in the **Sampling Rates** field and enter "128" in the **Moving Average** field.

Step2: Set the type for the channel that you want to calibrate (e.g, AI0, Type K), and click the **Update Settings** button.

Step3: In the **Analog Input Calibration** section, select the AI channel (e.g., "AI0") to be calibrated, choose "Zero" in the **Calibration Type** field, apply **0 mV** of input voltage, and click the **Calibration** button.

Analog Input Calibration

Analog Input Channel	Range	Zero Calibration Voltage	Span Calibration Voltage
AI0	0F: Type K Thermocouple, -270 ~ 1372 °C	0 mV	75 mV
AI1	0F: Type K Thermocouple, -270 ~ 1372 °C	0 mV	75 mV
AI2	0F: Type K Thermocouple, -270 ~ 1372 °C	0 mV	75 mV
AI3	0F: Type K Thermocouple, -270 ~ 1372 °C	0 mV	75 mV
AI4	0F: Type K Thermocouple, -270 ~ 1372 °C	0 mV	75 mV
AI5	0F: Type K Thermocouple, -270 ~ 1372 °C	0 mV	75 mV
AI6	0F: Type K Thermocouple, -270 ~ 1372 °C	0 mV	75 mV
AI7	0F: Type K Thermocouple, -270 ~ 1372 °C	0 mV	75 mV
AI8	0F: Type K Thermocouple, -270 ~ 1372 °C	0 mV	75 mV
AI9	0F: Type K Thermocouple, -270 ~ 1372 °C	0 mV	75 mV
AI10	0F: Type K Thermocouple, -270 ~ 1372 °C	0 mV	75 mV
AI11	0F: Type K Thermocouple, -270 ~ 1372 °C	0 mV	75 mV
AI12	0F: Type K Thermocouple, -270 ~ 1372 °C	0 mV	75 mV
AI13	0F: Type K Thermocouple, -270 ~ 1372 °C	0 mV	75 mV
AI14	0F: Type K Thermocouple, -270 ~ 1372 °C	0 mV	75 mV
AI15	0F: Type K Thermocouple, -270 ~ 1372 °C	0 mV	75 mV

AI Channel: AI0 ▾ Calibration Type: Zero ▾
 Zero
 Span

Calibrate

Notes:

- It is recommended to set moving average to 128 during calibration for fast mode.
- For each range of each channel, the zero calibration must be performed first then the span calibration.

Step4: Choose "Span" in the **Calibration Type** field, apply **75 mV** of input voltage to the specified channel, and then click the **Calibration** button.

AI Channel: AI0 ▾ Calibration Type: Span ▾
 Calibrate

For now, the user has completed the calibration.

4.4.5 AI - RTC

The function is used to set the system time and click the “**Update Settings**” button to save the revised settings to the ET-2200 module.

RTC	
Year	<input type="text" value="2022"/> (2000 to 2159)
Month	<input type="text" value="6"/> (1 to 12)
Date	<input type="text" value="13"/> (1 to 31)
Hour	<input type="text" value="11"/> (0 to 23)
Minute	<input type="text" value="5"/> (0 to 59)
Second	<input type="text" value="50"/> (0 to 59)
<input type="button" value="Update Settings"/>	

4.4.6 AI - Data Logger

Data Logger	
Status	Running
Change Logging	<input type="button" value="Run"/> ▾
Overwrite on Full	<input type="button" value="No"/> ▾
Sampling Interval - Second	<input type="text" value="1"/> (0 to 65535)
Sampling Interval - Millisecond	<input type="text" value="0"/> (0 to 1000, in 5 ms step)
Period Start - Year	<input type="text" value="2021"/> (2000 to 2159)
Period Start - Month	<input type="text" value="9"/> (1 to 12)
Period Start - Date	<input type="text" value="6"/> (1 to 31)
Period Start - Hour	<input type="text" value="11"/> (0 to 23)
Period Start - Minute	<input type="text" value="30"/> (0 to 59)
Period Start - Second	<input type="text" value="0"/> (0 to 59)
Period End - Year	<input type="text" value="2021"/> (2000 to 2159)
Period End - Month	<input type="text" value="9"/> (1 to 12)
Period End - Date	<input type="text" value="6"/> (1 to 31)
Period End - Hour	<input type="text" value="17"/> (0 to 23)
Period End - Minute	<input type="text" value="0"/> (0 to 59)
Period End - Second	<input type="text" value="0"/> (0 to 59)
<input type="button" value="Update Settings"/>	
<input type="button" value="Reset data logger to empty"/> <input type="button" value="Reset Data Logger"/>	

The table describes the parameters contained in the "**Data Logger**" section.

Item	Description
Status	Display the current status of data logging.
Change Logging	Set the status of data logging. It can be set to Stop, Run, Period, Pause, and Continue.
Overwrite on Full	Whether to overwrite data when it is full. It can be set to Yes or No.
Sampling Interval - Second	The time interval for logging data. (Range: 0-65535, Unit: second)
Sampling Interval - Millisecond	The time interval for logging data. (Range: 0-1000, in 5 ms step)
Period Start- Year, Month, Date, Hour, Minute, Second	The start time for logging data. (Year/Month/Date/Hour/Minute/ Second).
Period End- Year, Month, Date, Hour, Minute, Second	The end time for logging data. (Year/Month/Date/Hour/Minute/ Second).

➤ **Reset data logger to empty**

Click the "Reset Data Logger" button to remove data.

4.4.7 Analog Output Configuration

Analog Output Configuration

AO Channel	Type (40459~466)	Power On Value (40360~367)	Safe Value (40392~399)	Slew Rate (40523~530)	OVP Alarm Value (40580~587)	OVP Enable (00340~347)	Retained Enable (00769~776)
AO0:	0x32: 0 ~ +10V	0.000	0.000	0x00:Immediate	0.00	Disabled	Disabled
AO1:	0x30: 0 ~ 20mA	0.000	0.000	0x00:Immediate	0.00	Disabled	Disabled
AO2:	0x31: 4 ~ 20mA	0.000	0.000	0x00:Immediate	0.00	Disabled	Disabled
AO3:	0x32: 0 ~ +10V	0.000	0.000	0x00:Immediate	0.00	Disabled	Disabled
AO4:	0x34: 0 ~ +5V	0.000	0.000	0x00:Immediate	0.00	Disabled	Disabled
AO5:	0x32: 0 ~ +10V	0.000	0.000	0x00:Immediate	0.00	Disabled	Disabled
AO6:	0x32: 0 ~ +10V	0.000	0.000	0x00:Immediate	0.00	Disabled	Disabled
AO7:	0x32: 0 ~ +10V	0.000	0.000	0x00:Immediate	0.00	Disabled	Disabled
Modbus Format	Hexadecimal	Action: Modbus Read/Write Format Hexadecimal or Engineering					
Host Timeout (Safe Value/Enable, Seconds)	0	(5 ~ 65535 s, <5 = Default Disabled) Action:AO Output Safe Value					

The table describes the parameters contained in the "Analog Output Calibration" section.

Item	Description
AO Channel	
AO0 ~ AO7	<p>Set the data type, Power-on value, Safe value, and Slew Rate for each channel.</p> <p>Note that the "OVP Alarm Value", "OVP Enable", "Retained Enable" settings are only available for (P)ET-2224CIS, (P)ET-2228CIS.</p> <p>"OVP" stands for "Over-value Protection" which means when the AO value exceeds the set "OVP Alarm Value", the module will stop outputting values.</p>
Modbus Format	Set the data format. It can be Hexadecimal or Engineering
Host Timeout	This parameter is used to configure the Host Watchdog timeout value. If there is no Modbus TCP communication activity for the specified period (the timeout), the AO will be set to the user-defined safe value.
Update Settings	Click this button to save the changes.

4.4.8 AO - Calibration

Calibration

Now Mode		Change Mode	
Run		Calibration Mode	
Channel	Set Output	Set Calibration	
0 ▾	0 <input type="text"/> <input type="button" value="Set"/>	<input type="button" value="Calibration Apply"/>	

Warning: Incorrect manual calibration will cause your device's output imprecise.

1. Use "Calibration Mode" button to enter Calibration mode.
2. Select Channel & Type(0x30,0x31,0x32,0x33,0x34,0x35) for manual calibration, then press "Update Settings" on top.
3. Calibration Type 0x30(20mA) before Type 0x31(4mA).
4. Try the Engineering value(18800~18900[20mA], 6900~7100[4mA], 9900~9990[10V], 4900~4990[5V]), to get the full scale value.
5. Press "Set" to make the output change.
6. DMM(Digit Multimeter) is needed to measure the output as close as the full scale value.
7. Press "Calibration Apply" will calculate & store the value.

Note: Use "Restore Defaults" on Network page, can recover your calibration value from factory default.

The following table provides parameter notes for the **Calibration** section:

Item	Description
Calibration	
Now Mode	Used to display the current mode
Change Mode	Click the Calibration Mode (or Run Mode) button to change the mode
Channel	Choose the AO channel for calibration
Set Output	Enter the voltage/current output value
Set Calibration	Click the Calibration Apply button to perform calibration

Step1: In the **Analog Output Configuration** section of the **I/O Settings** page, Select the **Type** and **Modbus Format**, then click the **Update Settings** button to save the changes.

Analog Output Configuration

AO Channel	Type (40459~466)	Power On Value (40360~367)	Safe Value (40392~399)	Slew Rate (40523~530)
AO0:	0x32: 0 ~ +10V ▾	0.000	0.000	0x00:Immediate ▾
AO1:	0x32: 0 ~ +10V ▾	0.000	0.000	0x00:Immediate ▾
AO2:	0x32: 0 ~ +10V ▾	0.000	0.000	0x00:Immediate ▾
AO3:	0x32: 0 ~ +10V ▾	0.000	0.000	0x00:Immediate ▾
AO4:	0x32: 0 ~ +10V ▾	0.000	0.000	0x00:Immediate ▾
AO5:	0x32: 0 ~ +10V ▾	0.000	0.000	0x00:Immediate ▾
AO6:	0x32: 0 ~ +10V ▾	0.000	0.000	0x00:Immediate ▾
AO7:	0x32: 0 ~ +10V ▾	0.000	0.000	0x00:Immediate ▾
Modbus Format	Engineering ▾	Action: Modbus Read/Write Format Hexadecimal or Engineering		
Host Timeout (Safe Value/Enable, Seconds)	0	(10 ~ 65000 s, 0 = Default Disabled) Action:AO Output Safe Value		

Step2: In the **Calibration** section of the **I/O Settings** page, click the **Calibration Mode** button to get into the calibration mode.

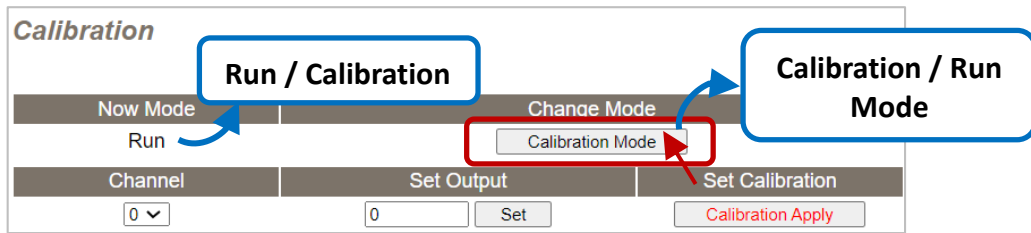

Step3: Choose a channel for calibration and link the module to the digital multimeter.

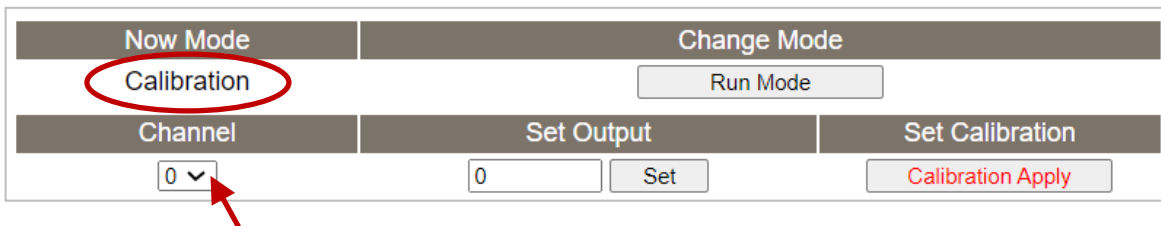

Voltage Calibration:

The module and digital multimeter are linked in **series**.

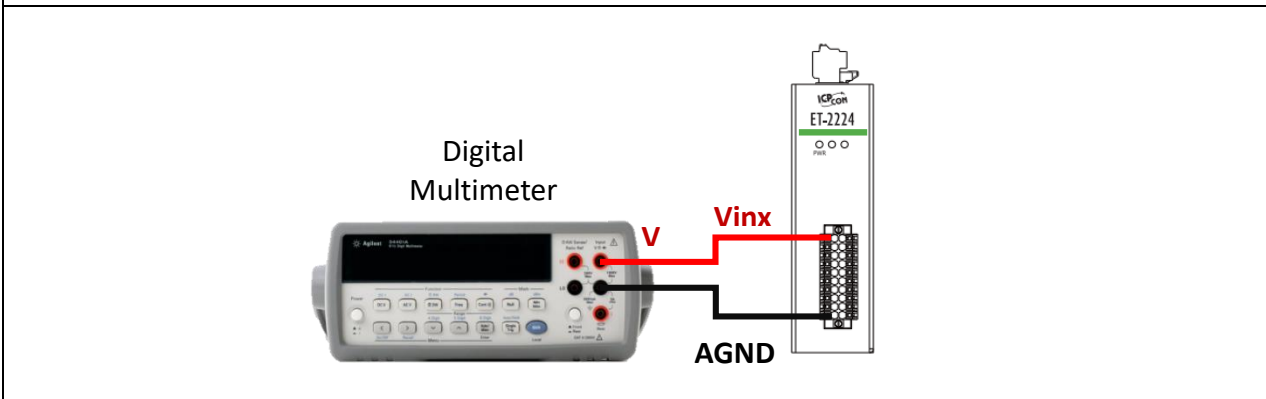

Current Calibration:

The module and digital multimeter are linked in **parallel**.

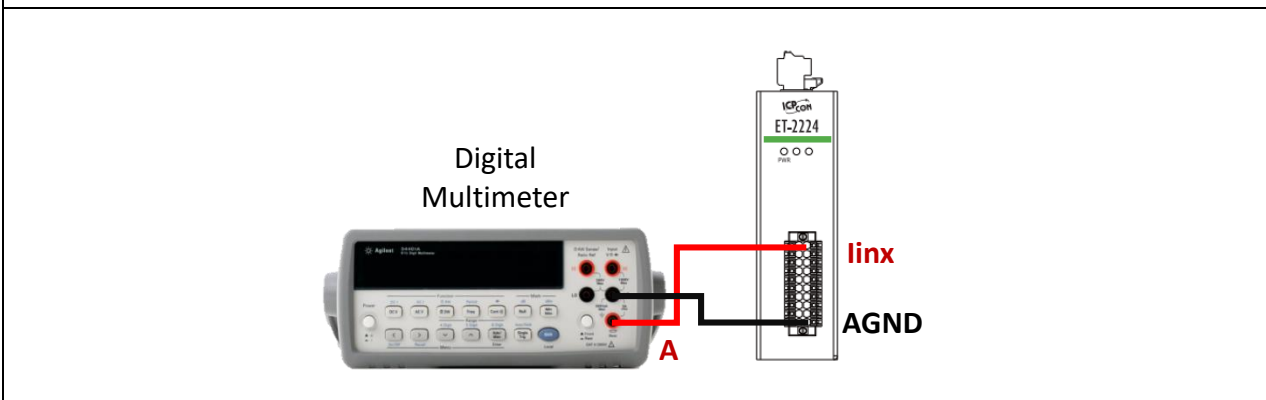

Step4: In the **Set Output** field, enter a maximum voltage (or current) value in Engineering format and click the **Set** button. Also, check the output value using a digital multimeter. Click the **Calibration Apply** button to perform the calibration.

Type	+10V	+5V	4mA	20mA
Full-scale Range	9900 ~ 9990	4900 ~ 4990	6900 ~ 7100	18800 ~ 18900

Note: The output voltage (or current) must be very close to the full-scale value.

For example, when calibrating a 10 V output, the output should be between 9900 and 9990. If the digital multimeter displays “10.0315V” while the output is set to 9900, the user can lower the output to the value (9960) that is closest to the 10 V shown on the digital multimeter. Afterward, click the **Calibration Apply** button.

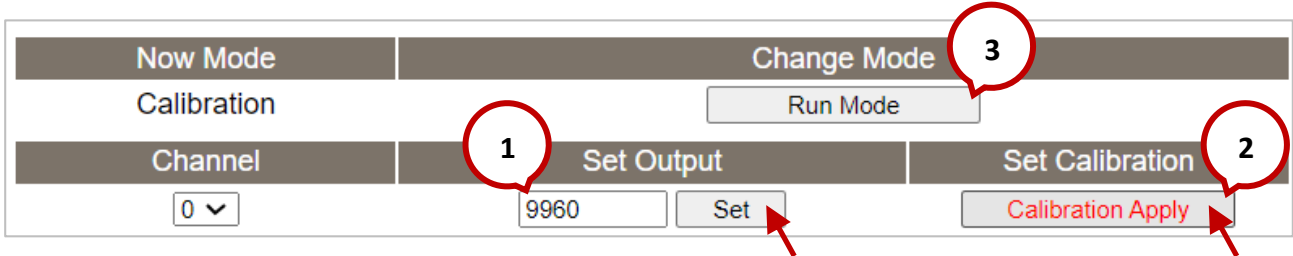

Step5: After completing the calibration, click the “**Run Mode**” button to back to the Run mode.

Note: The user can click the **Restore Defaults** button on the **Network** page to restore the settings to the factory defaults.

4.5 Sync

Note: The function is available for **DIO** modules.

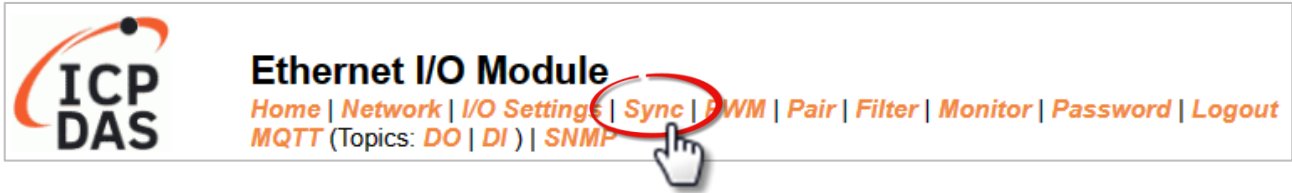

The **DIO Synchronization** section on the **Sync** page allows you to configure the Synchronous DIO, Min-switching time of DO, and Auto-off Time of DO for the ET-2200 series module, each of which will be described in more detail below.

4.5.1 DIO Synchronization

DIO Synchronization

Synchronous DIO (Local Mirror)	Modbus Address	Setting
Level Sync (DO=DI)	00403 - 00396	<input type="text" value="0x0"/> (CH 7 - 0: <input type="checkbox"/> <input type="checkbox"/> <input type="checkbox"/> <input type="checkbox"/> <input type="checkbox"/> <input type="checkbox"/> <input type="checkbox"/> <input type="checkbox"/>) Set the DO state to the same as the DI state.
Rising Active (DO=ON)	00419 - 00412	<input type="text" value="0x0"/> (CH 7 - 0: <input type="checkbox"/> <input type="checkbox"/> <input type="checkbox"/> <input type="checkbox"/> <input type="checkbox"/> <input type="checkbox"/> <input type="checkbox"/> <input type="checkbox"/>) Turn ON DO when DI is changed from OFF to ON.
Falling Active (DO=ON)	00435 - 00428	<input type="text" value="0x0"/> (CH 7 - 0: <input type="checkbox"/> <input type="checkbox"/> <input type="checkbox"/> <input type="checkbox"/> <input type="checkbox"/> <input type="checkbox"/> <input type="checkbox"/> <input type="checkbox"/>) Turn ON DO when DI is changed from ON to OFF.
Additional Controls	Modbus Address	Setting
Min-Switching Time of DO (0 to 65000 Seconds)	40283 - 40268	DO 15: <input type="text" value="0"/> DO 14: <input type="text" value="0"/> DO 13: <input type="text" value="0"/> DO 12: <input type="text" value="0"/> DO 11: <input type="text" value="0"/> DO 10: <input type="text" value="0"/> DO 09: <input type="text" value="0"/> DO 08: <input type="text" value="0"/> DO 07: <input type="text" value="0"/> DO 06: <input type="text" value="0"/> DO 05: <input type="text" value="0"/> DO 04: <input type="text" value="0"/> DO 03: <input type="text" value="0"/> DO 02: <input type="text" value="0"/> DO 01: <input type="text" value="0"/> DO 00: <input type="text" value="0"/>
		DO 15: <input type="text" value="0"/> DO 14: <input type="text" value="0"/> DO 13: <input type="text" value="0"/> DO 12: <input type="text" value="0"/> DO 11: <input type="text" value="0"/> DO 10: <input type="text" value="0"/> DO 09: <input type="text" value="0"/> DO 08: <input type="text" value="0"/> DO 07: <input type="text" value="0"/> DO 06: <input type="text" value="0"/> DO 05: <input type="text" value="0"/> DO 04: <input type="text" value="0"/> DO 03: <input type="text" value="0"/> DO 02: <input type="text" value="0"/> DO 01: <input type="text" value="0"/> DO 00: <input type="text" value="0"/>
Auto-off Time of DO (0 to 65000 Seconds)	40299 - 40284	DO 15: <input type="text" value="0"/> DO 14: <input type="text" value="0"/> DO 13: <input type="text" value="0"/> DO 12: <input type="text" value="0"/> DO 11: <input type="text" value="0"/> DO 10: <input type="text" value="0"/> DO 09: <input type="text" value="0"/> DO 08: <input type="text" value="0"/> DO 07: <input type="text" value="0"/> DO 06: <input type="text" value="0"/> DO 05: <input type="text" value="0"/> DO 04: <input type="text" value="0"/> DO 03: <input type="text" value="0"/> DO 02: <input type="text" value="0"/> DO 01: <input type="text" value="0"/> DO 00: <input type="text" value="0"/>
<input type="button" value="Update Settings"/>		

The table describes the parameters contained in the "**DIO Synchronization**" section.

Item	Description
Synchronous DIO (Local Mirror) Note: ET-2254 supports these functions when low 8-bit is DI0 to DI7 and high 8-bit is DO8 to DO15.	
Level Sync (DO = DI)	This parameter is used to enable the synchronization operation in Digital Input/Output function.
Rising Active (DO = ON)	This parameter is used to enable rising activation in the Digital Input function. When the specified DI state changes from OFF to ON, the corresponding DO will be set to ON.
Falling Active (DO = ON)	This parameter is used to enable falling activation in the Digital Input function. When the specified DI state changes from ON to OFF, the corresponding DO will be set to ON.
Additional Controls	
Min-Switch Time of DO (0 to 65535 Seconds)	This parameter is used to set the minimum switching time between the ON and OFF states of the Digital Output. This protects some machines from being damaged by too many ON/OFF switches in a short time.
Auto-off Time of DO (0 to 65535 Seconds)	This parameter is used to set the auto-off time of the Digital Output. If the Digital Output is ON, the Digital Output will be auto-off based on the configured time value.
Update Settings	Click this button to save the changes

4.6 PWM

Note: The function is available for **DIO** modules.

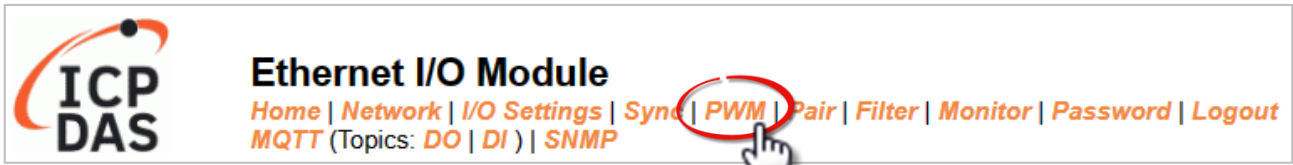

The **PWM Configuration** section on the **PWM** page allows you to enable and configure the PWM parameters for the ET-2200 series module, including the PWM Alarm and duty cycle, etc., each of which will be described in more detail below.

Note: Because of the characteristics of the relay functions, it is recommended that the PWM on the ET-2260/2261/2268 module (i.e., modules with relay functions) is not used for extended periods.

4.6.1 PWM Configuration

PWM Configuration:

PWM Functions	Modbus Address	Setting
Enable PWM	00107 - 00100	0x0 (CH 7 - 0: <input type="checkbox"/> <input type="checkbox"/> <input type="checkbox"/> <input type="checkbox"/> <input type="checkbox"/> <input type="checkbox"/> <input type="checkbox"/> <input type="checkbox"/>)
Enable PWM Alarm	00371 - 00364	0x0 (CH 7 - 0: <input type="checkbox"/> <input type="checkbox"/> <input type="checkbox"/> <input type="checkbox"/> <input type="checkbox"/> <input type="checkbox"/> <input type="checkbox"/> <input type="checkbox"/>) (Activates the PWM/DO outputs when Host/Slave Watchdog Timeout)
Duty Cycle	40115 - 40100	DO 07: (<input type="text" value="0"/> , <input type="text" value="0"/>) DO 06: (<input type="text" value="0"/> , <input type="text" value="0"/>) DO 05: (<input type="text" value="1000"/> , <input type="text" value="1000"/>) DO 04: (<input type="text" value="1000"/> , <input type="text" value="1000"/>) DO 03: (<input type="text" value="1000"/> , <input type="text" value="1000"/>) DO 02: (<input type="text" value="1000"/> , <input type="text" value="1000"/>) DO 01: (<input type="text" value="1000"/> , <input type="text" value="1000"/>) DO 00: (<input type="text" value="1000"/> , <input type="text" value="1000"/>) (High, Low: 10 ~ 65000 ms, 0= Disable)
<input type="button" value="Update Settings"/>		

The table describes the parameters contained in the "PWM Configuration" section.

Item	Description	Defaults
Enable PWM	This parameter is used to enable the PWM output function.	0
Enable PWM Alarm	This parameter is used to enable the PWM output alarm function when the Host/Slave watchdog timeout.	0
Duty Cycle	This parameter is used to set the duty cycle for the DO channels. Two values are required for each DO channel. The first value is the high pulse width, while the second is the low pulse width. The duty cycle is in 1 ms units, and the resolution is approximately 5 ms. (10 to 65535 ms). A value of 0 will disable the duty cycle functions for that channel.	1000 (ms)
Update Settings	Click this button to save the changes.	

4.7 Pair Connection



On the **Pair** page, within the **Pair Connection Settings** section, users can enable and configure the I/O pair-connection function of the module using Modbus TCP. This allows for the establishment of logic connections between Local and remote I/O, as explained below.

4.7.1 I/O Pair-Connection Settings

Note: The configuration page varies based on the I/O type.

E.g., ET-2217CI

Pair-Connection Settings:

PULL Mode: (Remote AI -> Local AO)
 PUSH Mode: (Local AI -> Remote AO)

| 1~5 | 6~10 | 11~12 |

#	Mode	Remote IP	Remote Port	Net ID	Scan Time	AI Count	AI Addr	AO Addr	TCP/UDP	Update
01	Disable	0 . 0 . 0 . 0	502	1	1000 ms	0	0	0	TCP	Submit
02	Disable	0 . 0 . 0 . 0	502	1	1000 ms	0	0	0	TCP	Submit
03	Disable	0 . 0 . 0 . 0	502	1	1000 ms	0	0	0	TCP	Submit
04	Disable	0 . 0 . 0 . 0	502	1	1000 ms	0	0	0	TCP	Submit
05	Disable	0 . 0 . 0 . 0	502	1	1000 ms	0	0	0	TCP	Submit

The analog input (AI) modules only support the **Push** mode (Local AI to Remote AO).

E.g., ET-2224/28

Pair-Connection Settings:

| Submit 1-4 | 5-8 |

#	Enable Mode	Remote IPv4 / IPv6 / Host Name (Max. 127 chars)	Remote Port	Net ID	Scan Time (ms)	AI Address	AO Address	Network Protocol
01	<input type="checkbox"/> PULL	0.0.0.0	502	1	1000	0	0	TCPv4
02	<input type="checkbox"/> PULL	0.0.0.0	502	1	1000	0	0	TCPv4
03	<input type="checkbox"/> PULL	0.0.0.0	502	1	1000	0	0	TCPv4
04	<input type="checkbox"/> PULL	0.0.0.0	502	1	1000	0	0	TCPv4

Note:
Only Support TCP PULL Mode = Remote AI to Local AO. Data Format must be Engineering

The analog output (AO) modules only support the **Pull** mode (Remote AI to Local AO).



Ethernet I/O Module
[Home](#) | [Network](#) | [I/O Settings](#) | [Sync](#) | [PWM](#) | [Pair](#) | [Filter](#) | [Monitor](#) | [Password](#) | [Logout](#)
[MQTT](#) (Topics: [DO](#) | [DI](#)) | [SNMP](#)

DI/DO Module

Pair-Connection Settings: | [Submit 1-8](#) | [9-16](#) |

#	Enable Mode	Remote IPv4 / IPv6 / Host Name (Max. 127 chars) : Port	Net ID	Scan Time (ms)	IO Count	Local IO Address	Remote IO Address	Network Protocol
01	<input type="checkbox"/> PUSH	502	1	1000	1	0x:Coil 0 0	0x:Coil 0 0	TCPv4
02	<input type="checkbox"/> PULL	502	1	1000	1	0x:Coil 0 0	0x:Coil 0 0	TCPv4
03	<input type="checkbox"/> PULL	502	1	1000	1	0x:Coil 0 0	0x:Coil 0 0	TCPv4
04	<input type="checkbox"/> PULL	502	1	1000	1	0x:Coil 0 0	0x:Coil 0 0	TCPv4
05	<input type="checkbox"/> PULL	502	1	1000	1	0x:Coil 0 0	0x:Coil 0 0	TCPv4
06	<input type="checkbox"/> PULL	502	1	1000	1	0x:Coil 0 0	0x:Coil 0 0	TCPv4
07	<input type="checkbox"/> PULL	502	1	1000	1	0x:Coil 0 0	0x:Coil 0 0	TCPv4
08	<input type="checkbox"/> PULL	502	1	1000	1	0x:Coil 0 0	0x:Coil 0 0	TCPv4

Note:
 PULL Mode = Remote to Local
 PUSH Mode = Local to Remote
 Pair-connection is disabled if the IO Count is 0 (no data)
 IO Address (base 0): 0 - 65535, no leading 0x/1x/3x/4x.

The table describes the parameters contained in the "I/O Pair-Connection Settings" section.

Item	Description	Defaults
Enable Mode	Used to enable or disable the Client (Master) function and select either PULL or PUSH mode. PULL Mode: To read the remote AI (or DI) and write to the local AO (or DO). PUSH Mode: To read the local AI (or DI) and write to the remote AO (or DO).	Disable
Remote IP	Used to set the IP address or the hostname of the remote module. Before entering the Host Name, ensure that the correct DNS has been set on the Network page.	0
Remote Port	Used to set the TCP port number of the remote device. The valid range is 0 - 65535.	502
Net ID	Used to set the Modbus Net ID of the remote device. The valid range is 1 - 247.	1

Item	Description	Defaults
Scan Time	<p>In "PULL" mode, the module will update its I/O data based on the specified scan time.</p> <p>In "PUSH" mode, If the local DI/AI changes, the module will immediately update the remote DO/AO. Furthermore, even if the local DI/AI remains unchanged throughout the scan time, the module will still update the remote DO/AO.</p> <p>The valid range is 1000 to 42949672965 (ms)</p>	1000 ms
AIO	AI Count	0
	AI Address	0
	AO Address	0
DIO	IO Count	0
	Local IO Address	0
	Remote IO Address	0
Network Protocol (TCP/UDP)	Used to set the type of Modbus protocol to be used and can be TCPv4/TCPv6 or UDPv4/ UDPv6	TCPv4
Submit	Click this button to save the changes.	

4.8 Filter

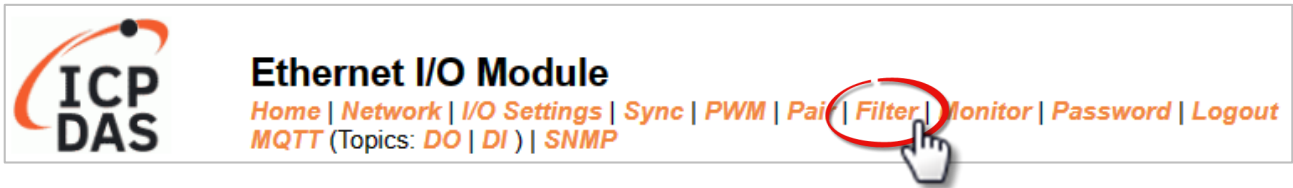

The **Filter Settings** section on the **Filter** page allows you to configure the IP Filter list for the ET-2200 series module, which will be described in more detail below.

4.8.1 Filter Settings

The **Filter Settings** function is used to query or set the IP Filter List (Available IP) for the ET-2200 series module. Only Clients whose IP address is specified in the list will be able to access the ET-2200 series module. Note that some of the modules do not support the IPv6 setting.

Filter Setting:

Accessible IP	IPv4/v6 Address (example: 10.0.8.123, fe80:0:0:0:a8ee:dc07:1cda:5678)
IP1	<input type="text"/>
IP2	<input type="text"/>
IP3	<input type="text"/>
IP4	<input type="text"/>
IP5	<input type="text"/>
Enable IP Filter	<input type="checkbox"/> Check to enable. (Default disabled)

Note: Remember to include the IP address of your configuration computer.

The table describes the parameters contained in the "IP Address Configuration" section.

Item	Description
IP1 ~ IP5	Enter the accessible IP address (IPv4 or IPv6). Note that remember to enter the IP address of the PC used to configure the module.
Enable IP Filter	Check the item to enable the function (Defaults: Disabled).
Update Settings	Click this button to save the changes.

4.9 Monitor

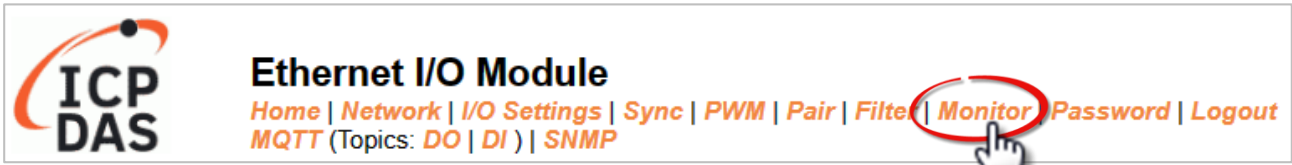

After clicking the **Monitor** tab, the user can check the connection status of the ET-2200 series module in the **Current Connection Status** section. Note that some of the modules only display IP addresses for the Server mode.

Current Connection Status:

Server Mode	Connected IP	Server Mode	Connected IP
IP1	-	IP2	-
IP3	-	IP4	-
IP5	-	IP6	-
IP7	-	IP8	-
IP9	-	IP10	-
IP11	-	IP12	-
Available Connections	32		

Client Mode	Remote IP	Connection State	Query State	Last Query Time	Host Name
IP1	-	-	-	-	-
IP2	-	-	-	-	-
IP3	-	-	-	-	-
IP4	-	-	-	-	-
IP5	-	-	-	-	-
IP6	-	-	-	-	-
Client Mode	Remote IP	Connection State	Query State	Last Query Time	Host Name
IP7	-	-	-	-	-
IP8	-	-	-	-	-
IP9	-	-	-	-	-
IP10	-	-	-	-	-
IP11	-	-	-	-	-
IP12	-	-	-	-	-

Item	Description
Server Mode (IP1 to IP12)	Display the connected IP address.
Available Connection	When used as a slave device, a maximum of 32 connections is allowed
Client Mode (IP1 to IP12)	Display the remote IP address, the connection state, the request state, the last query time, and the login hostname.

4.10 Change Password

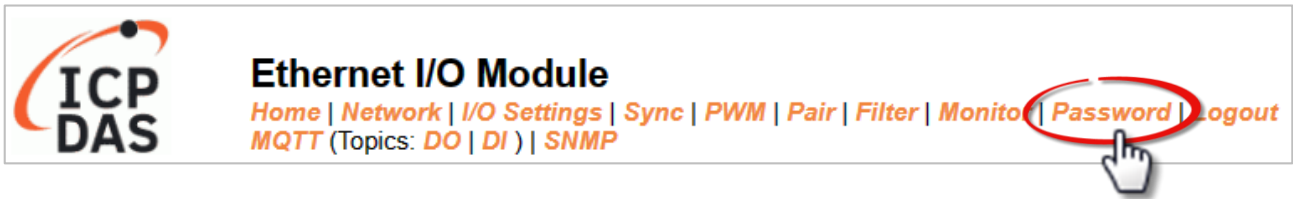

The **Password** page allows you to change the password that used to log in to ET-2200, follow the steps.

- Step 1: Enter the old password in the “**Current password**” field. The first time you change the password, enter the default password “**Admin**”.
- Step 2: Enter a new password in the “**New password**” field.
(please enter 1 to 12 digits of numbers or characters).
- Step 3: Re-enter the new password in the “**Confirm new password**” field.
- Step 4: Click the “**Submit**” button to update the password.

Change Password

The length of the password is 12 characters maximum.

Current password:	<input type="password" value="....."/>
New password:	<input type="password" value="...."/>
Confirm new password:	<input type="password" value="...."/>

 **Note:** If you forgot the password, refer to Appendix A1. How do I restore the web password for the module to the factory default password?

4.11 Logout

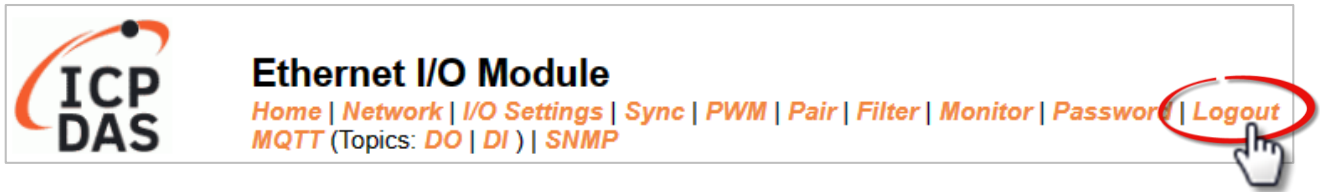

Clicking the **Logout** tab will immediately log out from the system and return to the login page.

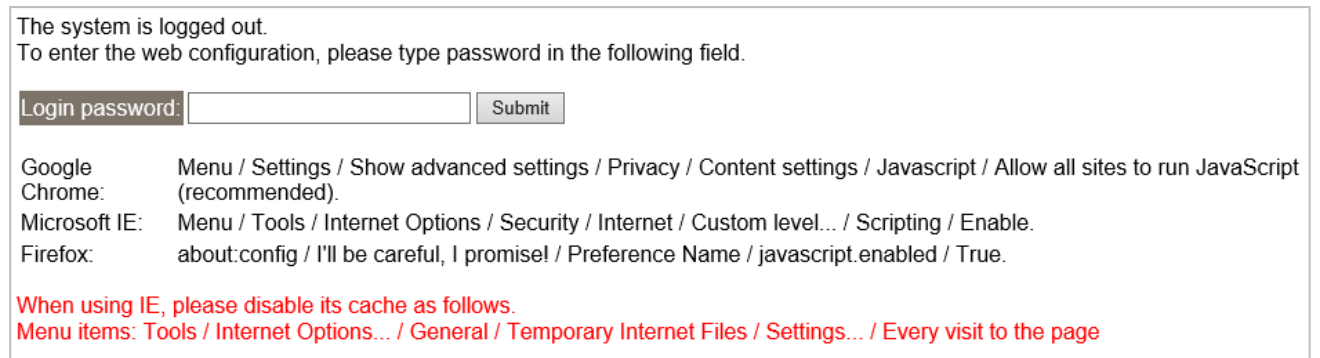

4.12 MQTT

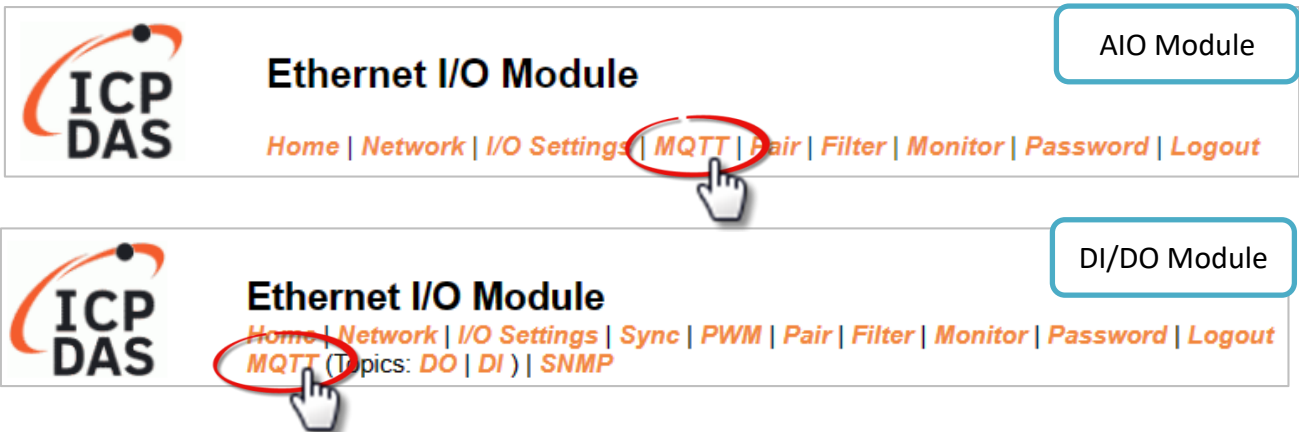

The MQTT architecture mainly consists of a server (Broker) and clients (Clients). Each MQTT Client requires a unique identifier, and the MQTT Broker identifies users based on these identifiers and records their status, such as subscribed topics and communication quality. Clicking on the **MQTT** tab opens the MQTT settings page.

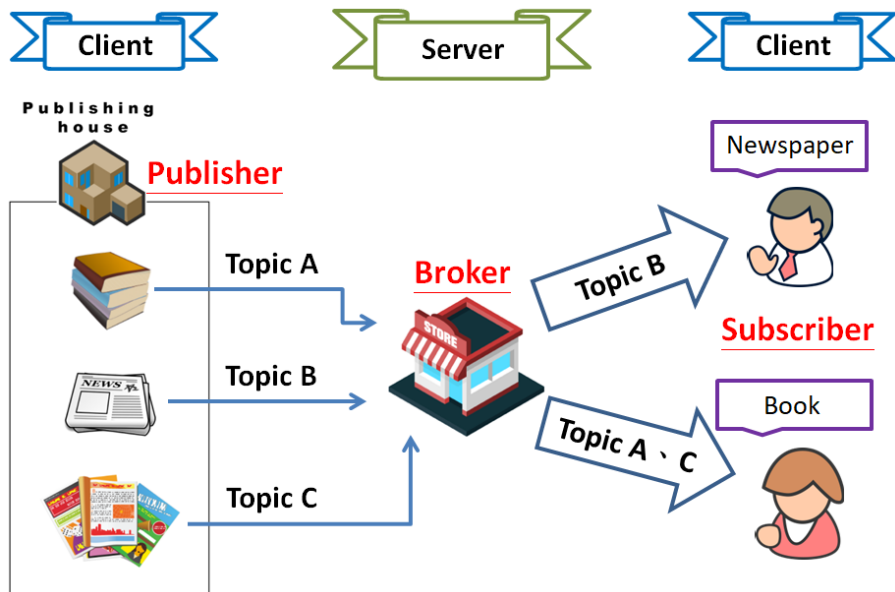

MQTT is a protocol consisting of a Publish/Subscribe mechanism where the Client only needs to know the IP address of the Broker. The Publisher is responsible for sending topic messages, while the Subscriber is responsible for receiving new messages from the Broker. The Broker then acts as a central location to handle the sending and receiving of all messages between a Publisher and a Subscriber.

When the Publisher updates a message related to a specific topic, it is transmitted to the Broker, which will then send the message to all Subscribers that have subscribed to that particular topic. Neither the Publisher nor the Subscriber needs to know the status of the other.

4.12.1 Connectivity Settings

Connectivity Settings	
MQTT	Disable ▾
Broker	IPv4 / Host Name (Max. 127 chars) 10.0.8.1
Broker Port	1883 (Default= 1883)
Client Identifier	ET-2260_65E985
User Name	(Max. 63 chars)
Password	(Max. 63 chars)
Reconnection Interval	10 (5 ~ 65000 s, Default= 10)
Keep Alive Interval	20 (5 ~ 65000 s, Default= 20)
Main Topic Name	N/A (Max. 126 chars)
Update Settings	

The table describes the parameters contained in the "Connectivity Settings" section.

Item	Description	Defaults
MQTT	Enables or Disables the MQTT connection function.	Disabled
Broker	Set the IP address or Hostname of the PC where the MQTT broker is installed. (E.g., broker.emqx.io or broker.hivemq.com)	N/A
Broker Port	The port number for the MQTT broker.	1883
Client Identifier	The client identifier uniquely identifies the MQTT client to the MQTT broker, and consists of the “module name”+ “_” (underscore character) + “the last 6 digits of the MAC address” and cannot be changed.	
User Name	This parameter is used when the MQTT broker requires authentication. The length should be no more than 63 characters.	N/A
Password	This parameter is used when the MQTT broker requires authentication. The length should be no more than 63 characters.	N/A
Reconnection Interval	The time interval between attempts by the ET-2200 module to connect to the broker if a connection failure occurs. The valid range is 5 to 65000 seconds	10(s)

<p>Keep Alive Interval</p>	<p>The keep-alive mechanism is provided to ensure that both the client and the broker are alive and the connection is still open.</p> <p>If a Client doesn't send any messages during the Keep Alive period, it must send a PINGREQ packet to the broker to confirm its availability. The broker must reply with a PINGRESP packet to also indicate its availability. The broker will disconnect a client, which doesn't send a PINGREQ packet or any other message within one and a half times of the Keep Alive Interval. The valid range is 5 to 65000 seconds.</p>	<p>20(s)</p>
<p>Main Topic Name</p>	<p>The Topic Name is a combination of the Main Topic Name and the Sub Topic Name. The Main Topic Name can be empty. The same part of the Topic Names can be entered in the Main Topic Name field to improve the processing efficiency of all Topic Names. A shorter Topic Name also improves processing efficiency.</p>	<p>N/A</p>
<p>Update Settings</p>	<p>Click this button to save the changes.</p>	

4.12.2 Publication Settings

Publication Settings

Publication	
Retain	<input type="checkbox"/>
Cycle	9000 (100 ~ 2147483000 ms, in 10 ms step, Default= 9000)
All Information	
Enable	Disable ▾
Sub Topic Name	info (Max. 63 chars)
Last Will and Testament	
Enable	<input type="checkbox"/>
Retain	<input type="checkbox"/>
QoS	0 - At most once ▾
Topic	N/A (Max. 63 chars)
Message	N/A (Max. 63 chars)
Update Settings	

The table describes the parameters contained in the "Publication Settings" section.

Item	Description	Defaults
Publication		
Retain	Check this option to ensure that the message is retained once it is published.	Disabled
Cycle	The time interval that the ET-2200 module periodically publishes data. The valid range is 100 to 2147483000 milliseconds in intervals of 10 milliseconds.	9000(ms)
All Information		
Enable	This option is used to enable or disable the All Information function. All Information adopts Periodic Publish, which includes the Module Name, the MAC address, DI, and DO states. The publishing period depends on the Cycle setting.	Disabled
Sub Topic Name	The Topic Name is a combination of the Main Topic Name and the Sub Topic Name. A shorter Topic Name improves processing efficiency.	info

Item	Description	Defaults
Last Will and Testament		
Enable	Check this option to enable the Last Will and Testament function.	Disabled
Retain	Check this option to ensure that the Last Will and Testament message is retained once it is published.	Disabled
QoS	The QoS for the Last Will and Testament message.	0 - At most once
Topic	The Topic Name for the last will and Testament message. The length should be no more than 63 characters	N/A
Message	The Last Will and Testament message. The length should be no more than 63 characters.	N/A
Update Setting	Click this button to save the changes	

4.12.3 Restore Factory Defaults

Restore Factory Defaults

Restore MQTT factory settings	<input type="button" value="Restore Defaults"/>
Restart MQTT service	<input type="button" value="Restart Service"/>

The table describes the parameters contained in the "**Restore Factory Defaults**" section.

Item	Description
Restore MQTT factory settings	Click this button to reset all MQTT settings to the default factory settings.
Restart MQTT service	Click this button to restart the MQTT service. This function should be used to reconnect with the Broker after adjusting the MQTT settings.

4.13 MQTT-DO

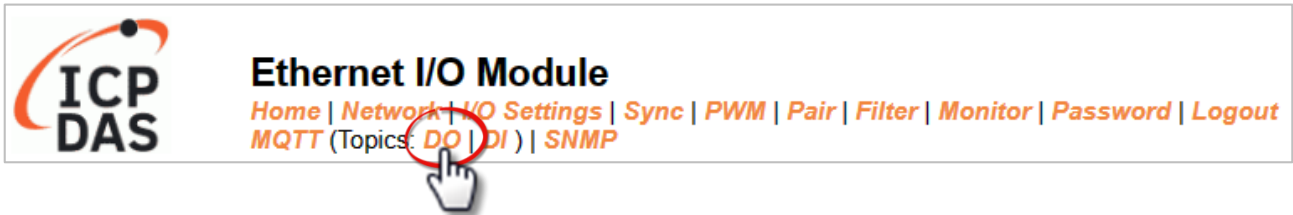

The DO page is where you can set a full Topic Name, which is a combination of the Sub Topic Name and the Main Topic name. The Publish and Subscribe functions for each DO channel can be enabled or disabled on this page. You can use either a single-channel (DO0...) or multiple channels (ALL) to process the Topic operations. Multi-channel operation is recommended because it can help reduce the amount of network traffic.

In single-channel operation, the values 0 and 1 correspond to the OFF and ON settings, respectively. In multi-channel operation, a hexadecimal value represents the settings for all channels. For example, the value 0xFF00 indicates that channels 0 to 7 are OFF and channels 8 to 15 are ON. Please turn off unused Topics to reduce unnecessary processing, as it will affect operational efficiency.

4.13.1 MQTT – Digital Outputs

MQTT - Digital Outputs

Digital Output	Power-on Publish	Subscribe	Sub Topic Name (Max. 63 chars)
ALL	<input type="checkbox"/>	<input type="checkbox"/>	do_all
Digital Output	<input type="checkbox"/> Power-on Publish	<input type="checkbox"/> Subscribe	Sub Topic Name (Max. 63 chars)
DO0	<input type="checkbox"/>	<input type="checkbox"/>	do00
DO1	<input type="checkbox"/>	<input type="checkbox"/>	do01
DO2	<input type="checkbox"/>	<input type="checkbox"/>	do02
DO3	<input type="checkbox"/>	<input type="checkbox"/>	do03
DO4	<input type="checkbox"/>	<input type="checkbox"/>	do04
DO5	<input type="checkbox"/>	<input type="checkbox"/>	do05
DO6	<input type="checkbox"/>	<input type="checkbox"/>	do06
DO7	<input type="checkbox"/>	<input type="checkbox"/>	do07
<input type="button" value="Update"/>			

The table describes the parameters contained in the "MQTT – Digital Outputs" section.

Item	Description	Defaults
Power-on Publish	The DO status will be published when the module is Powered-on. Check the box to enable and uncheck it to disable the function	Disabled
Subscribe	The DO states depend on the updating message of the corresponding Topic. Check the box to enable and uncheck it to disable the function	Disabled
Sub Topic Name	The Topic Name is a combination of the Main Topic Name and the Sub Topic Name. A shorter Topic Name improves processing efficiency.	Corresponding DO
Update	Click this button to save the changes.	

4.13.2 Readbacks of the Digital Outputs

Readbacks of the Digital Outputs

Readback	State-Change Publish	Periodic Publish	Sub Topic Name (Max. 63 chars)
ALL	<input type="checkbox"/>	<input type="checkbox"/>	rb_all
Readback	<input type="checkbox"/> State-Change Publish	<input type="checkbox"/> Periodic Publish	Sub Topic Name (Max. 63 chars)
DO0	<input type="checkbox"/>	<input type="checkbox"/>	rb00
DO1	<input type="checkbox"/>	<input type="checkbox"/>	rb01
DO2	<input type="checkbox"/>	<input type="checkbox"/>	rb02
DO3	<input type="checkbox"/>	<input type="checkbox"/>	rb03
DO4	<input type="checkbox"/>	<input type="checkbox"/>	rb04
DO5	<input type="checkbox"/>	<input type="checkbox"/>	rb05
DO6	<input type="checkbox"/>	<input type="checkbox"/>	rb06
DO7	<input type="checkbox"/>	<input type="checkbox"/>	rb07
<input type="button" value="Update"/>			

The table describes the parameters contained in the "Readbacks of the Digital Outputs" section.

Item	Description	Default Value
State-Change Publish	Publish the message when DO status changes. Please select the box to enable this function or unselect to disable it.	Disabled
Periodic Publish	Publish the DO status periodically according to the Cycle settings. Please select the box to enable this function or unselect to disable it.	Disabled
Sub Topic Name	The Topic Name is a combination of the Main Topic Name and the Sub Topic Name. A shorter Topic Name improves processing efficiency.	Corresponding DO
Update	Click this button to save the changes.	

4.14 MQTT-DI

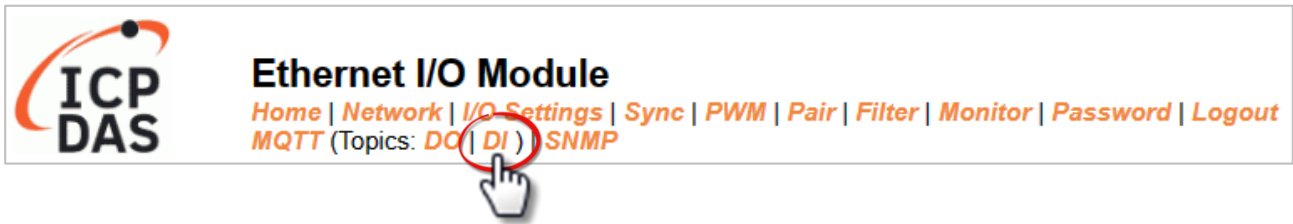

The DI page is where you can set the Topic Name, which is a combination of the Sub Topic Name and the Main Topic name. The Publish function for each DI channel can also be either enabled or disabled on this page. You can use either a single-channel (DI0...) or multiple-channels (ALL) to process the Topic operations. Multi-channel operation is recommended because it can help reduce the amount of network traffic.

In single-channel operation, the values 0 and 1 correspond to the OFF and ON settings, respectively. In multi-channel operation, a hexadecimal value represents the settings for all channels. For example, the value 0xFF00 indicates that channels 0 to 7 are OFF, and channels 8 to 15 are ON. Please turn off (uncheck the checkbox) unused Topics to reduce unnecessary processing, as it will affect operational efficiency.

4.14.1 MQTT – Digital Inputs

MQTT - Digital Inputs

Digital Input	State-Change Publish	Periodic Publish	Sub Topic Name (Max. 63 chars)
ALL	<input type="checkbox"/>	<input type="checkbox"/>	di_all
Digital Input	<input type="checkbox"/> State-Change Publish	<input type="checkbox"/> Periodic Publish	Sub Topic Name (Max. 63 chars)
D10	<input type="checkbox"/>	<input type="checkbox"/>	di00
D11	<input type="checkbox"/>	<input type="checkbox"/>	di01
D12	<input type="checkbox"/>	<input type="checkbox"/>	di02
D13	<input type="checkbox"/>	<input type="checkbox"/>	di03
D14	<input type="checkbox"/>	<input type="checkbox"/>	di04
D15	<input type="checkbox"/>	<input type="checkbox"/>	di05
D16	<input type="checkbox"/>	<input type="checkbox"/>	N/A
D17	<input type="checkbox"/>	<input type="checkbox"/>	N/A
<input type="button" value="Update"/>			

The table describes the parameters contained in the "MQTT – Digital Inputs" section.

Item	Description	Default Value
State-Change Publish	Publish the message when DI status changes. Please select the box to enable this function or unselect to disable it.	Disabled
Periodic Publish	Publish the DI status periodically according to the Cycle settings. Please select the box to enable this function or unselect to disable it.	Disabled
Sub Topic Name	The Topic Name is a combination of the Main Topic Name and the Sub Topic Name. A shorter Topic Name improves processing efficiency.	Corresponding DI
Update	Click this button to save the changes.	

4.15 MQTT-AI



Analog Inputs

Analog Input	<input type="checkbox"/> Periodic Publish	Sub Topic Name (Max. 63 chars)
AI0	<input checked="" type="checkbox"/>	ai00
AI1	<input checked="" type="checkbox"/>	ai01
AI2	<input checked="" type="checkbox"/>	ai02
AI3	<input checked="" type="checkbox"/>	ai03
AI4	<input checked="" type="checkbox"/>	ai04
AI5	<input checked="" type="checkbox"/>	ai05
AI6	<input checked="" type="checkbox"/>	ai06
AI7	<input checked="" type="checkbox"/>	ai07
<input type="button" value="Update"/>		

The table describes the parameters contained in the "MQTT – Analog Inputs" section.

Item	Description	Defaults
Periodic Publish	To publish AI values regularly based on the Cycle value (see MQTT – Publication Settings). Click the box on the top side to select all channels; click again to deselect all channels.	Disabled
Sub Topic Name	The Topic Name is a combination of the Main Topic Name and the Sub Topic Name. A shorter Topic Name improves processing efficiency.	Corresponding AI
Update	Click this button to save the changes.	

4.16 MQTT Realization

This section described how to use the open-source software Mosquitto and MQTTX to demonstrate the usage of MQTT protocol in conjunction with the ET-2200 series module.

4.16.1 Set up Mosquitto

Mosquitto is an open-source software application that allows users to create an MQTT Broker and can be installed on Windows, Mac OS, Linux, etc. Alternatively, the user can use an online broker such as broker.emqx.io or broker.hivemq.com.

Step1. Download the Installer (V1.6.4) from the official Mosquitto [website](#) and install the application.

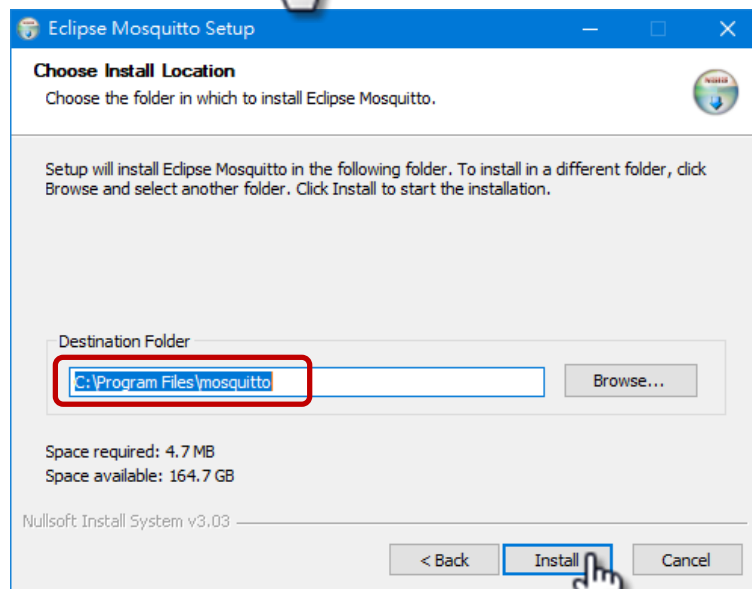
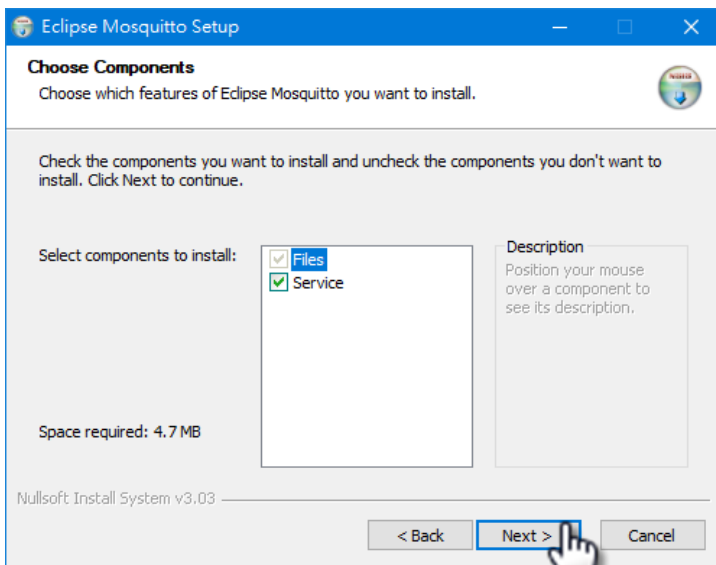

Step2. Locate the “mosquitto.exe” file in the default installation path and double-click it to enable the Mosquitto server.

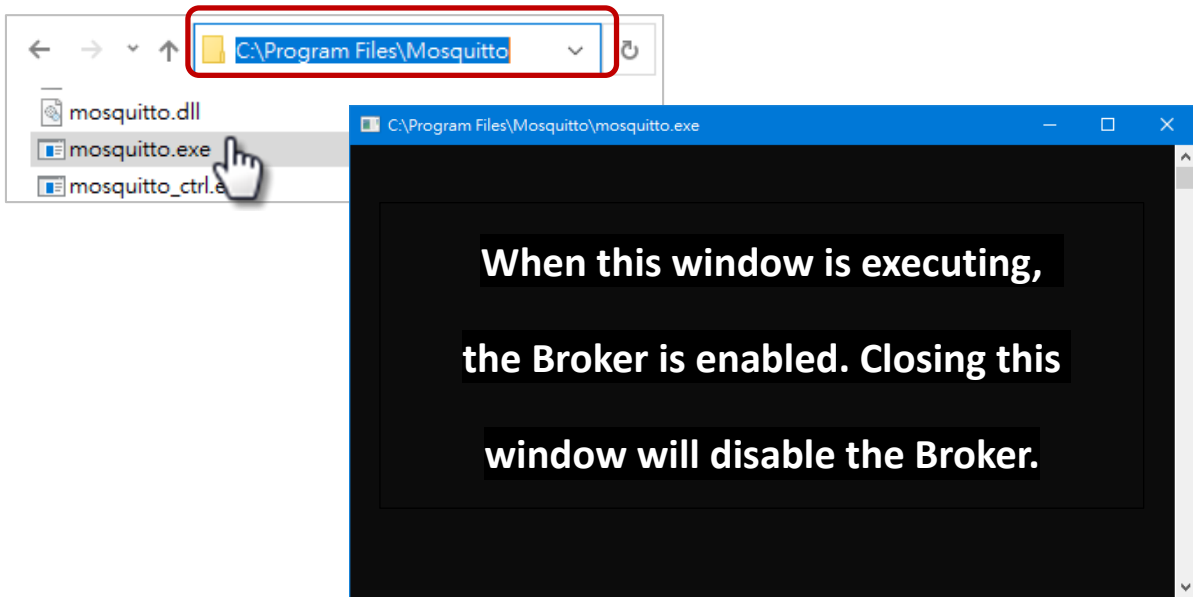

⚠ Why can't I open “mosquitto.exe” or why does it crash?

Once Mosquitto installation is done, the Broker server is automatically activated upon computer boot-up. Thus, if you try to click on the 'mosquitto.exe' file again, it's akin to attempting to enable an already active broker server, which would result in the action being prevented.

To prevent the broker from automatically opening, you can change the settings in the Windows Services application. If it is not necessary to set it, go to Step 3.

Open the Services application by searching for “Services”.

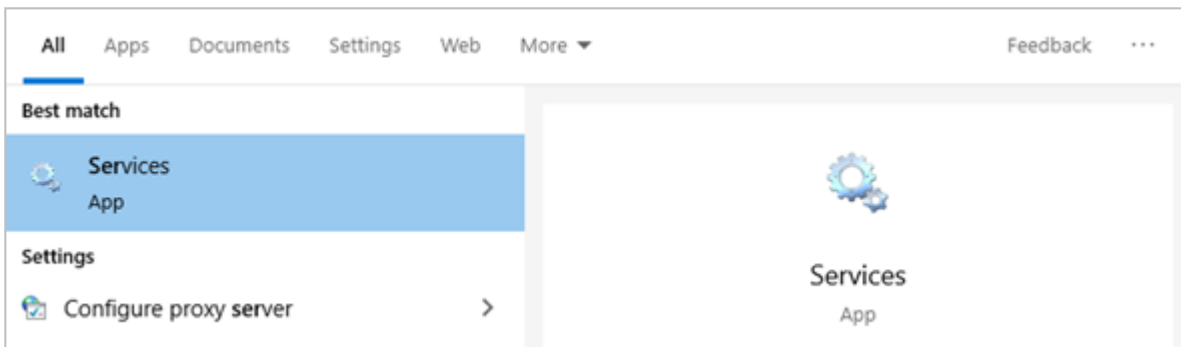

In the **Services** window, locate the "Mosquitto Broker" item and double-click the name to open the **Properties** dialog. Click the **Stop** button and set the **Startup type** to **Manual**. Click **OK** to save your changes.

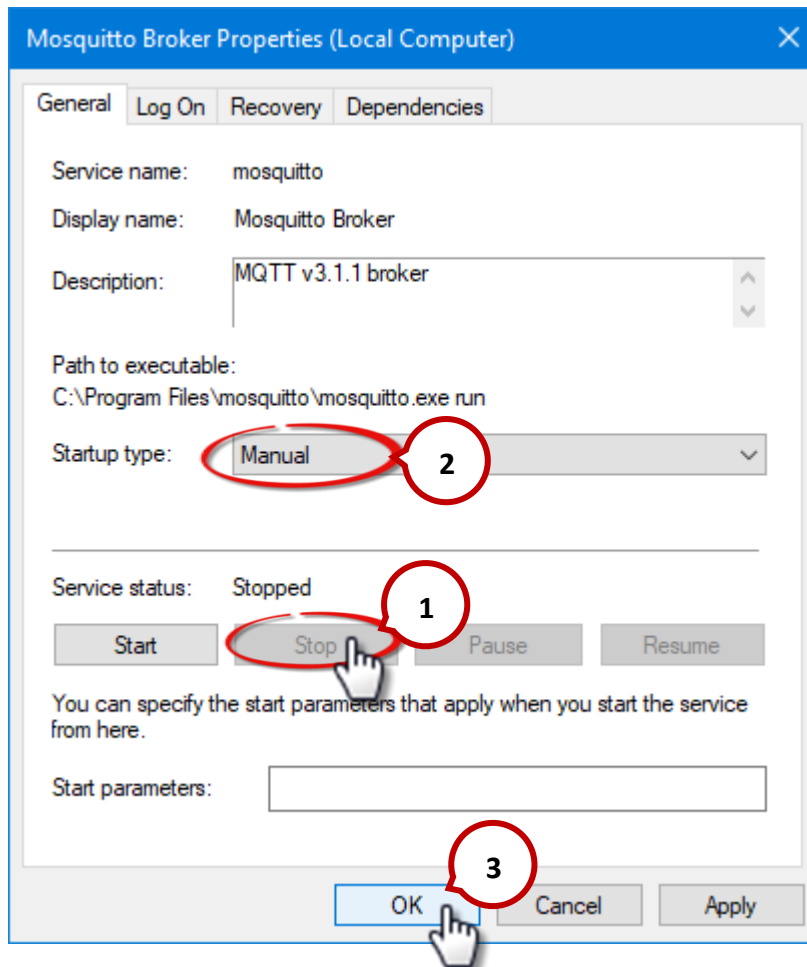
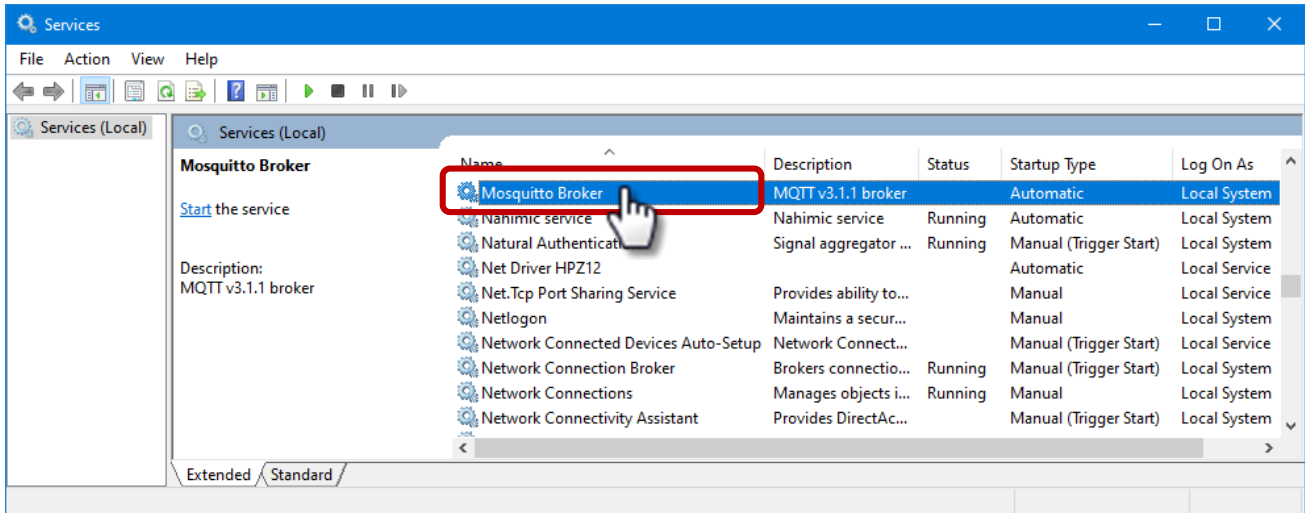

Step3. Open Windows Port 1883 (the default Port for the MQTT)

3.1 Open the **Advanced Settings** section of the Windows Firewall.

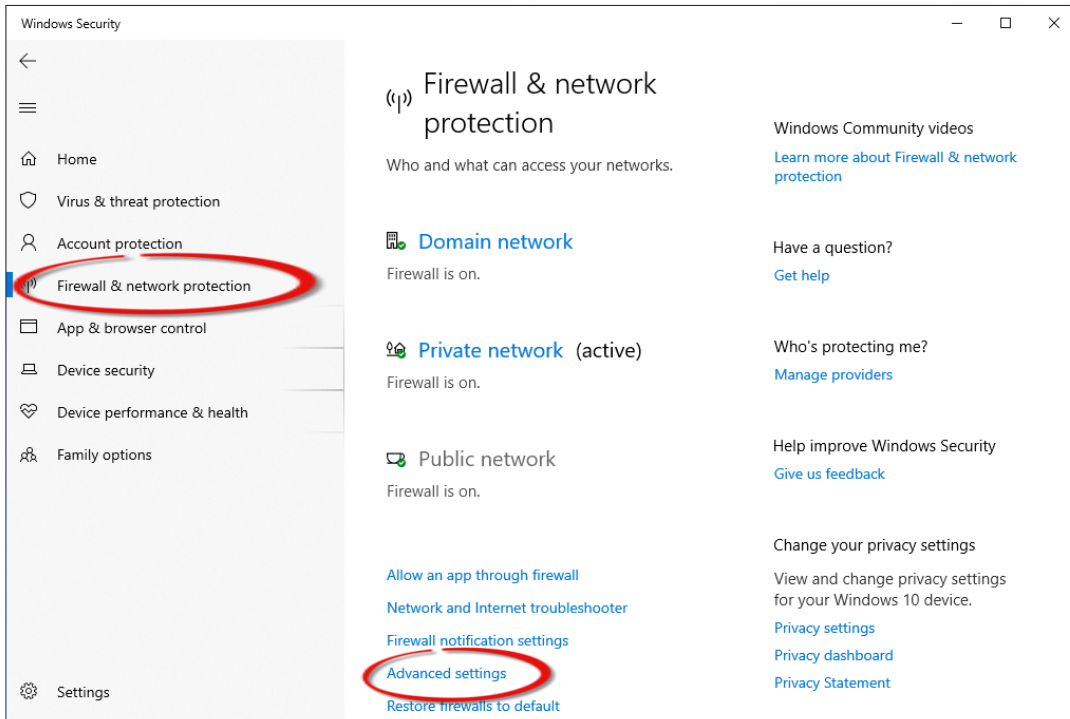

3.2 Add a new rule. Click **Inbound Rules** and **New Rule**, and then select the **Port** option. Click the **Next** button to continue.

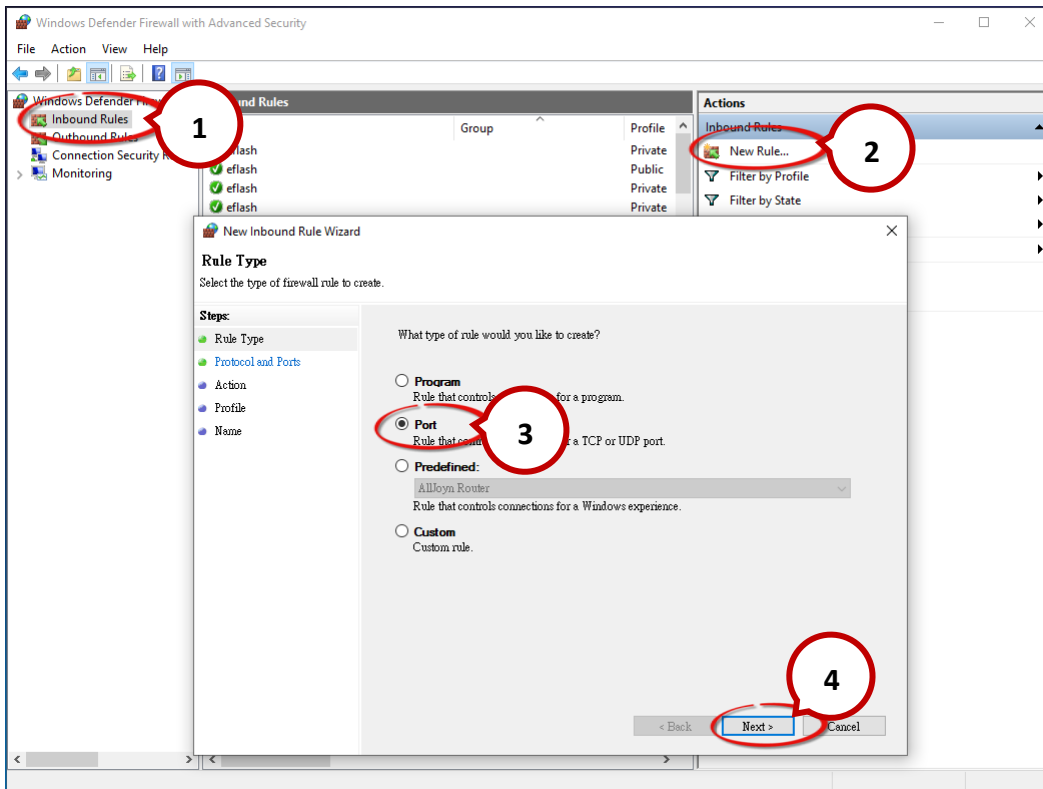

3.3 Select the **TCP** option and then select **Specific local ports** and enter the value **1883**. Click the **Next** button to continue.

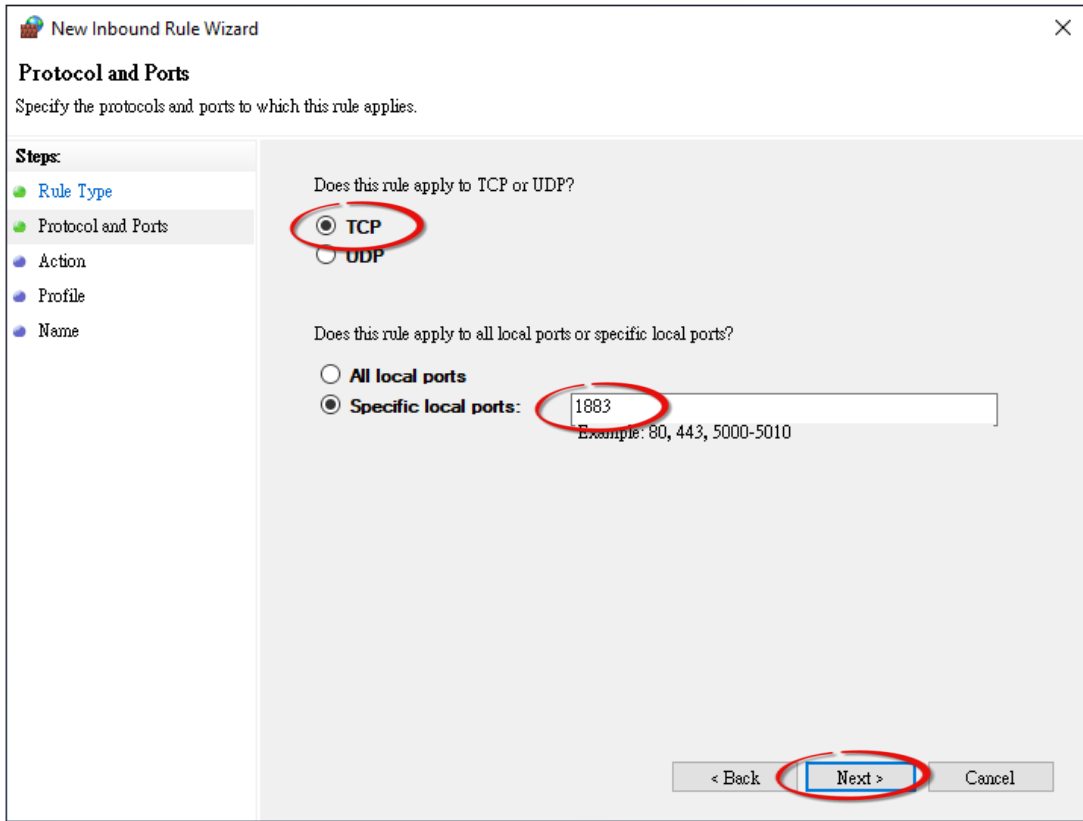

3.4 Select the **Allow the connection** option and then click the **Next** button to continue.

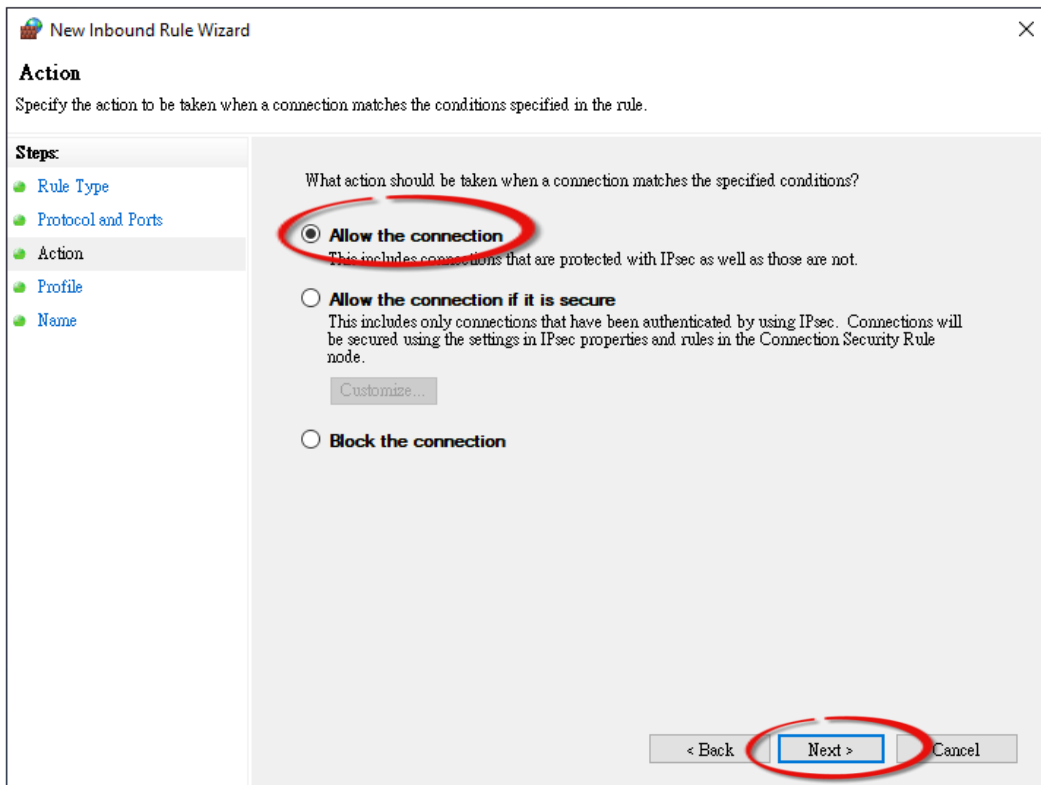

3.5 Select the **Domain** checkbox and click the **Next** button to continue.

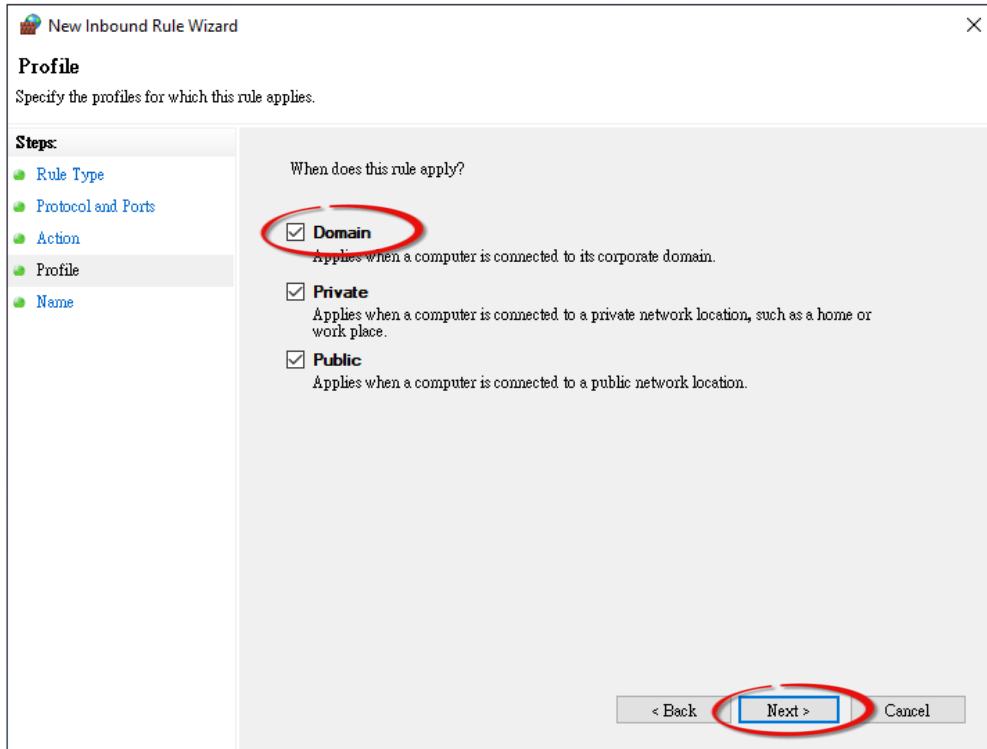

3.6 Enter the name of the rule and then click the **Finish** button to create the rule. Enter the notes if desired.

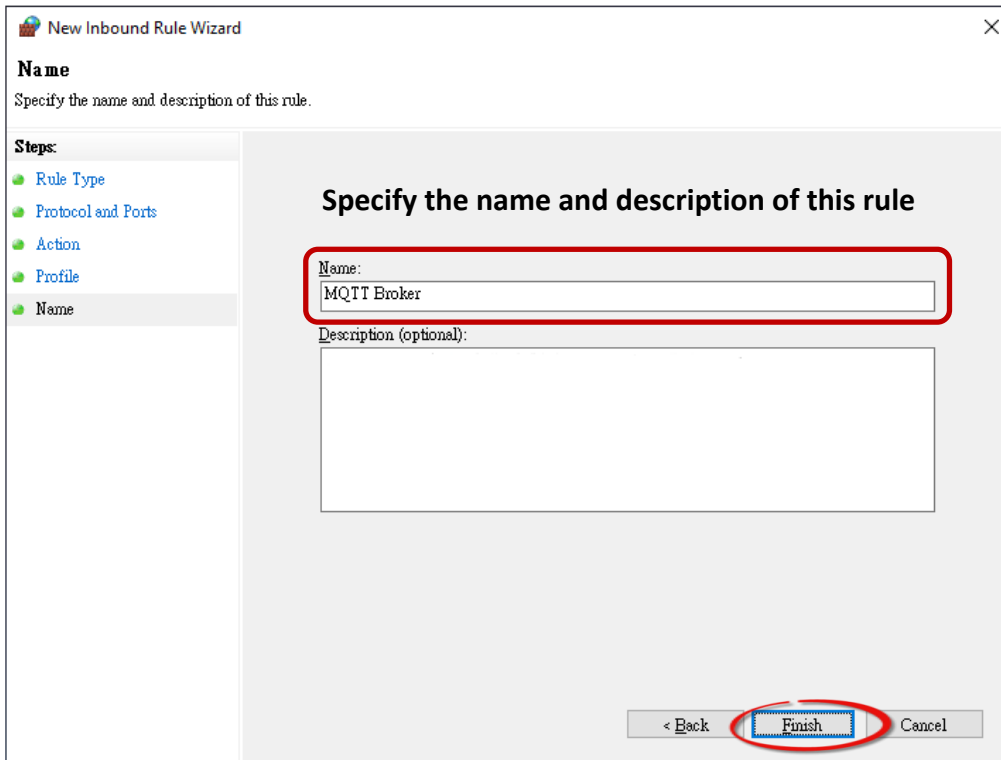

4.16.2 MQTTX Instructions

MQTTX is an open source, cross-platform MQTT 5.0 desktop client originally developed by EMQ, which can run on macOS, Linux and Windows.

Step1. Install MQTTX

Download and execute the installation file (V1.9.4) from the MQTTX website (<https://mqttx.app/>).

Step2. Open MQTTX

After the installation is complete, MQTTX will be automatically opened, and the user can also double-click the shortcut on the desktop to open the software.

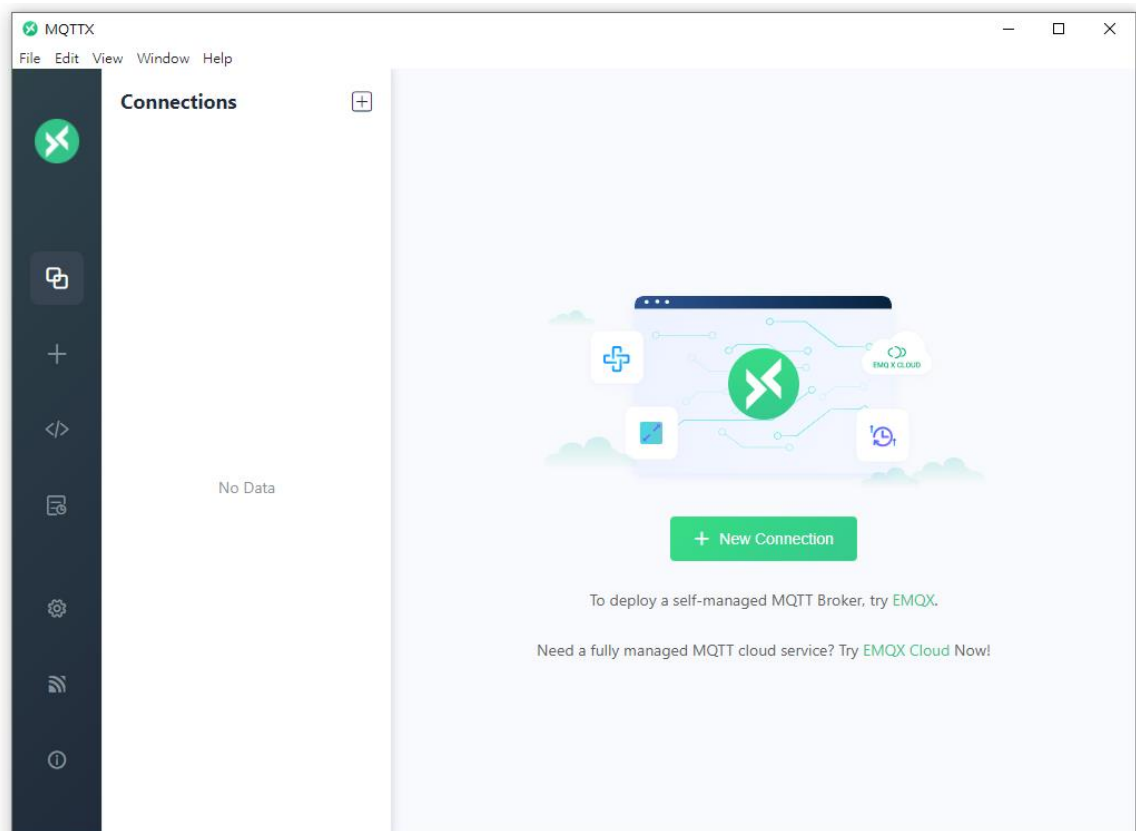

Step3. Establish a connection

1. Click "+" and then click **New Connection** to establish a connection.
2. Enter the Broker name (See Section 4.2.1) and IP address, and click the **Connect** button.

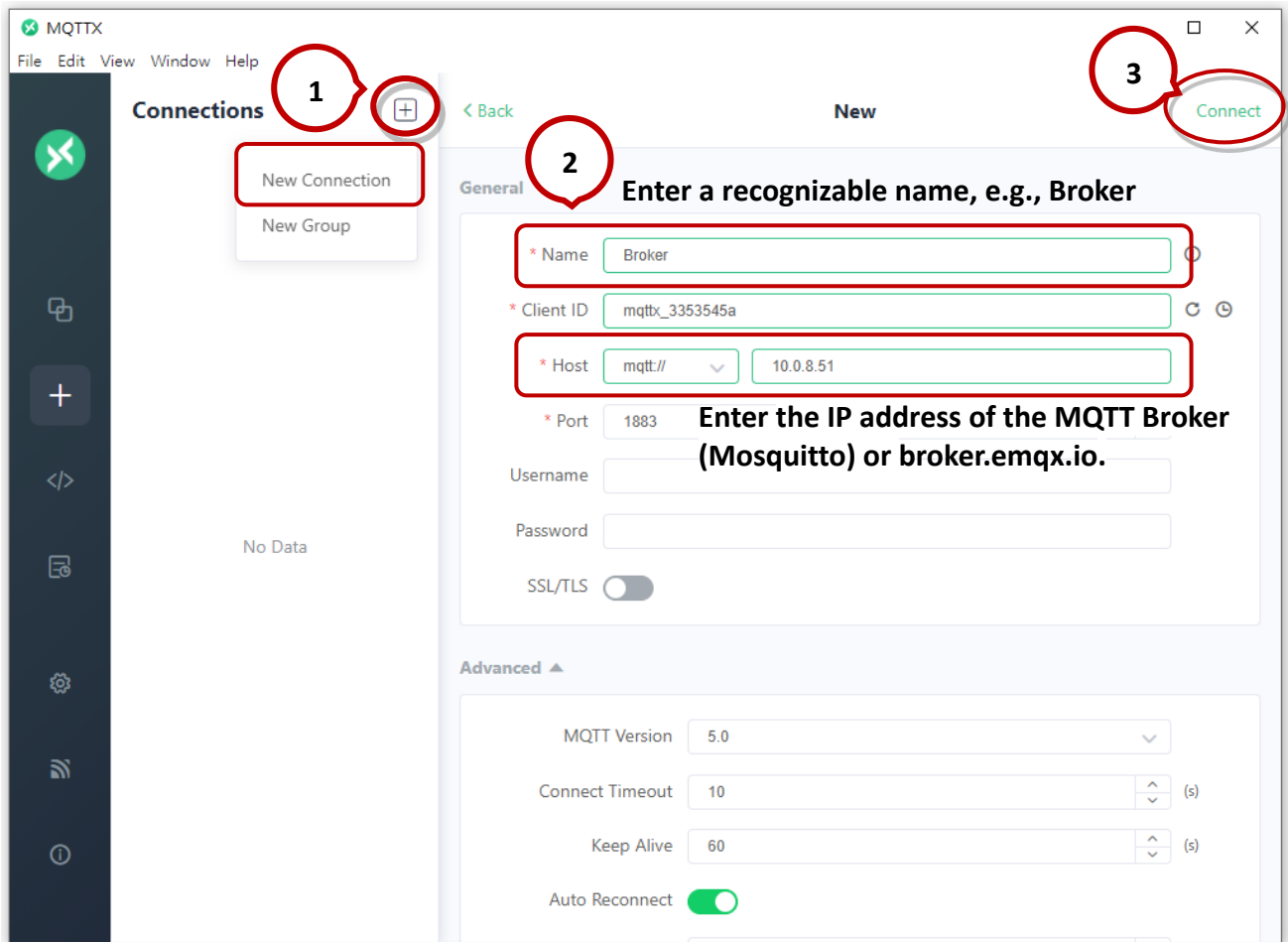

Step4. If the connection is available, the green light will be displayed.

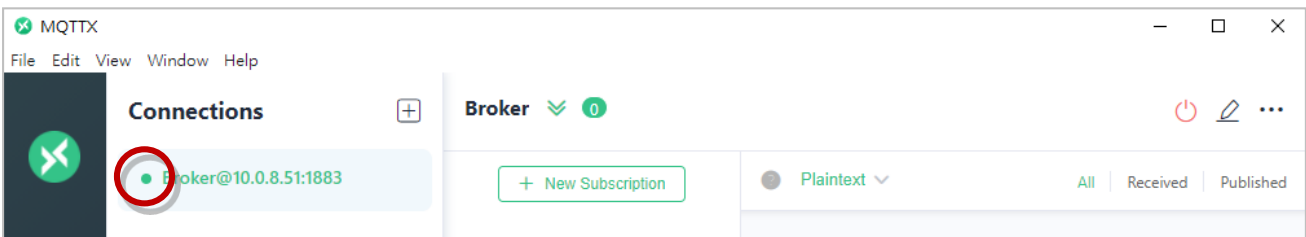

Note: If the connection is unavailable, check to see if the version of the Mosquitto Broker is 1.6.4 (see C:\Program Files\mosquitto\ChangeLog.txt), and refer to [Set up Mosquitto](#) for installation.

4.16.3 MQTT - DO Example

The topic name of MQTT is composed of Main Topic Name (e.g., **ICPDAS/**, refer to [MQTT page](#)) and Sub Topic Name (e.g., **do_all**), which can be set on the **MQTT - DO** page.

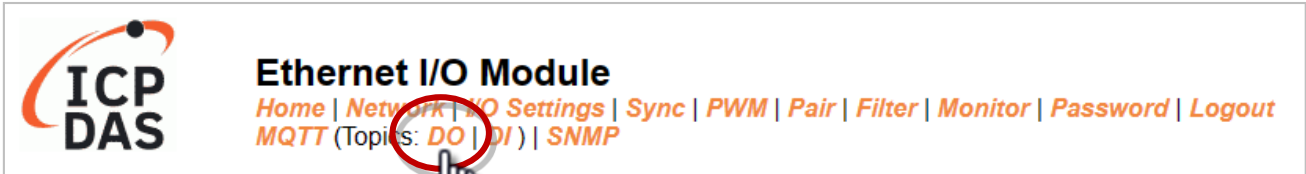

The MQTT – DO page provides the following functions:

Function	Description
Subscribe	Used to subscribe to the topic. The DO statuses can be changed through MQTT messages
Power-on Publish	The DO statuses will be published upon module power-up
State-Change Publish	The DO statuses will be published whenever it changes.
Periodic Publish	The DO statuses will be published periodically, based on the Cycle settings.

(A) MQTT DO – Subscribe

Users can choose to enable/disable single-channel (DO0, DO1, etc.) or multi-channel (ALL) for topics operations. It is recommended to use multi-channel operations to reduce network traffic and to disable unused topics to reduce unnecessary processing and improve operational efficiency.

6)

Step1. Log in to the module's Web Server, and click the **Subscribe** option for the “do_all” on the MQTT - "DO" page to enable the function. After that, click **Update** to save the changes.

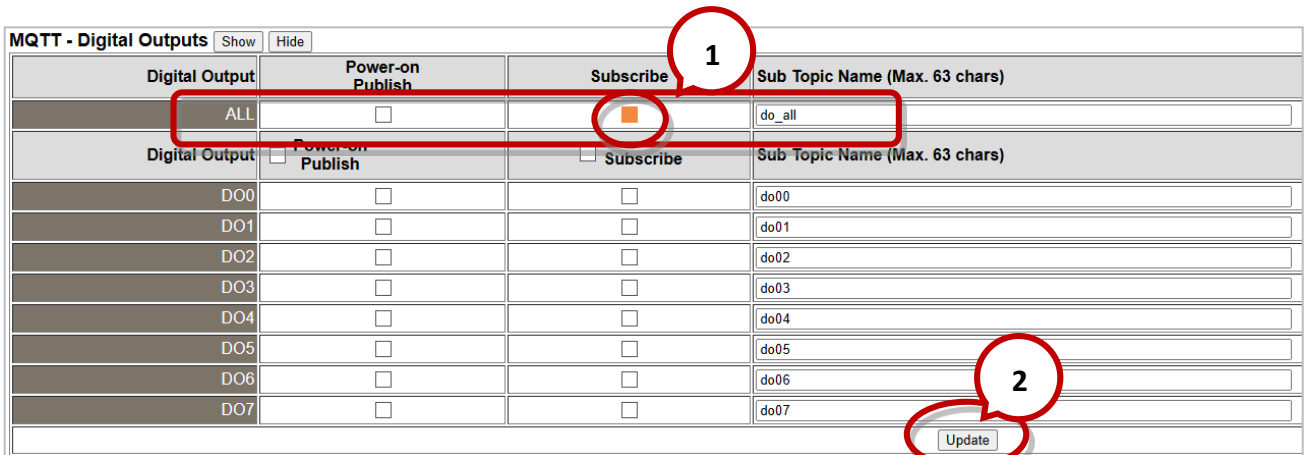

Step2. Make sure that the MQTT function has been enabled on the **MQTT** page, and the Broker's IP address and the Main Topic Name have been set.

Connectivity Settings

MQTT	Enable <input type="button" value="v"/>
Broker	IPv4 / Host Name (Max. 127 chars) 10.0.8.51
Broker Port	1883 (Default= 1883)
Client Identifier	tPET-P2R2_RevB_65FA7F
User Name	(Max. 63 chars)
Password	(Max. 63 chars)
Reconnection Interval	10 (5 ~ 65000 s, Default= 10)
Keep Alive Interval	20 (5 ~ 65000 s, Default= 20)
Main Topic Name	ICPDAS/ (Max. 126 chars)
<input type="button" value="Update Settings"/>	

Step3. Enter the message (e.g., 0xF) to be published for the "ICPDAS/do_all" topic, and click the button on the right corner to send the message.

The screenshot shows the MQTT interface with the following elements:

- 1:** Topic name: ICPDAS/do_all
- 2:** Payload: 0xF
- 3:** Published message: Topic: ICPDAS/do_all QoS: 0, 0xF, 2023-07-25 16:29:38:513

Step4. The user can check whether the DO status is correct on the Home page.

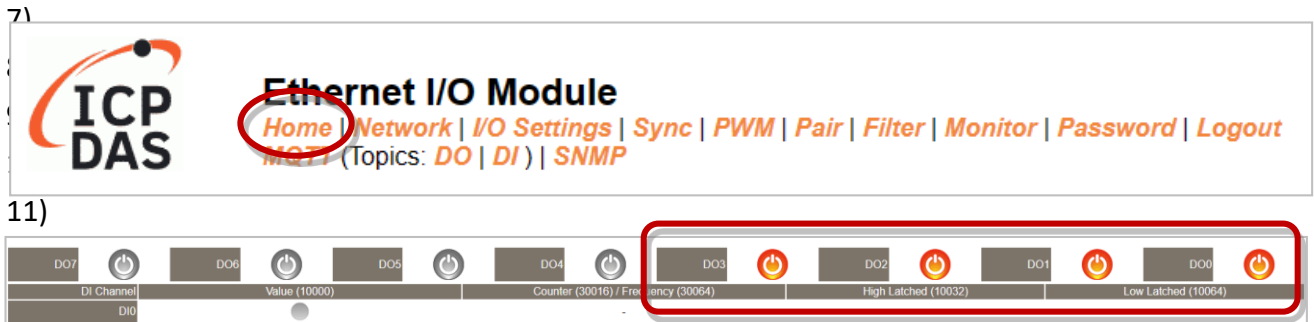

The message "0x0" indicates DO 0-3 = ON, DO 4-7 = OFF

(B) MQTT DO – Power on Publish

Step1. Make sure that the Mosquitto Broker is enabled and the MQTTX is connected. In this example, the topic is "ICPDAS/do_all". Refer to "Set up Mosquitto" and "MQTTX Instructions".

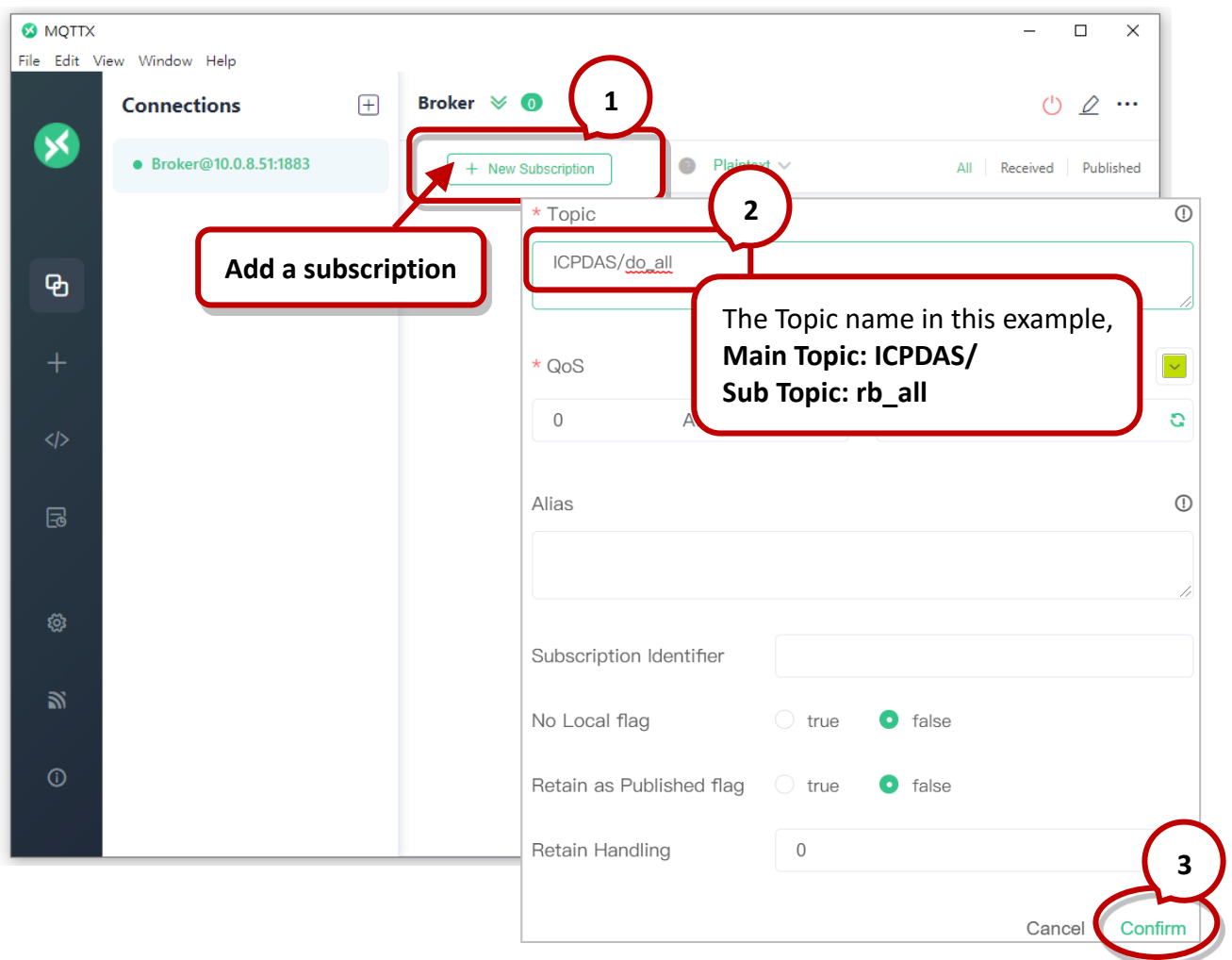

Step2. Log in to the module's Web Server, and click the **Power-on Publish** option for the "do_all" on the MQTT - "DO" page to enable the function. After that, click **Update** to save the changes.

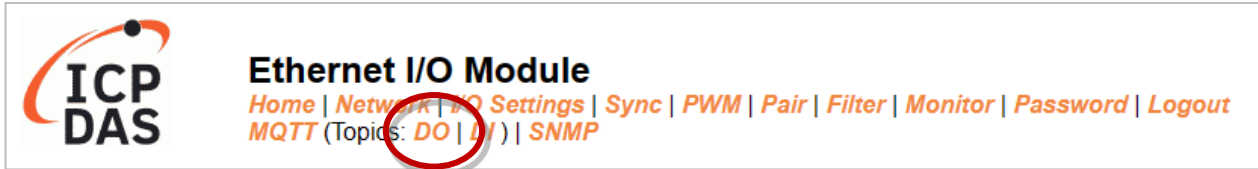

MQTT - Digital Outputs

Digital Output	Power-on Publish	Subscribe	Sub Topic Name (Max. 63 chars)
ALL	<input checked="" type="checkbox"/>	<input type="checkbox"/>	do_all
Digital Output	Power-on Publish	Subscribe	Sub Topic Name (Max. 63 chars)
DO0	<input type="checkbox"/>	<input type="checkbox"/>	do00
DO1	<input type="checkbox"/>	<input type="checkbox"/>	do01
DO2	<input type="checkbox"/>	<input type="checkbox"/>	do02
DO3	<input type="checkbox"/>	<input type="checkbox"/>	do03
DO4	<input type="checkbox"/>	<input type="checkbox"/>	do04
DO5	<input type="checkbox"/>	<input type="checkbox"/>	do05
DO6	<input type="checkbox"/>	<input type="checkbox"/>	do06
DO7	<input type="checkbox"/>	<input type="checkbox"/>	do07

Step3. On the I/O Settings page, set the DO power-on value, and then click Update Setting to update the settings.

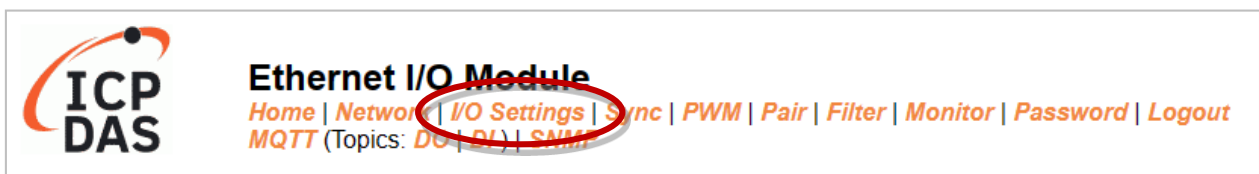

DI/DO Configuration:

Digital Output	Modbus Address	
Host/Slave Watchdog Timeout	40257	0 (10 ~ 65000 Seconds, Default= 0, Disable= 0) Outputs DO with safe-value or <i>PWM</i> when host/slave timeout.
Enable Safe Value (Enable Watchdog)	00339 - 00332	0x0 (CH 7 - 0: <input type="checkbox"/> <input type="checkbox"/> <input type="checkbox"/> <input type="checkbox"/> <input type="checkbox"/> <input type="checkbox"/> <input type="checkbox"/>)
Safe Value	00274 - 00267	0x0 (CH 7 - 0: <input type="checkbox"/> <input type="checkbox"/> <input type="checkbox"/> <input type="checkbox"/> <input type="checkbox"/> <input type="checkbox"/> <input type="checkbox"/>)
Power-On Value	00242 - 00235	0x3 (CH 7 - 0: <input type="checkbox"/> <input type="checkbox"/> <input type="checkbox"/> <input type="checkbox"/> <input type="checkbox"/> <input checked="" type="checkbox"/> <input checked="" type="checkbox"/>)

The DO0, DO1 will be set to ON when the module starts.

Step4. After the module boots, the DO value will be set to the predefined power-on value.

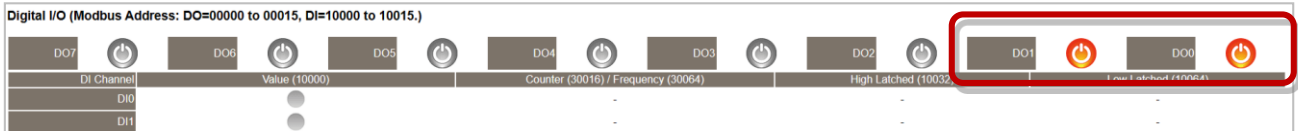
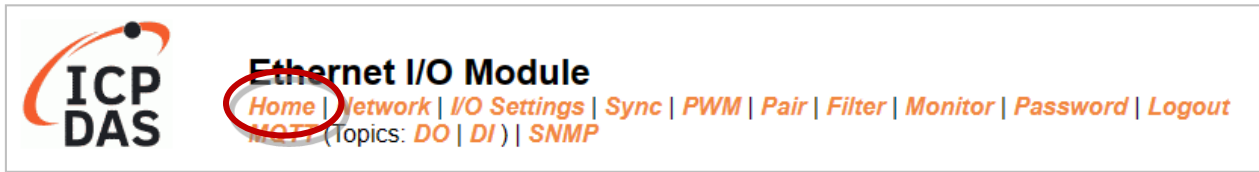

The DO0, DO1 will be set to ON after rebooting the module.

In addition, users can check the received DO values in MQTTX.

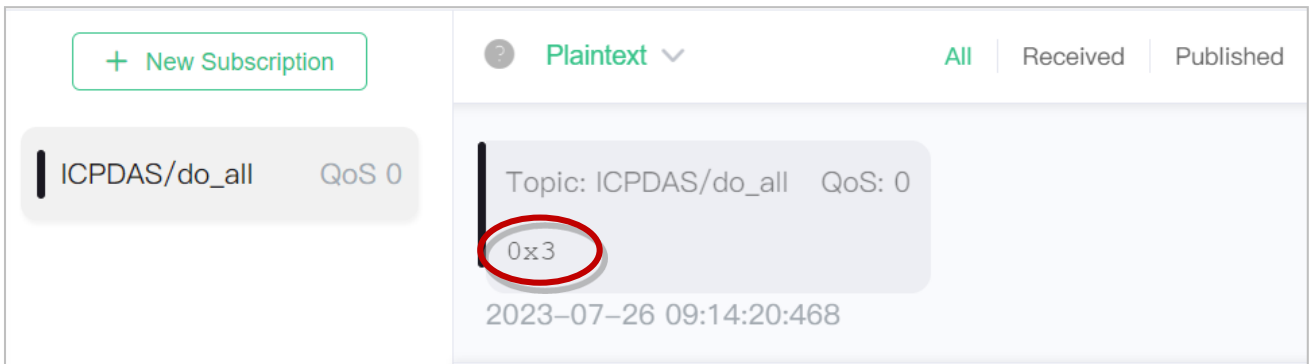

“0x3” indicates DO0 to DO1 are “ON” and the others are “OFF”

(C) MQTT DO – State Change Publish

Step1. Make sure that the Mosquitto Broker is enabled and the MQTTX is connected. In this example, the topic is "ICPDAS/rb_all". Refer to "Set up Mosquitto" and "MQTTX Instructions".

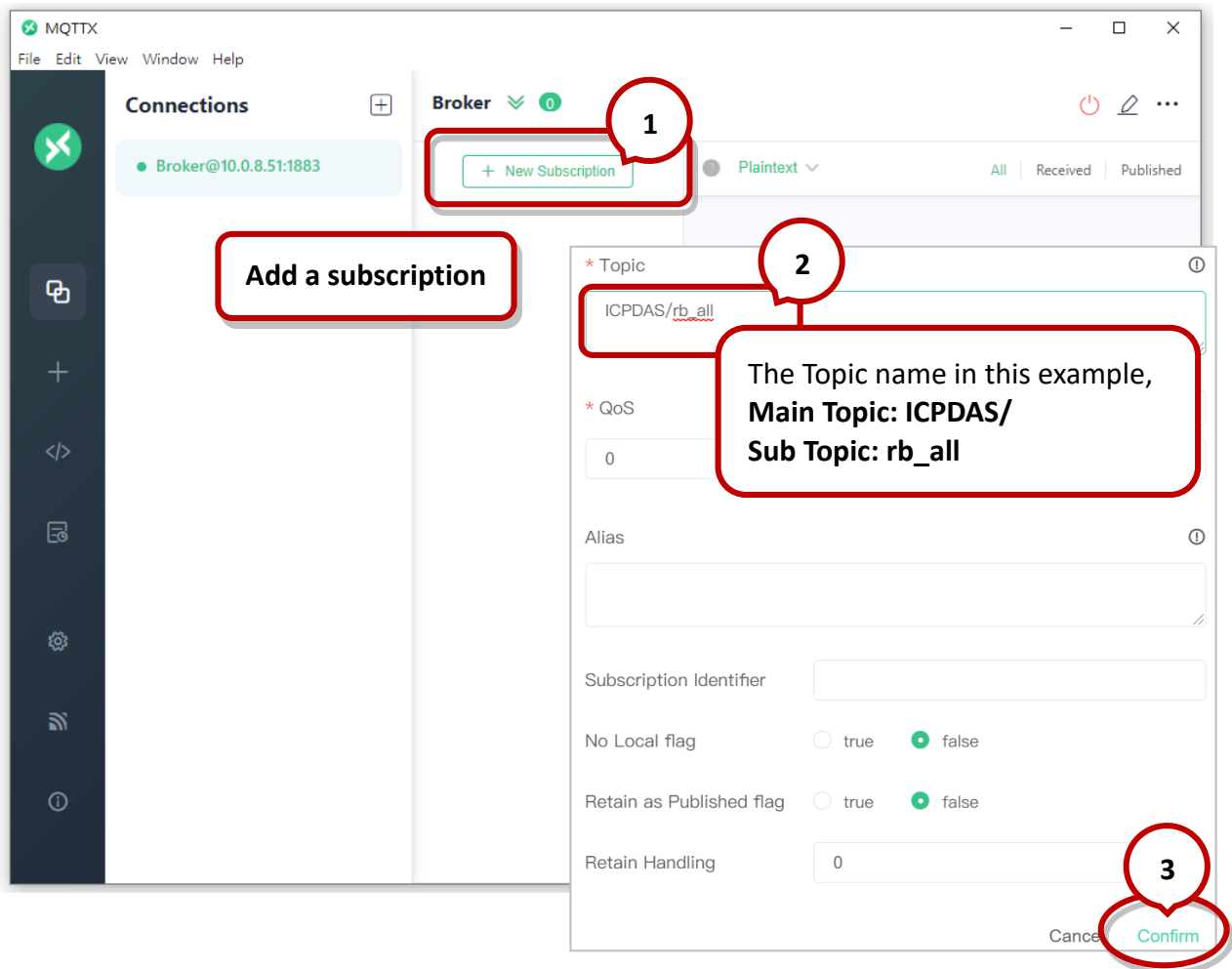

Step2. Log in to the module's Web Server, and click the **State-Change Publish** option for the "rb_all" on the MQTT - "DO" page to enable the function. After that, click Update to save the changes.

Readbacks of the Digital Outputs Show Hide			
Readback	State-Change Publish	Periodic Publish	Sub Topic Name (Max. 63 chars)
ALL	<input checked="" type="checkbox"/>	<input type="checkbox"/>	rb_all
Readback	State-Change Publish	Periodic Publish	Sub Topic Name (Max. 63 chars)
DO0	<input type="checkbox"/>	<input type="checkbox"/>	rb00
DO1	<input type="checkbox"/>	<input type="checkbox"/>	rb01
DO2	<input type="checkbox"/>	<input type="checkbox"/>	rb02
DO3	<input type="checkbox"/>	<input type="checkbox"/>	rb03
DO4	<input type="checkbox"/>	<input type="checkbox"/>	rb04
DO5	<input type="checkbox"/>	<input type="checkbox"/>	rb05
DO6	<input type="checkbox"/>	<input type="checkbox"/>	rb06
DO7	<input type="checkbox"/>	<input type="checkbox"/>	rb07

Step3. On the **Home** page, set the DO0 to DO2 to “ON” in sequence.

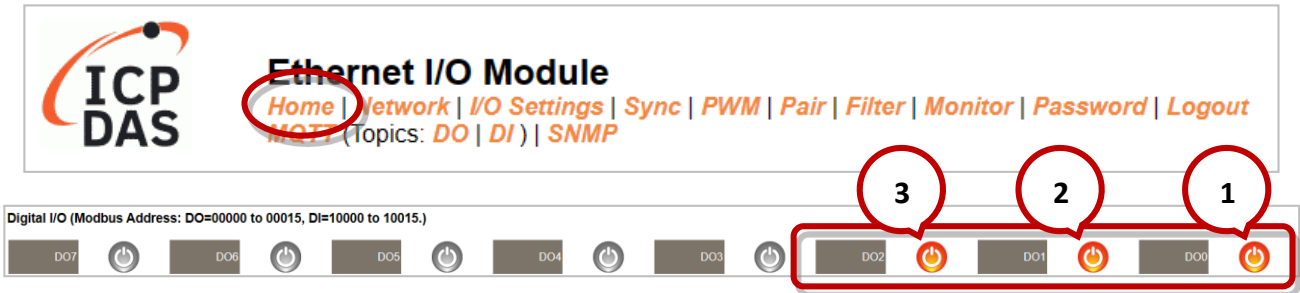

Step4. The user can view the received messages within the MQTTX window.

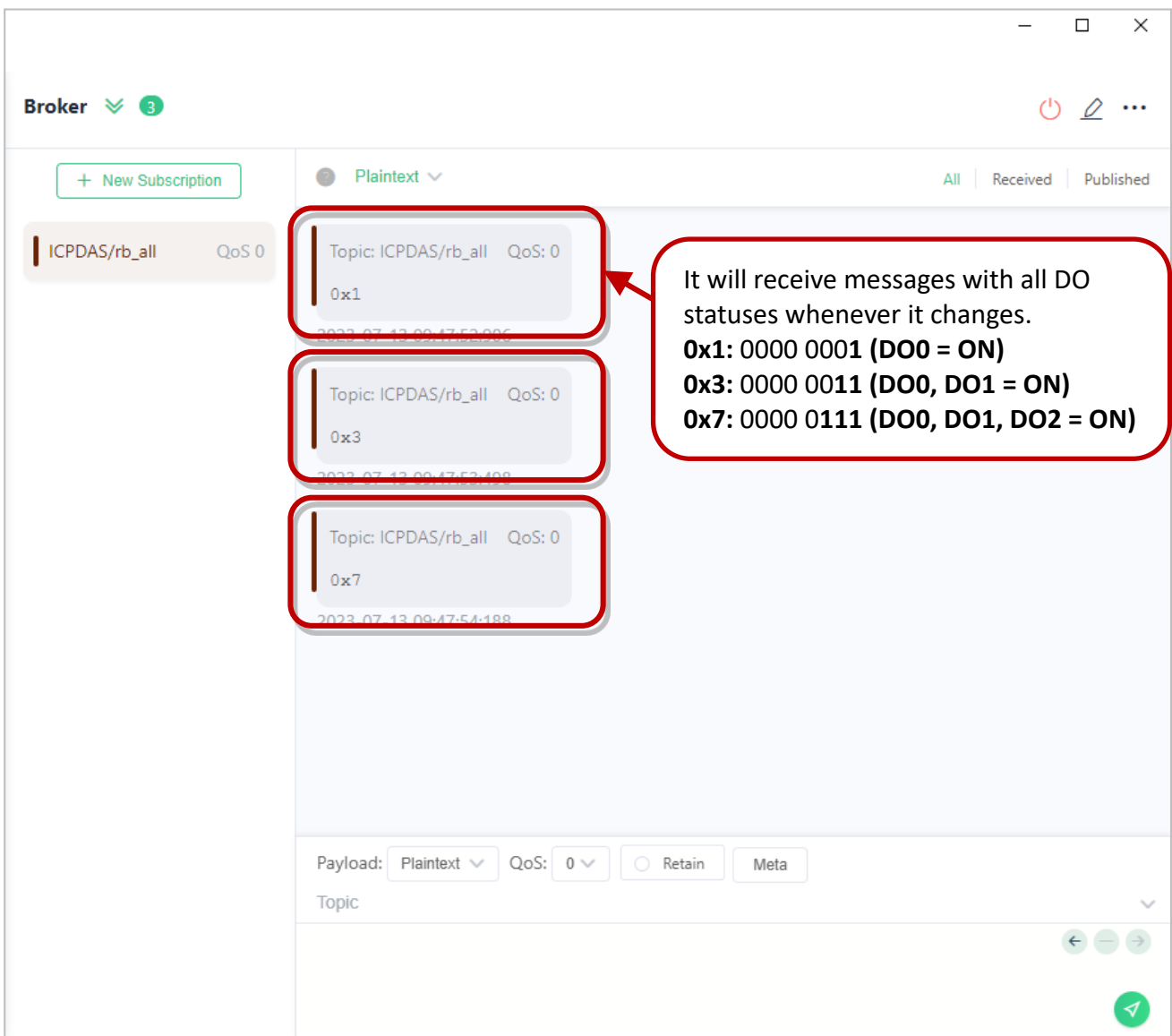

(D) MQTT DO – Periodic Publish

Step1. Make sure that the Mosquitto Broker is enabled and the MQTTX is connected. In this example, the topic is "ICPDAS/rb_all ". Refer to "Set up Mosquitto" and "MQTTX Instructions".

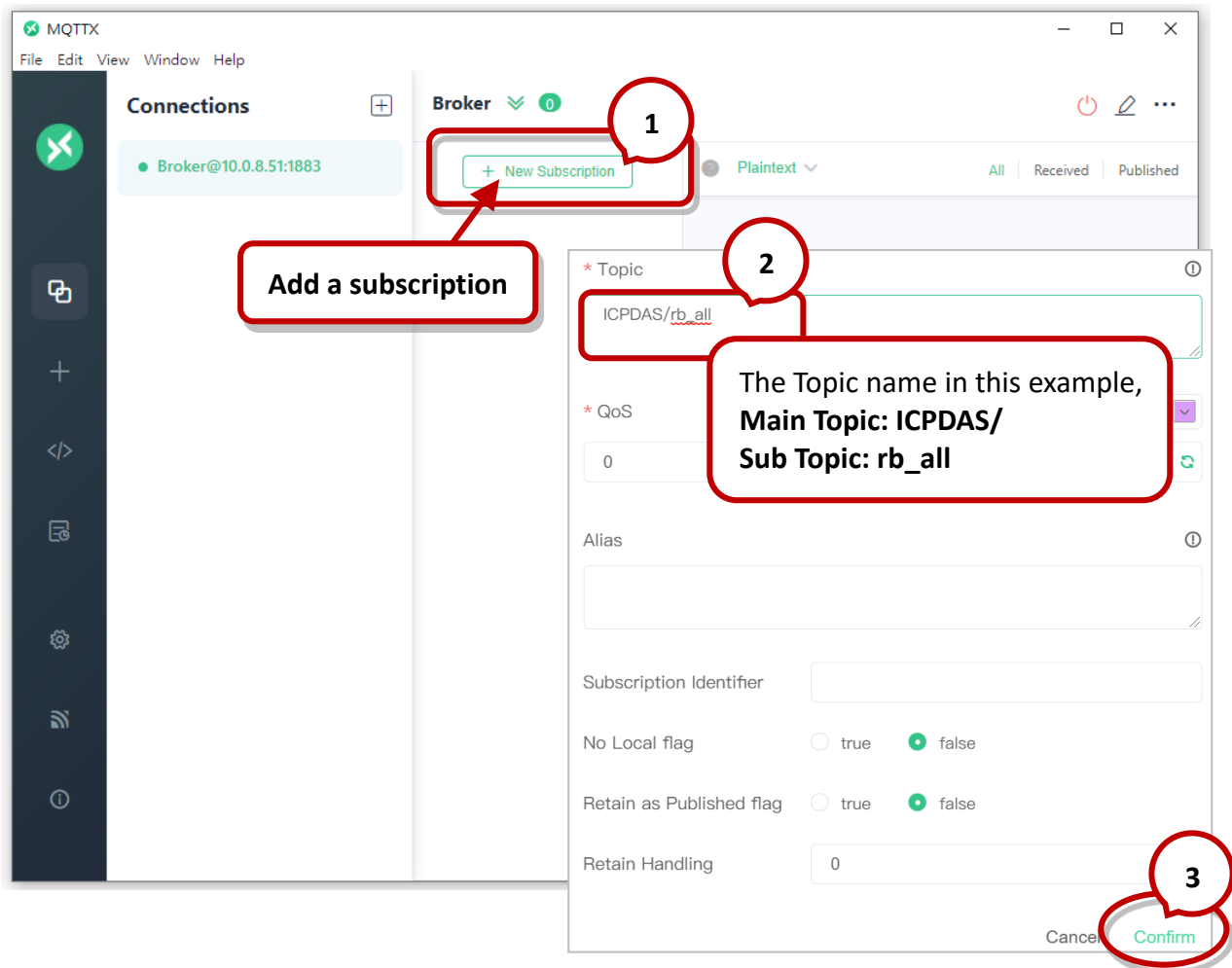

Step2. Log in to the module's Web Server, and click the **Periodic Publish** option for the "rb_all" on the MQTT - "DO" page to enable the function. After that, click **Update** to save the changes.

Readbacks of the Digital Outputs Show Hide

Readback	State-Change Publish	Periodic Publish	Sub Topic Name (Max. 63 chars)
ALL	<input type="checkbox"/>	<input checked="" type="checkbox"/>	rb_all
Readback	<input type="checkbox"/> State-Change Publish	<input type="checkbox"/> Periodic Publish	Sub Topic Name (Max. 63 chars)
DO0	<input type="checkbox"/>	<input type="checkbox"/>	rb00
DO1	<input type="checkbox"/>	<input type="checkbox"/>	rb01
DO2	<input type="checkbox"/>	<input type="checkbox"/>	rb02
DO3	<input type="checkbox"/>	<input type="checkbox"/>	rb03
DO4	<input type="checkbox"/>	<input type="checkbox"/>	rb04
DO5	<input type="checkbox"/>	<input type="checkbox"/>	rb05
DO6	<input type="checkbox"/>	<input type="checkbox"/>	rb06
DO7	<input type="checkbox"/>	<input type="checkbox"/>	rb07

Update

Step3. Go to the **MQTT** page, set the message publishing cycle (Cycle), and click "**Update Setting**" to save the changes.

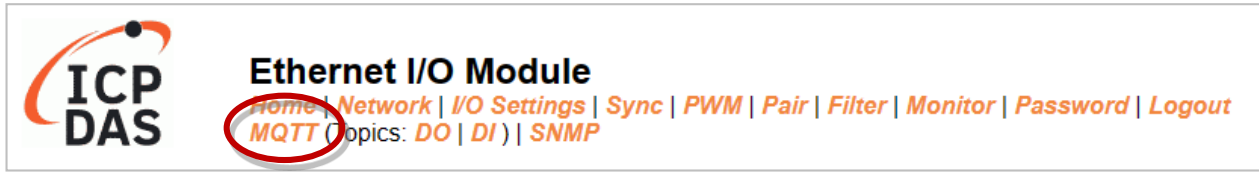

Publication Settings

Publication	
Retain	<input type="checkbox"/>
Cycle	9000 (100 ~ 2147483000 ms, in 10 ms step, Default= 9000)
All Information	
Enable	Disable ▾
Sub Topic Name	info (Max. 63 chars)
Last Will and Testament	
Enable	<input type="checkbox"/>
Retain	<input type="checkbox"/>
QoS	0 - At most once ▾
Topic	N/A (Max. 63 chars)
Message	N/A (Max. 63 chars)
Update Settings	

Step4. The user can view the received messages within the MQTTX window.

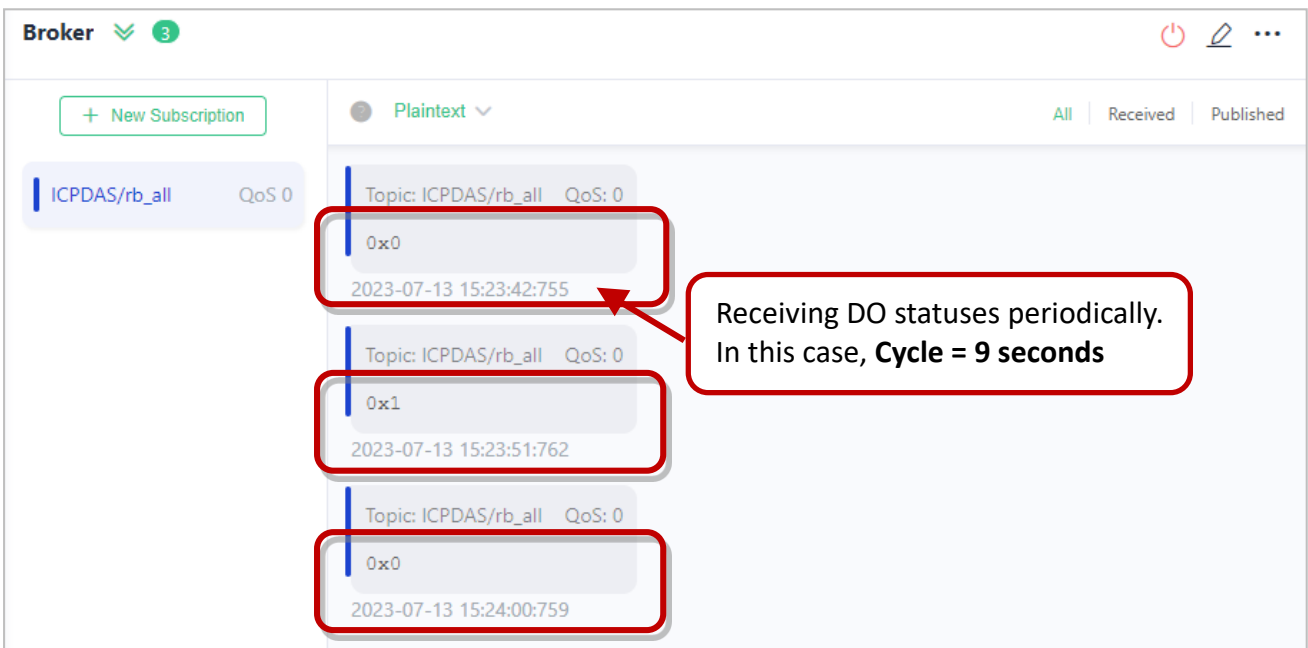

4.16.4 MQTT - DI Example

The topic name of MQTT is composed of Main Topic Name (e.g., ICPDAS/, refer to [MQTT page](#)) and Sub Topic Name (e.g., di_all), which can be set on the **MQTT - DI** page.

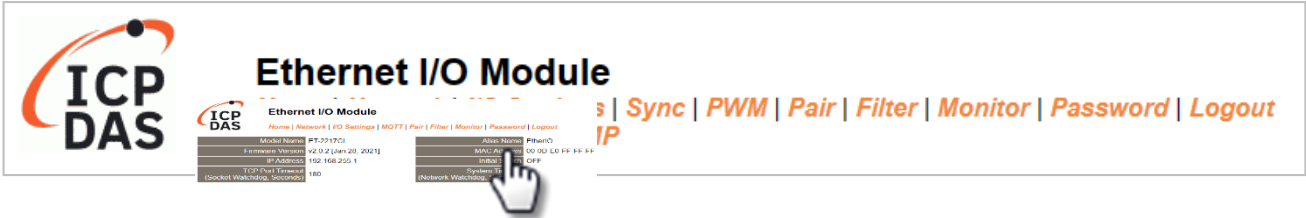

The MQTT – DI page provides the following functions:

Function	Description
State-Change Publish	The message will be published when the DI state changes.
Periodic Publish	The DI status is published periodically, and the release cycle is determined by the Cycle setting.

(A) MQTT DI – State Change Publish

Users can choose to enable/disable single-channel (DIO, DI1, etc.) or multi-channel (ALL) for topics operations. It is recommended to use multi-channel operations to reduce network traffic and to disable unused topics to reduce unnecessary processing and improve operational efficiency.

Step1. On the MQTT - DI page, click the **State-Change Publish** for the “di_all” to enable this function. After that, click **Update** to save the changes.

MQTT - Digital Inputs

Digital Input	State-Change Publish	Periodic Publish	Sub Topic Name (Max. 63 chars)
ALL	<input checked="" type="checkbox"/>	<input type="checkbox"/>	di_all
Digital Input	State-Change Publish	Periodic Publish	Sub Topic Name (Max. 63 chars)
DIO	<input type="checkbox"/>	<input type="checkbox"/>	di00
DI1	<input type="checkbox"/>	<input type="checkbox"/>	di01
DI2	<input type="checkbox"/>	<input type="checkbox"/>	di02
DI3	<input type="checkbox"/>	<input type="checkbox"/>	di03
DI4	<input type="checkbox"/>	<input type="checkbox"/>	di04
DI5	<input type="checkbox"/>	<input type="checkbox"/>	di05
DI6	<input type="checkbox"/>	<input type="checkbox"/>	di06
DI7	<input type="checkbox"/>	<input type="checkbox"/>	di07

Step2. Make sure that the Mosquitto Broker is enabled and the MQTTX is connected. In this example, the topic is "ICPDAS/di_all". Refer to "[Set up Mosquitto](#)" and "[MQTTX Instructions](#)".

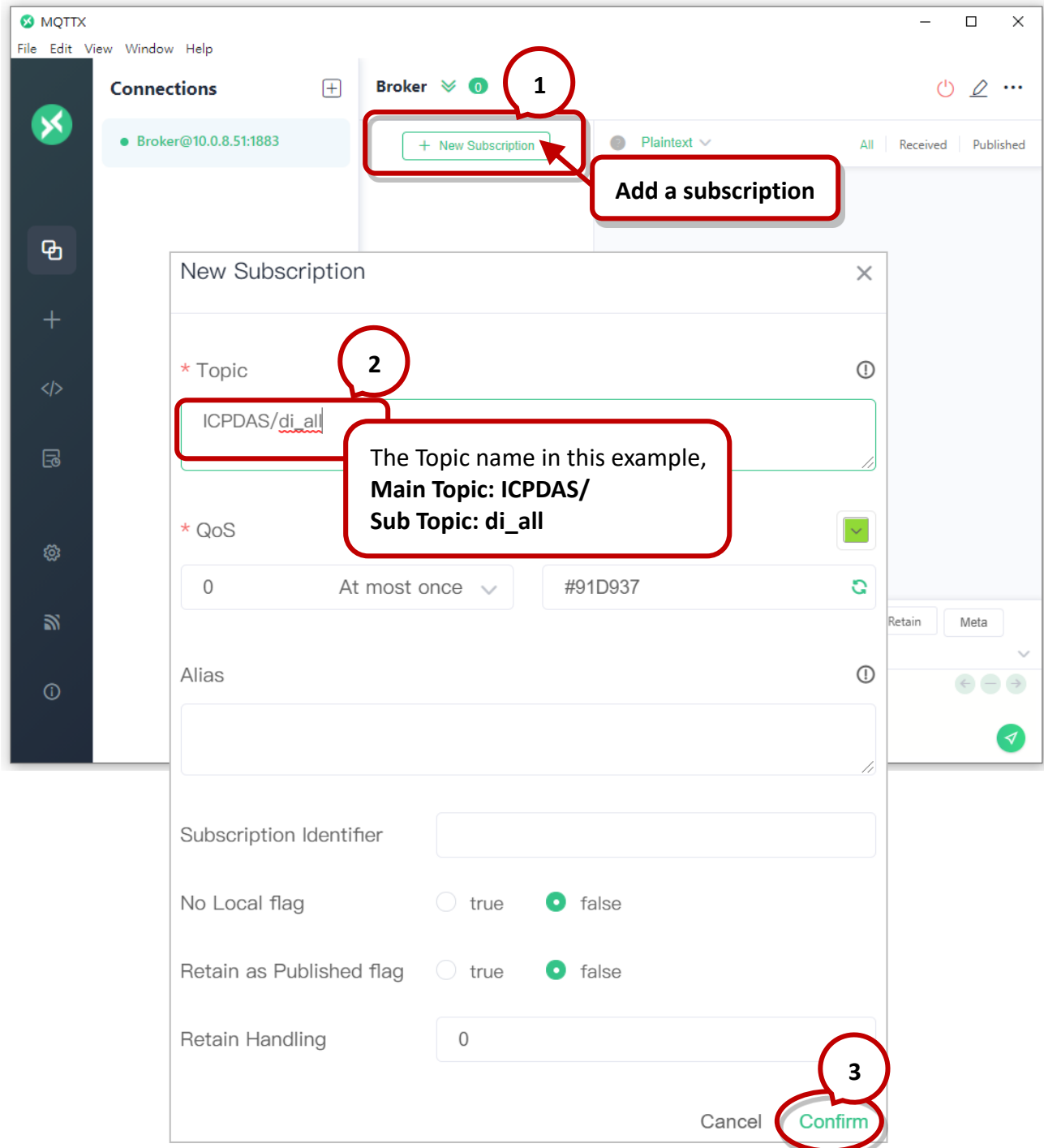

Step3. When the external signal changes, it will also change the DI status, and the module will send an MQTT message. For testing purposes, the user can consult the ET-2200 series Quick Start guide for wiring the I/O.

<https://www.icpdas.com/en/download/show.php?num=2628>

3 Wiring the DI and DO for Self-test

- 1) Connect the **NO0 pin (Pin01)** to the **GND pin (Pin02)**.
- 2) Connect the **COM0 pin (Pin03)** to the **DI0 pin (Pin04)**.

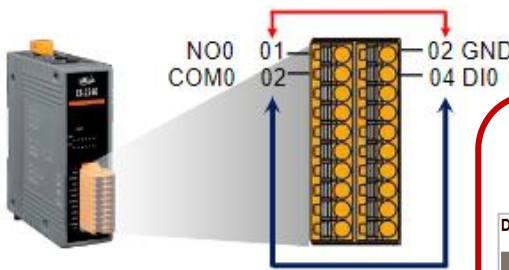

(P)ET-2260:
When DO0 is set to 'ON', the DI0 becomes ON

Digital I/O (Modbus Address: DO=00000 to 00015, DI=10000 to 10015.)				
DI Channel	Value (10000)	Counter (30016) / Frequency (30064)	High Latched (10032)	Low Latched (10064)
DI0	●	-	-	-
DI1	●	-	-	-
DI2	●	-	-	-

Step4. The user can view the received messages within the MQTTX window.

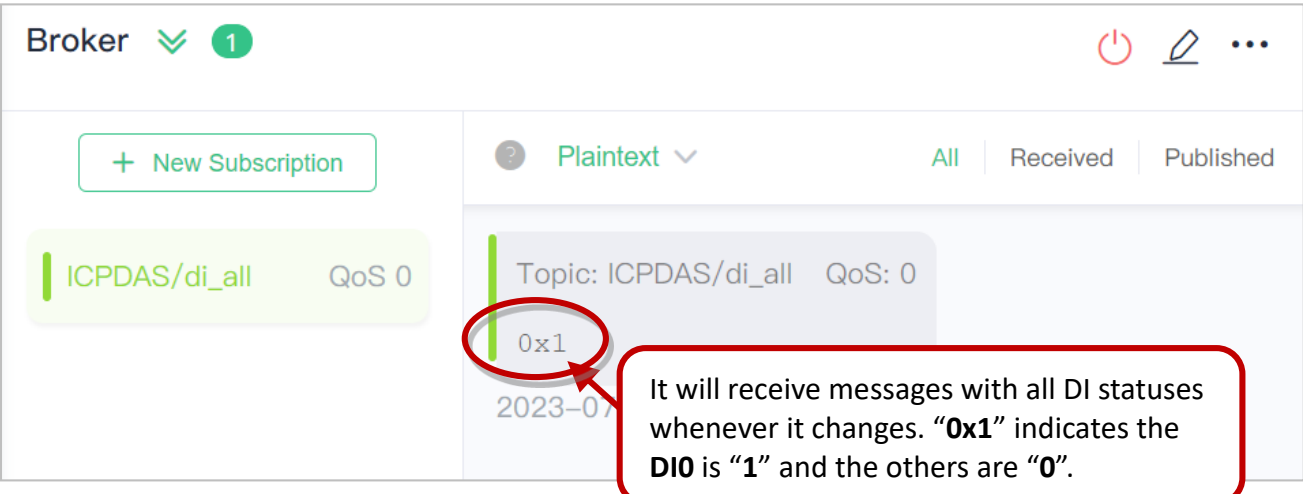

It will receive messages with all DI statuses whenever it changes. "0x1" indicates the **DI0** is "1" and the others are "0".

(B) MQTT DI – Periodic Publish

Step1. Make sure that the Mosquitto Broker is enabled and the MQTTX is connected. In this example, the topic is "ICPDAS/di_all". Refer to "[Set up Mosquitto](#)" and "[MQTTX Instructions](#)".

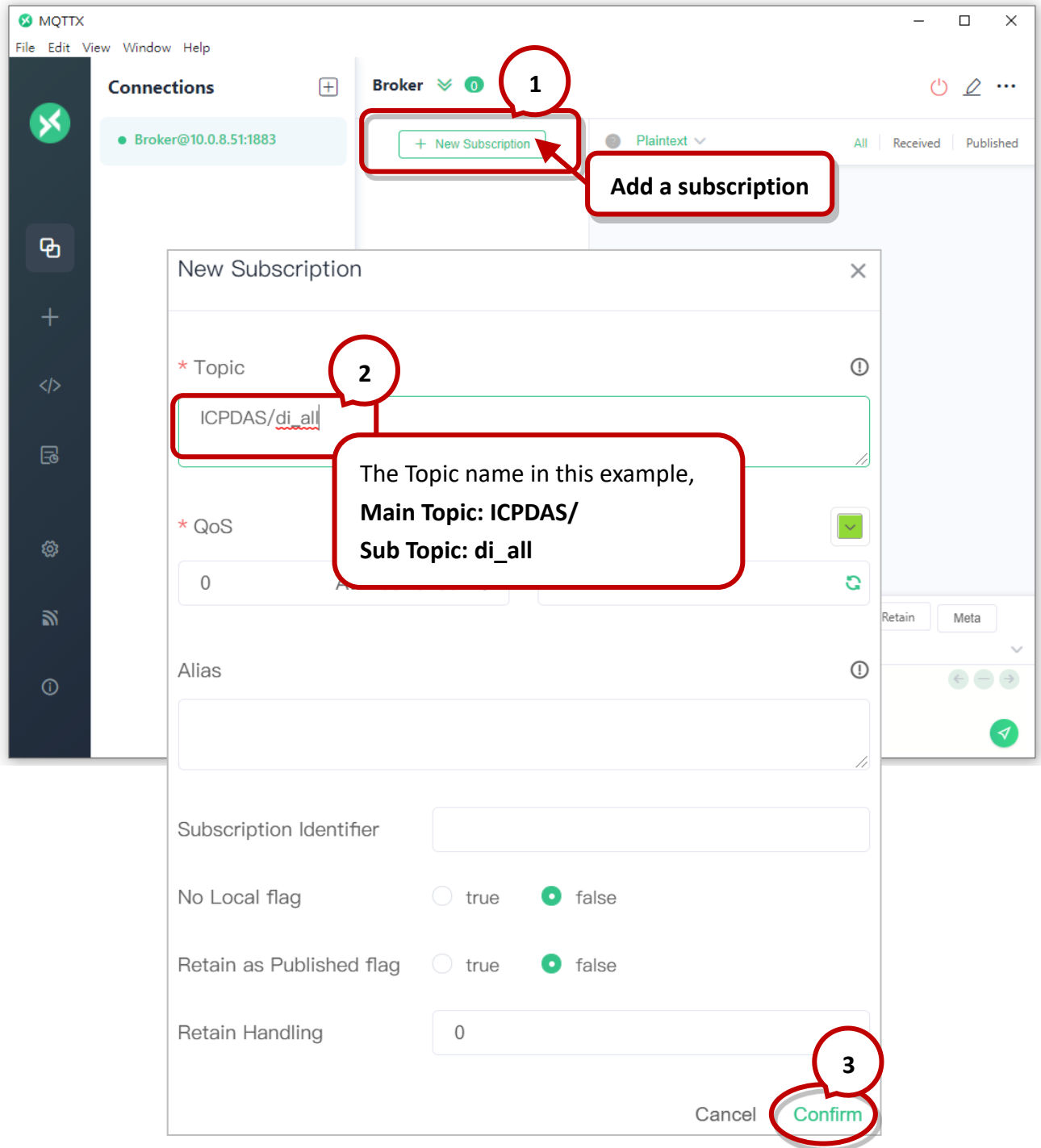

Step2. Log in to the module's Web Server, and click the **Periodic Publish** option for the "di_all" on the MQTT - "DI" page to enable the function. After that, click **Update** to save the changes.



Ethernet I/O Module
[Home](#) | [Network](#) | [I/O Settings](#) | [Sync](#) | [PWM](#) | [Pair](#) | [Filter](#) | [Monitor](#) | [Password](#) | [Logout](#)
 MQTT (Topics: [DO](#) | [DI](#)) | [SNMP](#)

MQTT - Digital Inputs

Digital Input	State-Change Publish	Periodic Publish	Sub Topic Name (Max. 63 chars)
ALL	<input type="checkbox"/>	<input checked="" type="checkbox"/>	di_all
Digital Input	State-Change Publish	Periodic Publish	Sub Topic Name (Max. 63 chars)
DI0	<input type="checkbox"/>	<input type="checkbox"/>	di00
DI1	<input type="checkbox"/>	<input type="checkbox"/>	di01
DI2	<input type="checkbox"/>	<input type="checkbox"/>	di02
DI3	<input type="checkbox"/>	<input type="checkbox"/>	di03
DI4	<input type="checkbox"/>	<input type="checkbox"/>	di04
DI5	<input type="checkbox"/>	<input type="checkbox"/>	di05
DI6	<input type="checkbox"/>	<input type="checkbox"/>	di06
DI7	<input type="checkbox"/>	<input type="checkbox"/>	di07

Step3. Go to the **MQTT** page, set the message publishing cycle (Cycle), and click "**Update Setting**" to save the changes.



Ethernet I/O Module
[Home](#) | [Network](#) | [I/O Settings](#) | [Sync](#) | [PWM](#) | [Pair](#) | [Filter](#) | [Monitor](#) | [Password](#) | [Logout](#)
 MQTT (Topics: [DO](#) | [DI](#)) | [SNMP](#)

Publication Settings

Publication	
Retain	<input type="checkbox"/>
Cycle	9000 (100 ~ 2147483000 ms, in 10 ms step, Default= 9000)
All Information	
Enable	Disable ▾
Sub Topic Name	info (Max. 63 chars)
Last Will and Testament	
Enable	<input type="checkbox"/>
Retain	<input type="checkbox"/>
QoS	0 - At most once ▾
Topic	N/A (Max. 63 chars)
Message	N/A (Max. 63 chars)

Step4. The user can view the received messages in the MQTTX window.

The **Cycle** setting is set to 9 seconds in this example. MQTTX will receive a message with all DI statuses per nine seconds.

Broker 137

+ New Subscription

ICPDAS/di_all QoS 0

Plaintext All Received Published

Topic: ICPDAS/di_all QoS: 0
0x1
2023-07-26 15:01:31:09

Topic: ICPDAS/di_all QoS: 0
0x1
2023-07-26 15:01:40:05

Topic: ICPDAS/di_all QoS: 0
0x0
2023-07-26 15:01:49:06

All statuses of DI channels
0x1: 0000 0001 (DO0 = ON)
0x0: 0000 0000 (OFF)

4.16.5 MQTT - AI Example



On the MQTT page, enter “broker.emqx.io” in the Broker field and enter “ICPDAS/” in the Main Topic Name field, then click the Update Settings button. Keep the value “9000” in the Cycle field.

Connectivity Settings

MQTT	Enable	
Broker	IPv4 / Host Name (Max. 127 chars) broker.emqx.io	Online MQTT broker: broker.emqx.io
Broker Port	1883	(Default= 1883)
Client Identifier	P/ET-2215H-16_FFFFFFFF	
User Name		(Max. 63 chars)
Password		(Max. 63 chars)
Reconnection Interval	10	(5 ~ 65000 s, Default= 10)
Keep Alive Interval	20	(5 ~ 65000 s, Default= 20)
Main Topic Name	ICPDAS/ (Max. 126 chars)	
<input type="button" value="Update Settings"/>		

Publication Settings

Publication	
Retain	<input type="checkbox"/>
Cycle	9000 100 ~ 2147483000 ms, in 10 ms step, Default= 9000)

On the MQTT – AI page, choose the AI0 and AI1 channels then click the Update button.

MQTT - Analog Input

Analog Input Channel	<input type="checkbox"/> Periodic Publish	Sub Topic Name (Max. 63 chars)
AI0	<input checked="" type="checkbox"/>	ai00
AI1	<input checked="" type="checkbox"/>	ai01
AI2	<input type="checkbox"/>	ai02
AI3	<input type="checkbox"/>	ai03
AI4	<input type="checkbox"/>	ai04
AI5	<input type="checkbox"/>	ai05
AI6	<input type="checkbox"/>	ai06
AI7	<input type="checkbox"/>	ai07
<input type="button" value="Update"/>		

(A) MQTT AI – Periodic Publish

Publish the AI values periodically according to the Cycle settings.

Step1. Add a Connection

Also refer to [MQTT page](#). The online public MQTT broker (broker.emqx.io) will be used in this example. Click “+” and select the **New Connection** to add a connection.

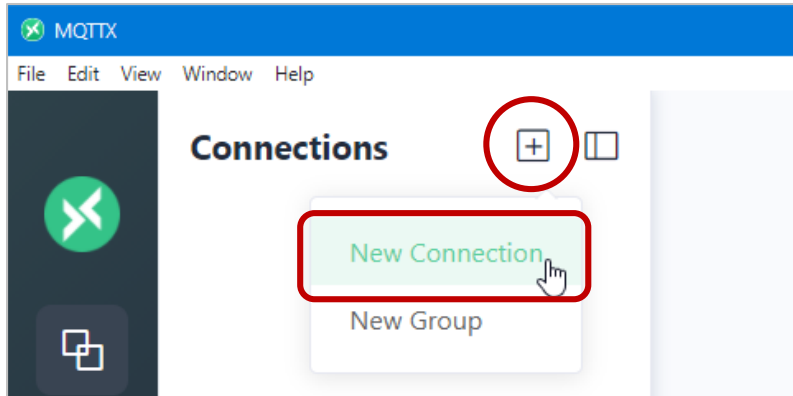

Enter a name that is easy to identify (e.g., Broker) in the **Name** field and enter the host name of the online MQTT broker (e.g., broker.emqx.io), then click the **Connect** button.

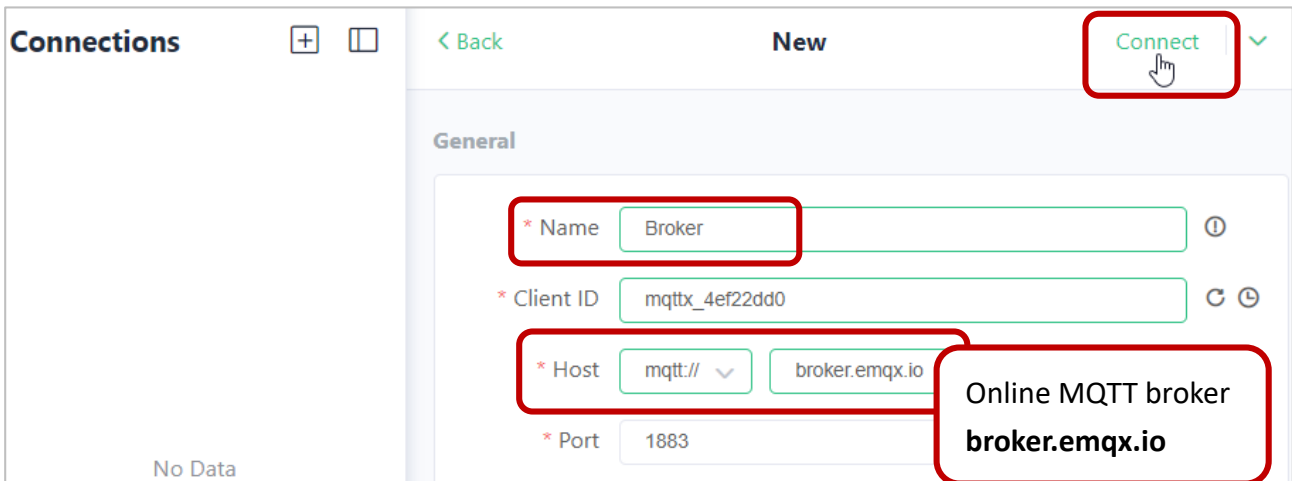

If the connection is successful, a green light will illuminate. To cancel the connection, simply click the red power button.

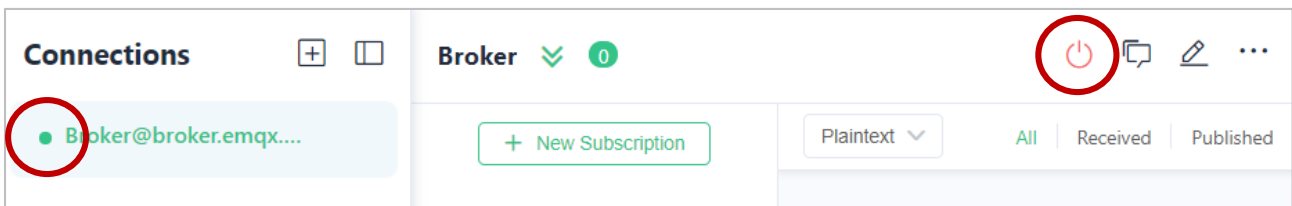

Step2. Add the subscription of Topics

In this example, there are two topics (i.e., ICPDAS/ai00, ICPDAS/ai01) will be subscribed. Click the “**New Subscription**” button and enter “**ICPDAS/ai00**” in the Topic field, then click the “**Confirm**” button.

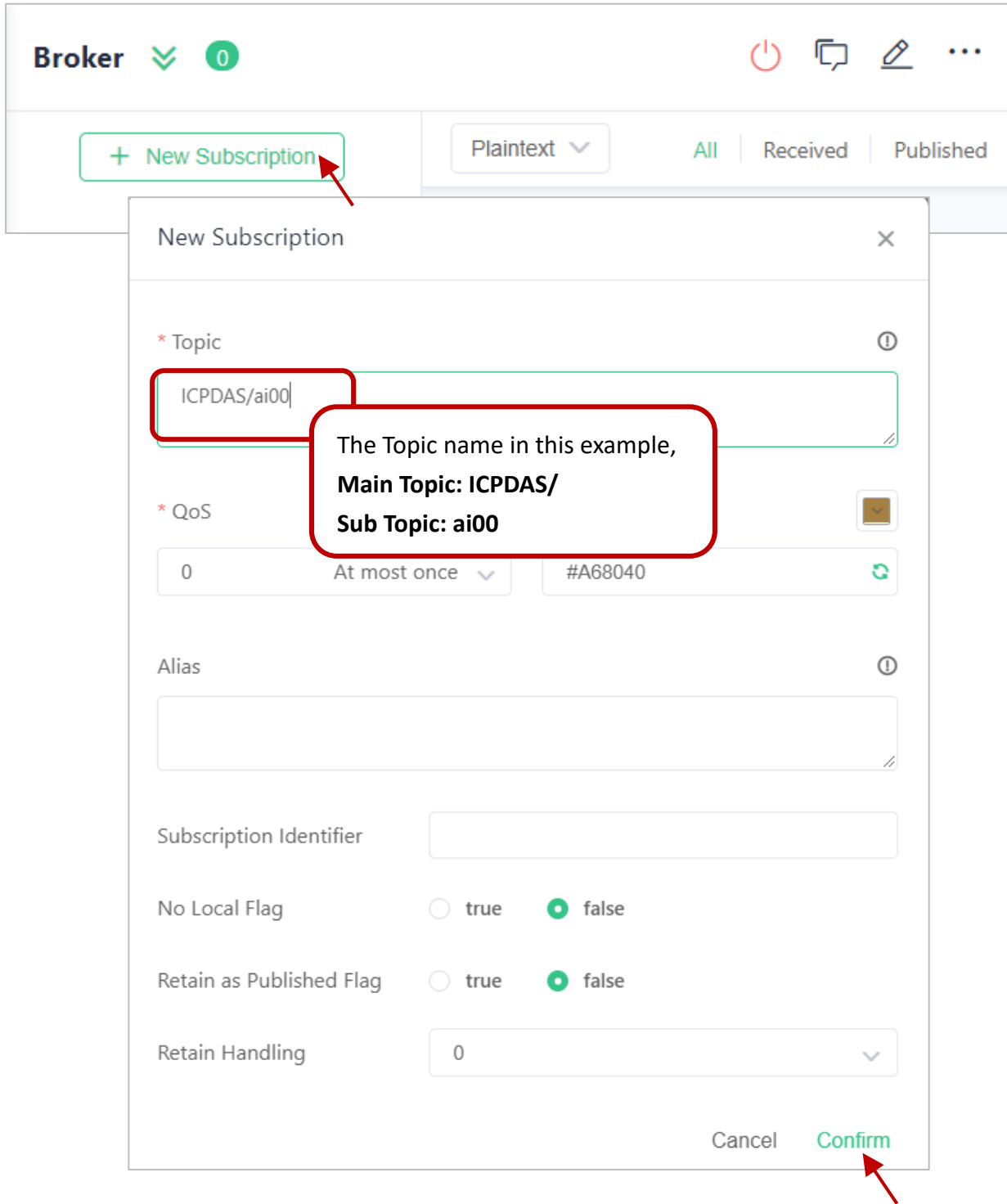

Using the same way to subscribe the “**ICPDAS/ai01**” topic.

Step3. View the messages of the subscribed Topics

In this case, the user subscribed messages will be published per nine seconds from the MQTT Broker. The PET-2215H-16 module features the open wire detection. When the AI value reads **-9999.9**, it indicates that the channel is disconnected. Check the wiring of the AI1.

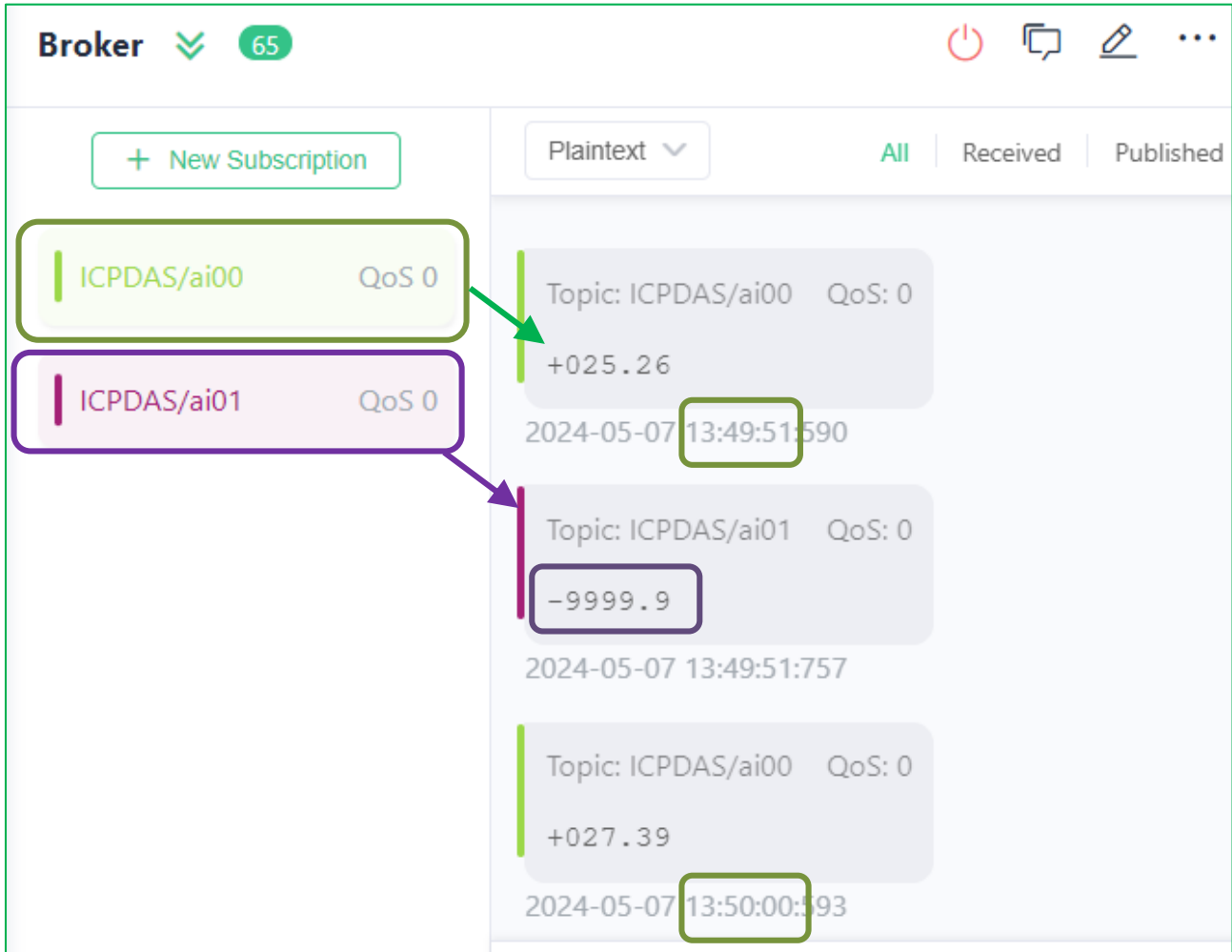

After reconnecting the wiring, the subscribed AI1 messages will be displayed every 9 seconds.



4.17 SNMP

The "SNMP" page provides the function for ET-2200 to send module information and I/O information to the SNMP Network Management Software or device to help administrators to monitor the status of the ET-2200 in real time.

If the Trap function is enabled, ET-2200 can actively send messages to the SNMP manager to keep track of data when the I/O status of the module changes or restarts. The detailed description is as follows.

Note:

For DI/DO modules:

SNMP function is available for **Firmware v2.3.4** and later. It is not supported for older versions.

For AI/AO modules:

SNMP function is available for **Firmware v1.60** and later. It is not supported for older versions.

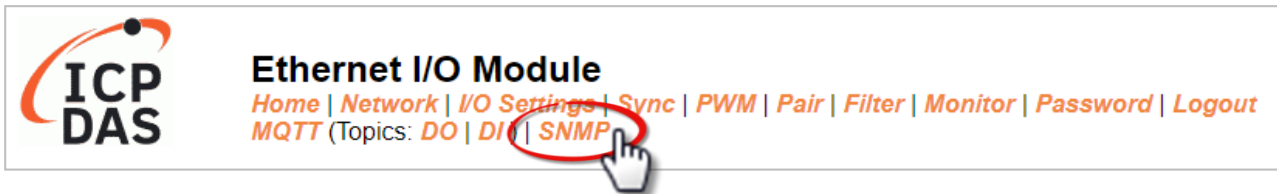

Note:

ET-2200 currently supports these MIB-II management items such as sysContact, sysLocation, sysDescr, and sysName.

4.17.1 SNMP Agent Configuration

System Info		Setting
Contact	User	(Max. 47 chars)
Location	Site	(Max. 47 chars)
Description	EtherIO	(Max. 47 chars)
Name	Device	(Max. 47 chars)
Function		Setting
Read-Only Community	public	(Max. 47 chars, example: public)
Read-Write Community	private	(Max. 47 chars, example: private)
Trap Community	public	(Max. 47 chars, example: public)
Manager / Trap IP #1	0.0.0.0	(IPv4/v6 Address, example: 10.0.8.123, fe80:0:0:0:a8ee:dc07:1cda:5678)
Manager / Trap IP #2	0.0.0.0	
Generic Trap	<input type="checkbox"/> Cold Start, <input type="checkbox"/> Warm Start	
Enable SNMP	<input type="checkbox"/> Check to enable. (Default disabled)	
Update Settings		

The table describes the parameters contained in the "System Info" section.

Item	Description	Default Value
Contact	The SNMP server's contact person	User
Location	The server's location	Site
Description	The description of the device displayed on the Server	EtherIO
Name	The name of the device displayed on the Server	Device

The table describes the parameters contained in the "Function" section.

Item	Description	Default Value
Read-Only Community	Set the community name of the module for read-only data	public
Read-Write Community	Set the community name of the module for read-write data	private
Trap Community	Set the community name of the module for the trap	public
Manager / Trap IP #1	Set the IP address of Trap IP #1	0.0.0.0
Manager / Trap IP #2	Set the IP address of Trap IP #2	0.0.0.0
Generic Trap	Select to enable the Cold Start or Warm Start function	Disabled
Enable SNMP	Select the box to enable the SNMP communication function and deselect to disable it	Disabled
Update Settings	After saving the settings, also reboot the module to take effect	

4.17.2 SNMP Specific Trap

SNMP Specific Trap									
Digital Input	State-Change / Specific ID (1-255)								
All <input type="checkbox"/> 1	A single trap contains all DI states when any DI changes.								
<input type="checkbox"/> DI 7 - 0	<table border="1"> <tr> <td>DI7:</td> <td>DI6:</td> <td>DI5: <input type="checkbox"/> 1</td> <td>DI4: <input type="checkbox"/> 1</td> <td>DI3: <input type="checkbox"/> 1</td> <td>DI2: <input type="checkbox"/> 1</td> <td>DI1: <input type="checkbox"/> 1</td> <td>DI0: <input type="checkbox"/> 1</td> </tr> </table>	DI7:	DI6:	DI5: <input type="checkbox"/> 1	DI4: <input type="checkbox"/> 1	DI3: <input type="checkbox"/> 1	DI2: <input type="checkbox"/> 1	DI1: <input type="checkbox"/> 1	DI0: <input type="checkbox"/> 1
DI7:	DI6:	DI5: <input type="checkbox"/> 1	DI4: <input type="checkbox"/> 1	DI3: <input type="checkbox"/> 1	DI2: <input type="checkbox"/> 1	DI1: <input type="checkbox"/> 1	DI0: <input type="checkbox"/> 1		
Digital Output	State-Change / Specific ID (1-255)								
All <input type="checkbox"/> 1	A single trap contains all DO states when any DO changes.								
<input type="checkbox"/> DO 7 - 0	<table border="1"> <tr> <td>DO7:</td> <td>DO6:</td> <td>DO5: <input type="checkbox"/> 1</td> <td>DO4: <input type="checkbox"/> 1</td> <td>DO3: <input type="checkbox"/> 1</td> <td>DO2: <input type="checkbox"/> 1</td> <td>DO1: <input type="checkbox"/> 1</td> <td>DO0: <input type="checkbox"/> 1</td> </tr> </table>	DO7:	DO6:	DO5: <input type="checkbox"/> 1	DO4: <input type="checkbox"/> 1	DO3: <input type="checkbox"/> 1	DO2: <input type="checkbox"/> 1	DO1: <input type="checkbox"/> 1	DO0: <input type="checkbox"/> 1
DO7:	DO6:	DO5: <input type="checkbox"/> 1	DO4: <input type="checkbox"/> 1	DO3: <input type="checkbox"/> 1	DO2: <input type="checkbox"/> 1	DO1: <input type="checkbox"/> 1	DO0: <input type="checkbox"/> 1		
<input type="button" value="Update Settings"/>									
<input type="button" value="Reboot"/> is required after SNMP configuration.									

The table describes the parameters contained in the " **Digital Input/ Digital Output** " section.

Item	Description
Digital Input	
All	All DI channels share a single Trap. Check the box to send a Trap message when any DI status changes. "Specific ID" is the ID number set for this Trap
DI 7-0	Each DI channel has a specific Trap. Check the box to enable the Trap function for that DI channel. "Specific ID" is the ID number set for individual channel
Digital Output	
All	All DO channels share a single Trap. Check the box to send a Trap message when any DO status changes. "Specific ID" is the ID number set for this Trap.
DO 7-0	Each DO channel has a specific Trap. Check the box to enable the Trap function for that DO channel. "Specific ID" is the ID number set for individual channel
Update Setting	After changing and saving the settings, also reboot the module to take effect
Reboot	Click the button to reboot the module

SNMP Specific Trap

Analog Output	State-Change	Specific ID (1-255)
A00	<input type="checkbox"/>	1
A01	<input type="checkbox"/>	1
A02	<input type="checkbox"/>	1
A03	<input type="checkbox"/>	1
A04	<input type="checkbox"/>	1
A05	<input type="checkbox"/>	1
A06	<input type="checkbox"/>	1
A07	<input type="checkbox"/>	1
<input type="button" value="Update Settings"/>		

The table describes the parameters contained in the " **Analog Output** " section.

Item	Description
Analog Output	
AO 7-0	Each AO channel has a specific Trap. Check the box to enable the Trap function for that AO channel. "Specific ID" is the ID number set for individual channel
Update Setting	After changing and saving the settings, also reboot the module to take effect
Reboot	Click the button to reboot the module

4.17.3 SNMP I/O Example

In this article, we use **iReasoning MIB Browser** as an example. Please download the installer (V14) from its official website and run the installer.

<http://www.ireasoning.com/mibbrowser.shtml>

Step1. Start the iReasoning MIB Browser. Click the **File** → **Load MIBs** on the menu bar and click the specified **MIB file** of the module (e.g. ICPDAS-ET2200-MIB_20220705.mib), then click the Open button to open it.

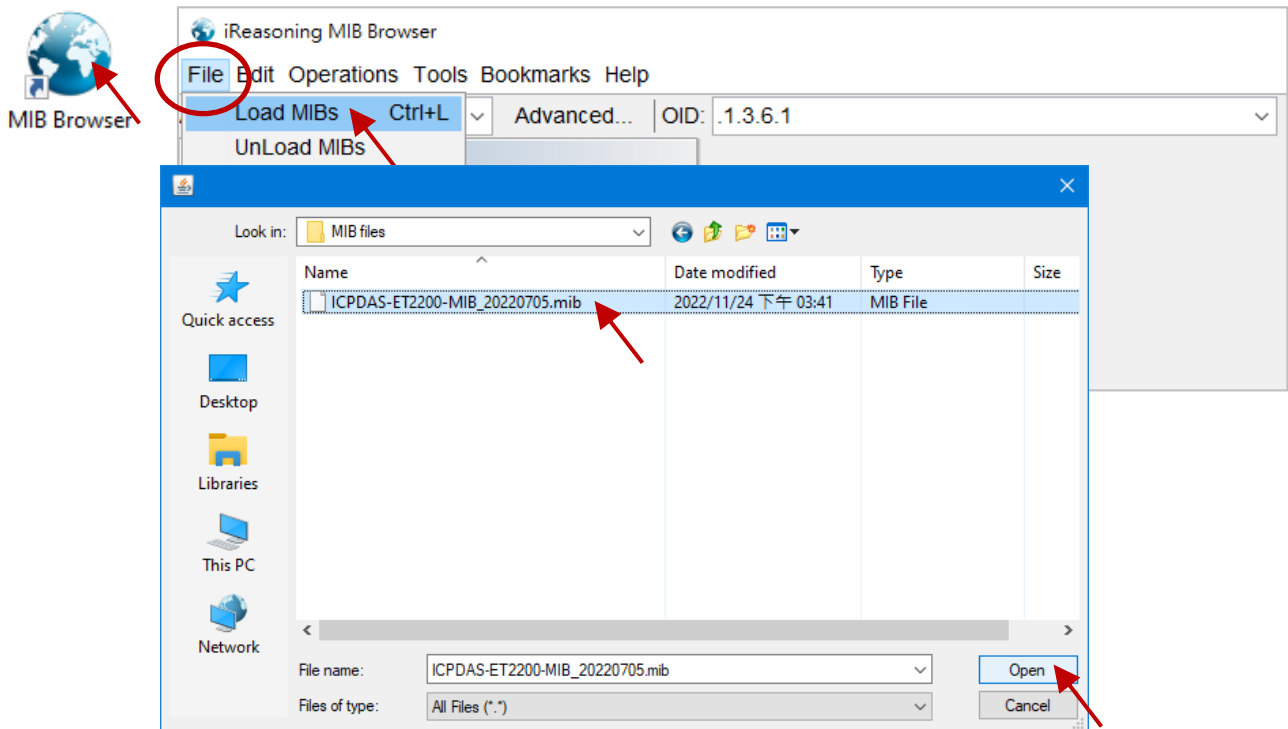

Step2. Enter the IP address of the ET-2200 module in the **Address** field.

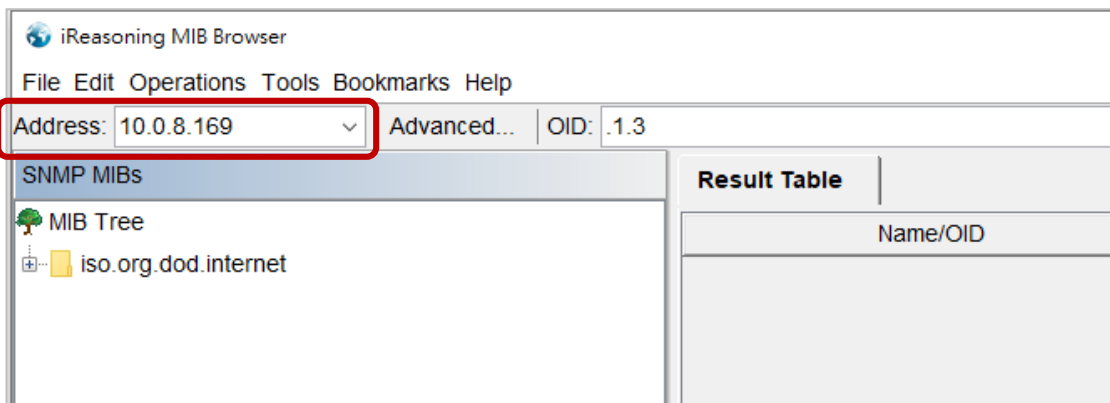

Step3. Click “**Advanced...**” to set the parameters of the SNMP agent. Enter the string in the **Read/Write Community** fields according to the **Read-Only Community / Read-Write Community** settings on the ET-2200. If these strings are different on both sides, the agent will not work correctly.

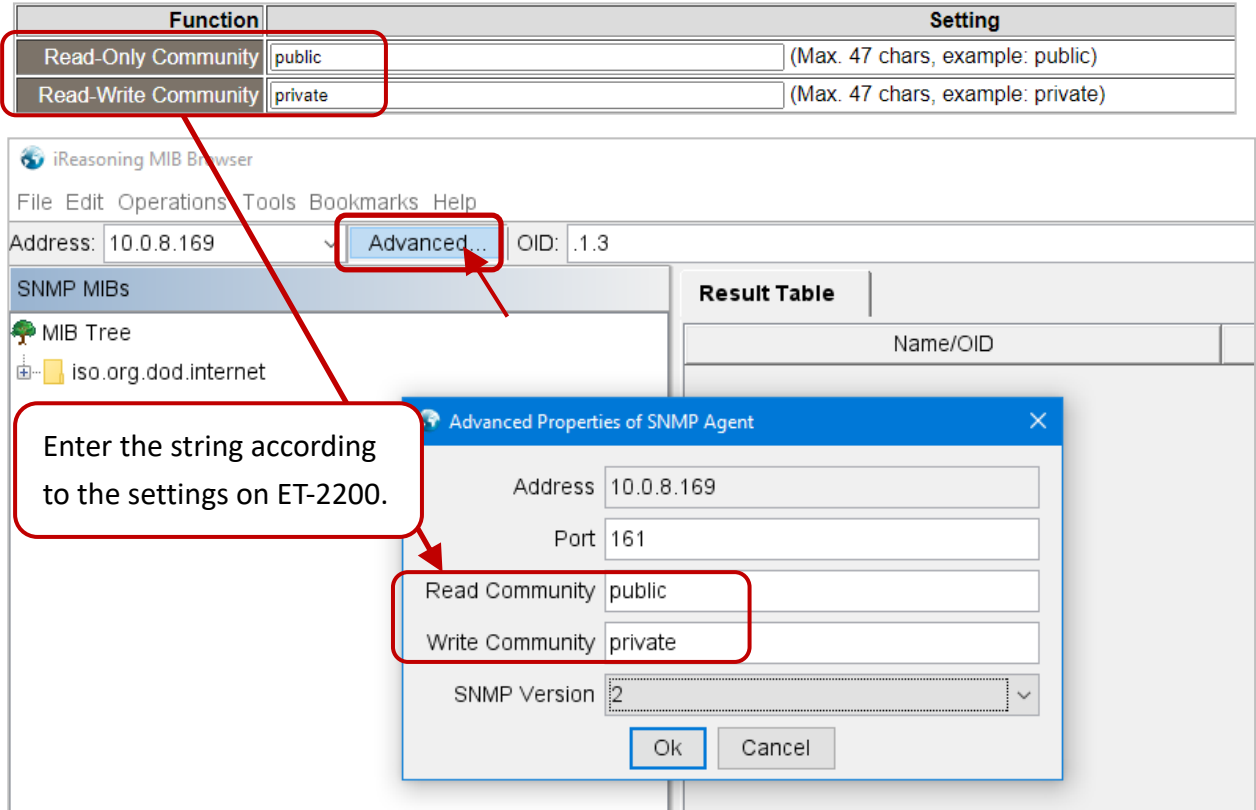

Note: If the **Write Community** field is not set, a Timeout error will occur during execution.

Step4. Enter the IP address of iReasoning MIB Browser in the **Manager/Trap IP #1** field and enable the SNMP function, then click **Update Settings** to save the changes, and finally click the **Reboot** button to reboot the ET-2200 module.

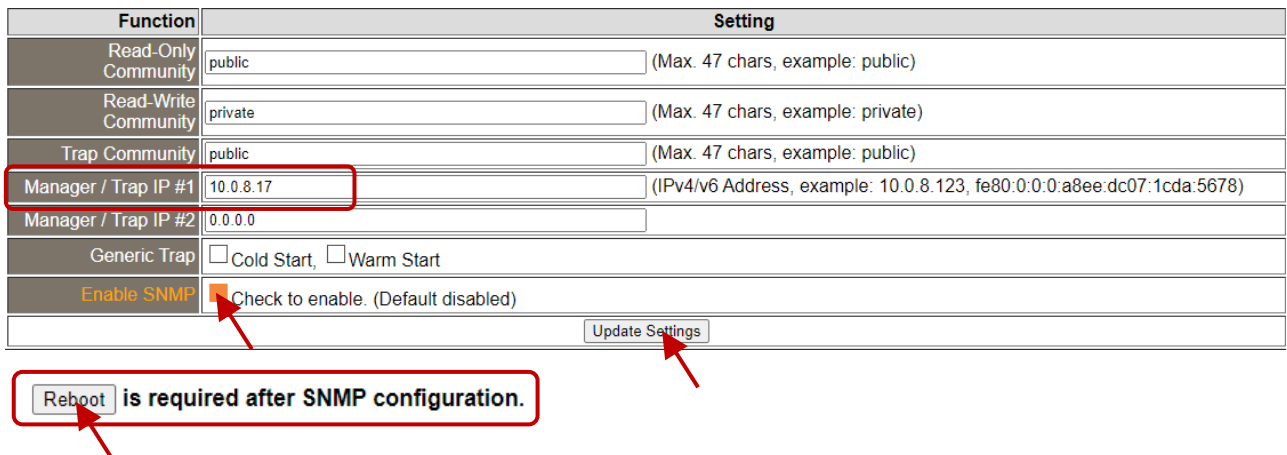

Read the information of the ET-2200 – the Walk command

To do: Right-click the **iso.org.dod.internet** folder on the left side and click **Walk** to display the information of the ET-2200 in the **Result Table**.

The screenshot shows the iReasoning MIB Browser interface. On the left, the MIB Tree is expanded to 'iso.org.dod.internet'. A context menu is open over this folder, with the 'Walk' option selected. The main window displays a 'Result Table' with columns for Name/OID, Value, Type, and IP:Port. A blue arrow points from the 'Counter32' entry in the first table to the second table, which is a detailed view of the 'Counter32' entry. A red box highlights the 'aiValue.1' through 'aiValue.8' rows in this second table, with a callout box stating: 'The information on analog inputs of the ET-2200.'

Name/OID	Value	Type	IP:Port
sysDescr.0	EtherIO	OctetString	10.0.8.16...
sysObjectID.0	icpdas	OID	10.0.8.16...
sysUpTime.0	48 minutes 46.13 seconds (292613)	TimeTicks	10.0.8.16...
sysContact.0	User	OctetString	10.0.8.16...
sysName.0	Device	OctetString	10.0.8.16...
sysLocation.0	Site	OctetString	10.0.8.16...
sysServices.0	72	Integer	10.0.8.16...
ifNumber.0	1	Integer	10.0.8.16...
ifIndex.1	1	Integer	10.0.8.16...
ifDescr.1	e0	OctetString	10.0.8.16...
ifType.1	ethernetCsmacd (6)	Integer	10.0.8.16...
ifMtu.1	1500	Integer	10.0.8.16...
ifSpeed.1	1000000	Gauge	10.0.8.16...
ifPhysAddress.1	00-0D-E0-A1-8A-9F	OctetString	10.0.8.16...
ifAdminStatus.1	up (1)	Integer	10.0.8.16...
ifOperStatus.1	up (1)	Integer	10.0.8.16...
ifLastChange.1	0 millisecond (0)	TimeTicks	10.0.8.16...
ifInOctets.1	0	Counter32	10.0.8.16...
snmpEnableAuthenTraps.0	disabled (2)	Integer	192.168...
1.3.6.1.2.1.11.31.0	0	Counter32	192.168...
1.3.6.1.2.1.11.32.0	0	Counter32	192.168...
modelName.0	P/ET-2217	OctetString	192.168...
aliasName.0	EtherIO	OctetString	192.168...
firmwareVersion.0	v01.6.0 [20221013]	OctetString	192.168...
webServerPort.0	80	Integer	192.168...
modbusTcpPort.0	502	Integer	192.168...
modbusTcpNetID.0	1	Integer	192.168...
aiIndex.1	1	Integer	192.168...
aiIndex.2	2	Integer	192.168...
aiIndex.3	3	Integer	192.168...
aiIndex.4	4	Integer	192.168...
aiIndex.5	5	Integer	192.168...
aiIndex.6	6	Integer	192.168...
aiIndex.7	7	Integer	192.168...
aiIndex.8	8	Integer	192.168...
aiName.1	AI0	OctetString	192.168...
aiName.2	AI1	OctetString	192.168...
aiName.3	AI2	OctetString	192.168...
aiName.4	AI3	OctetString	192.168...
aiName.5	AI4	OctetString	192.168...
aiName.6	AI5	OctetString	192.168...
aiName.7	AI6	OctetString	192.168...
aiName.8	AI7	OctetString	192.168...
aiValue.1	+0.003V	OctetString	192.168...
aiValue.2	+0.002V	OctetString	192.168...
aiValue.3	+0.003V	OctetString	192.168...
aiValue.4	+0.002V	OctetString	192.168...
aiValue.5	+0.003V	OctetString	192.168...
aiValue.6	+0.002V	OctetString	192.168...
aiValue.7	+0.002V	OctetString	192.168...
aiValue.8	+0.002V	OctetString	192.168...

Control the DO channel to ON/OFF – the SET command

To do: Right-click the **doValue** entry in the **Result Table** and click **Set** to display the **SNMP SET** dialog box. Enter the value 0 (OFF) or 1 (ON) in the **Value** field to set the DO value.

The screenshot shows a 'Result Table' with the following data:

Name/OID	Value	Type	IP:Port
doName.1	DO0	OctetString	10.0.8.16...
doName.2	DO1	OctetString	10.0.8.16...
doName.3	DO2	OctetString	10.0.8.16...
doName.4	DO3	OctetString	10.0.8.16...
doName.5	DO4	OctetString	10.0.8.16...
doName.6	DO5	OctetString	10.0.8.16...
doValue.1	off (0)	Integer	10.0.8.16...
doValue.2	on (1)		16...
doValue.3	off (0)		16...
doValue.4	off (0)		16...
doValue.5	off (0)		16...
doValue.6			
doIndex.1			
doIndex.2			
doIndex.3			
doIndex.4			
doIndex.5			
doIndex.6			
doName.1			

The 'SNMP SET' dialog box is open, showing:

- OID: .1.3.6.1.4.1.34321.20.1.2.2.1.3.1
- Data Type: Integer
- Value: {off(0), on(1)}

After setting the value, execute the Walk command by right-clicking the **iso.org.dod.internet** folder on the left side of the window to update the value.

Set the outputs of the AO channel – the SET command

To do: Right-click the **aoValue** entry in the **Result Table** and click **Set** to display the **SNMP SET** dialog box. Enter the value **1.000** (output 1V) in the **Value** field to set the AO value.

Name/OID	Value	Type	IP:Port /
snmpEnableAuthenTraps.0	disabled (2)	Integer	192.168.1...
.1.3.6.1.2.1.11.31.0	0	Counter32	192.168.1...
.1.3.6.1.2.1.11.32.0	0	Counter32	192.168.1...
modelName.0	P/ET-2228	OctetString	192.168.1...
aliasName.0	EtherIO	OctetString	192.168.1...
firmwareVersion.0	v01.6.0 [20221013]	OctetString	192.168.1...
webServerPort.0	80	Integer	192.168.1...
modbusTcpPort.0	502	Integer	192.168.1...
modbusTcpNetID.0	1	Integer	192.168.1...
aoIndex.1	1	Integer	192.168.1...
aoIndex.2	2	Integer	192.168.1...
aoIndex.3	3	Integer	192.168.1...
aoIndex.4	4	Integer	192.168.1...
aoIndex.5	5	Integer	192.168.1...
aoIndex.6	6	Integer	192.168.1...
aoIndex.7	7	Integer	192.168.1...
aoIndex.8	8	Integer	192.168.1...
aoName.1	AO0	OctetString	192.168.1...
aoName.2	AO1	OctetString	192.168.1...
aoName.3	AO2	OctetString	192.168.1...
aoName.4	AO3	OctetString	192.168.1...
aoName.5	AO4	OctetString	192.168.1...
aoName.6	AO5	OctetString	192.168.1...
aoName.7	AO6	OctetString	192.168.1...
aoName.8	AO7	OctetString	192.168.1...
aoHexValue.1	+0.000V	OctetString	192.168.1...
aoHexValue.2	+0.000V	OctetString	192.168.1...
aoHexValue.3	+	OctetString	192.168.1...
aoHexValue.4	+	OctetString	192.168.1...
aoHexValue.5	+	OctetString	192.168.1...
aoHexValue.6	+	OctetString	192.168.1...
aoHexValue.7	+	OctetString	192.168.1...
aoHexValue.8	+	OctetString	192.168.1...
aoHexValue.8	(\$	OctetString	192.168.1...

OID	Data Type	Value
.1.3.6.1.4.1.34321.20.1.2.4.1.3.1	OctetString	1.000

After completing the setting, execute the **Walk** command by right-clicking the **iso.org.dod.internet** folder on the left side of the window to update the value.

aoName.7	AO6	OctetString	192.168....
aoName.8	AO7	OctetString	192.168....
aoHexValue.1	+1.001V	OctetString	192.168....
aoHexValue.2	+0.000V	OctetString	192.168....
aoHexValue.3	+0.000V	OctetString	192.168....

4.17.4 SNMP Trap Example

Step1. Click **Tools** → **Trap Receiver** on the menu bar to display the window for receiving the Trap messages.

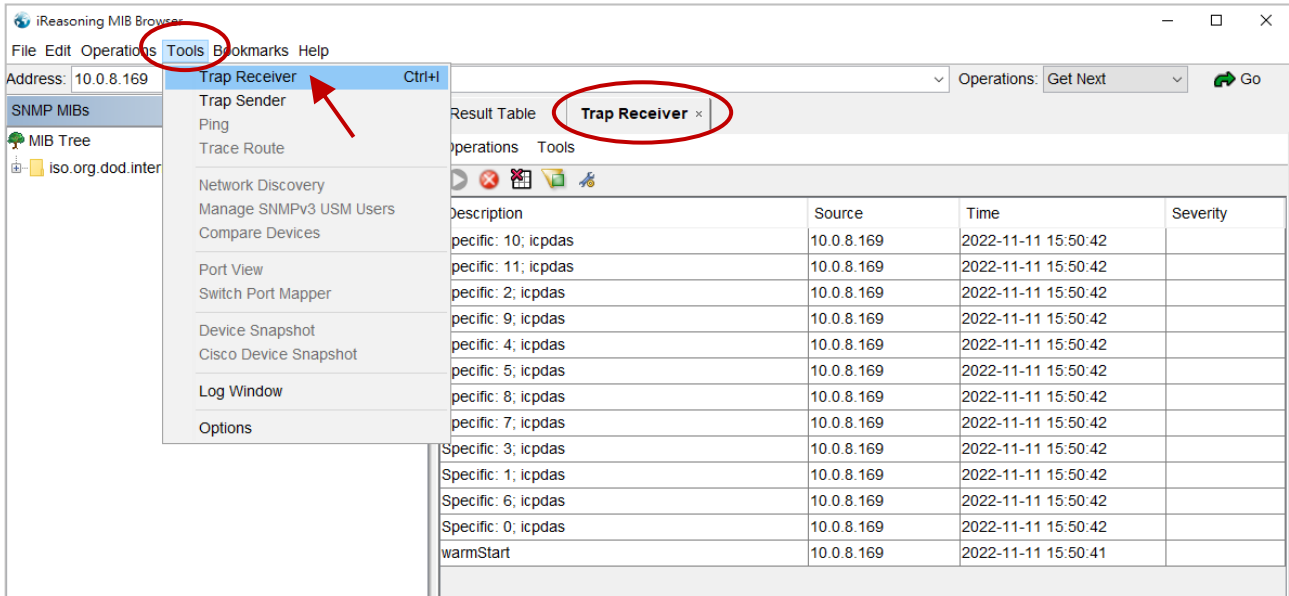

Step2. The Trap types for the alarms that receive from the ET-2200 module are as follows.

- Cold Start Trap:**
The Cold Start Trap will be sent when the module restarts after it has been completely powered off.
- Warm Start Trap:**
The Warm Start Trap will be sent when the module restarts without turning off the power. For example, the reboot command or the watchdog mechanism.
- Specific Trap (DI/DO/AO State-Change):**
When the specified DO/DI/AO channel is enabled, if the I/O status changes (e.g., ON/OFF or value change), a Trap message with a Specific ID, source IP, and time will be sent. This makes it easier to analyze the cause of the alarm and handle it appropriately.

Click the Trap message to view the details

Description	Source	Time	Severity
Specific: 1; icpdas	10.0.8.169	2022-11-14 14:22:58	
Specific: 1; icpdas	10.0.8.169	2022-11-14 14:22:57	

Source:	10.0.8.169	Timestamp:	1 hour 4 minutes 48 seconds	SNMP Version:	1
Enterprise:	icpdas	Community:	public		
Specific:	1	Generic:	enterpriseSpecific		
Variable Bindings:					
Name:	trapMessage				
Value:	[OctetString] DO0=1				
Description:					

Item	Description
Source	The IP address of the Trap from the device
Timestamp	How much time has passed after the module starts
SNMP Version	The version of SNMP
Enterprise	The name of the enterprise
Community	SNMP community name according to the Trap Community setting on the ET-2200.
Specific	Specific ID
Generic	Generic ID
Name	The generic name for the Trap
Value	The I/O channel and status value of the module (e.g., 0 = OFF, 1 = ON, or an AO value)

4.17.5 SNMP Problem Solving

Unable to receive the Trap message from the device

1. Check the setting of the Windows firewall or the Anti-virus software. These functions can be disabled during the testing.
2. Check the setting of the Trap port. Using **iReasoning MIB Browser** as an example,

Click the **Trap Receiver Settings** button on the **Trap Receiver** page to open the window. Then, confirm the Trap Port, Bind IP, and Transport settings. The ET-2200 module uses the default Trap Port **162** under SNMP specifications.

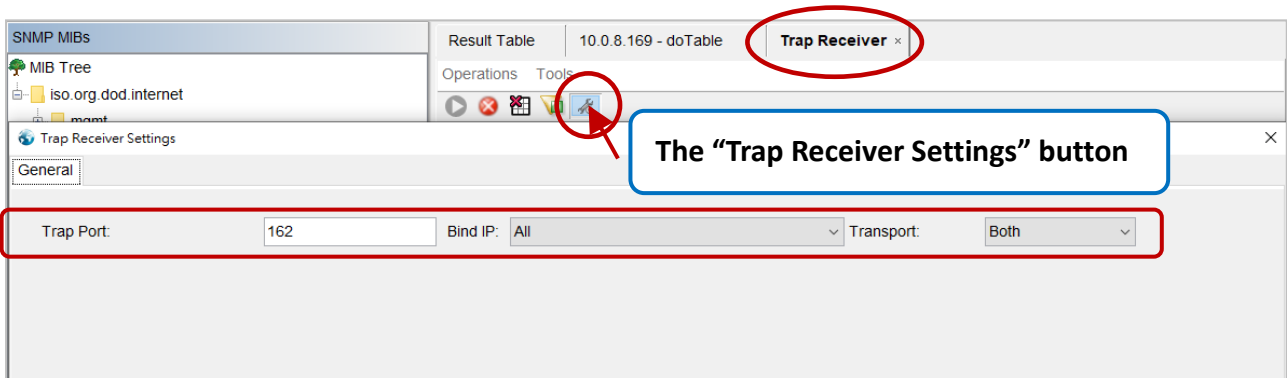

3. Disable Windows SNMP Trap Service.
Note: Different versions of Windows have different configuration interfaces. The following example is based on Windows 10.

Step1. Open the **Control Panel** window and click **Administrative Tools**.

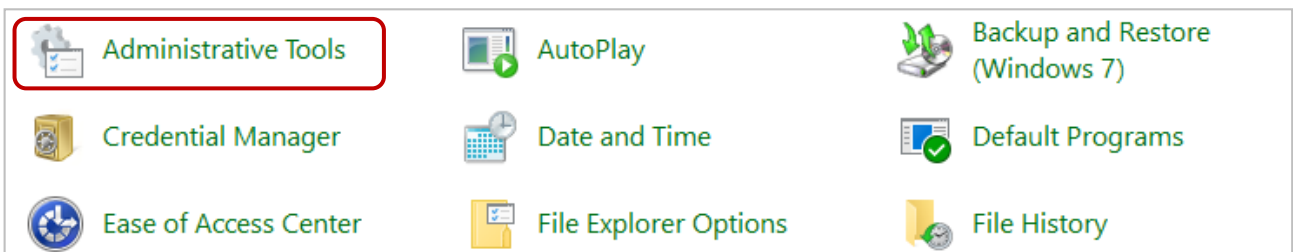

Step2. Double-click the **Services** icon.

Registry Editor	2019/12/7 下午 05:09	Shortcut	2 KB
Resource Monitor	2019/12/7 下午 05:09	Shortcut	2 KB
Services	2019/12/7 下午 05:09	Shortcut	2 KB
System Configuration	2019/12/7 下午 05:09	Shortcut	2 KB
System Information	2019/12/7 下午 05:09	Shortcut	2 KB
Task Scheduler	2019/12/7 下午 05:09	Shortcut	2 KB
Windows Defender Firewall with Advanc...	2019/12/7 下午 05:08	Shortcut	2 KB
Windows Memory Diagnostic	2019/12/7 下午 05:09	Shortcut	2 KB

Step3. Double-click the **SNMP Trap** and confirm the **Startup type** is set to “**Disabled**” and the **Service status** is set to “**Stopped**”.

The screenshot shows the Windows Services console with the 'SNMP Trap' service selected. The 'SNMP Trap Properties (Local Computer)' dialog box is open, showing the following details:

- Service name:** SNMPTRAP
- Display name:** SNMP Trap
- Description:** Receives trap messages generated by local or remote Simple Network Management Protocol (SNMP) agents and forwards the messages to...
- Path to executable:** C:\WINDOWS\System32\snmptrap.exe
- Startup type:** Disabled
- Service status:** Stopped

Buttons for 'Start', 'Stop', 'Pause', and 'Resume' are visible at the bottom of the dialog box.

5. I/O Pair Connection Applications

The ET-2200 series modules can establish remote logical I/O connections via Ethernet. After configuring the settings, it becomes possible to continuously read the DI status of the local (or remote) module and then write it to the DO of the remote (or local) module. This function is useful when connecting DI/DO modules that have no Ethernet functionality.

To configure the Pair-Connection function, please consult the following chapters.

5.1 Set a Single Module to Pull/Push Mode (DI/DO)

➤ **Step 1: Connect the Module to the Network, PC, and Power Supply**

Confirm that the ET-2200 series modules are functioning correctly. Refer to [Chapter 3. “Getting Started”](#) for more details. Here is the schematic diagram for this example, utilizing the ET-2260 module.

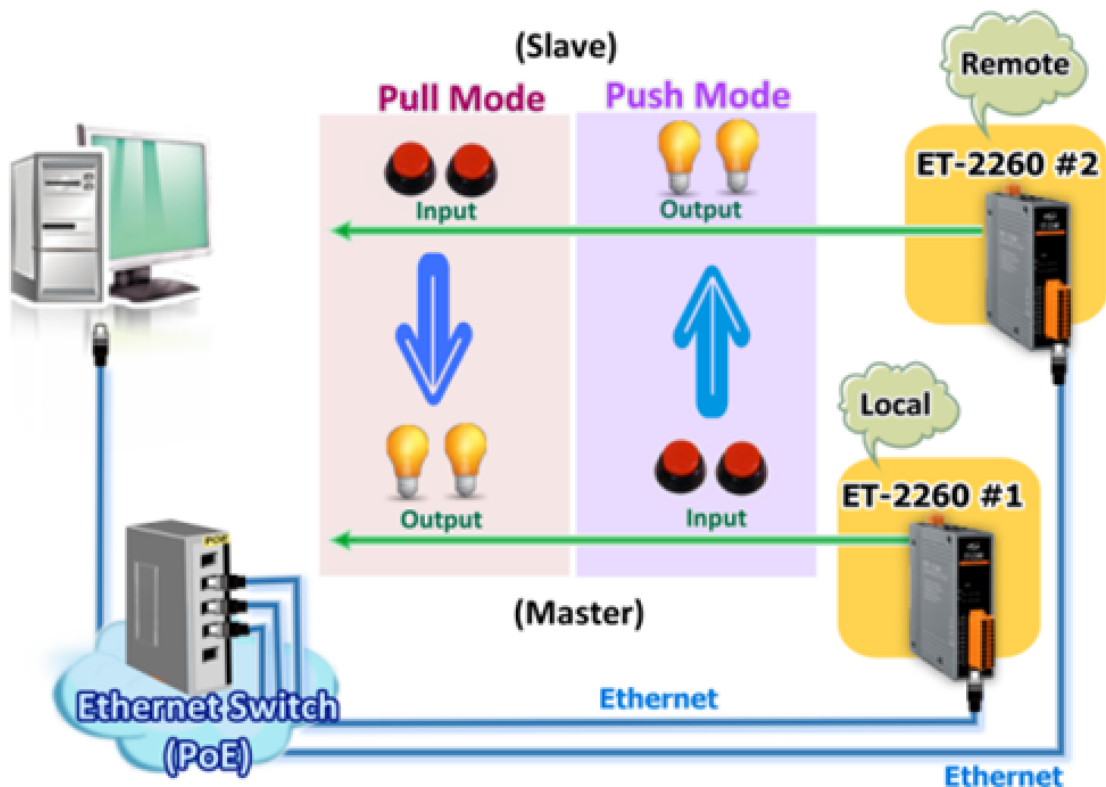

➤ **Step 2: Configure the Ethernet Settings**

Contact your network administrator to get the correct network configuration information (e.g., IP/Mask/Gateway) needed to set up I/O modules. For more instructions, refer to [Section 3.3](#) “Configuring the Network Settings”.

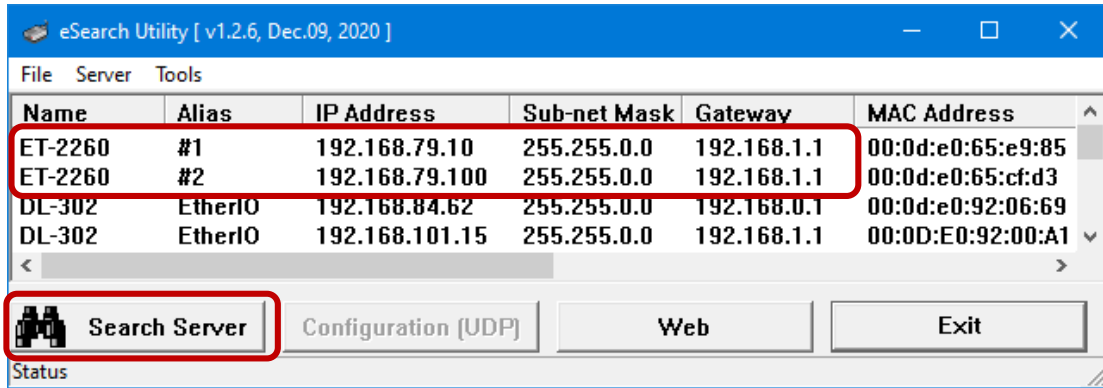

➤ **Step 3: Log into the ET-2200 Web Server**

1. Choose the **ET-2200** module within the eSearch Utility and then click the “**Web**” button to open the login webpage.
2. Enter the password in the **Login password** field (Defaults: “**Admin**”) and click the “**Submit**” button to log into the Web Server.

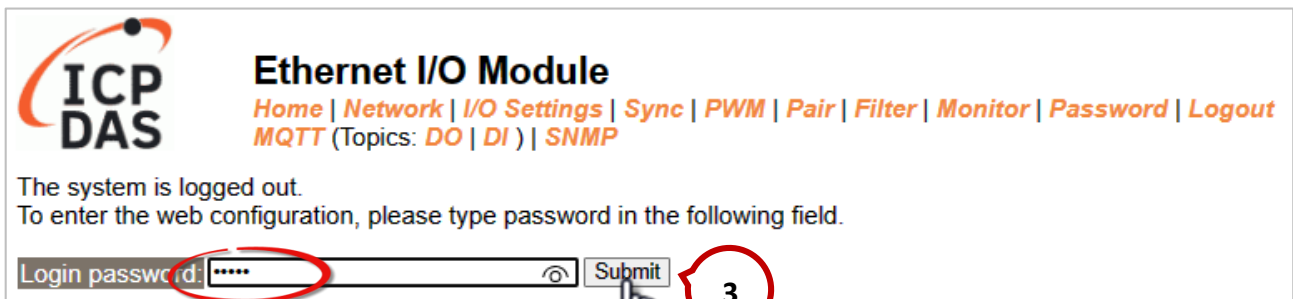
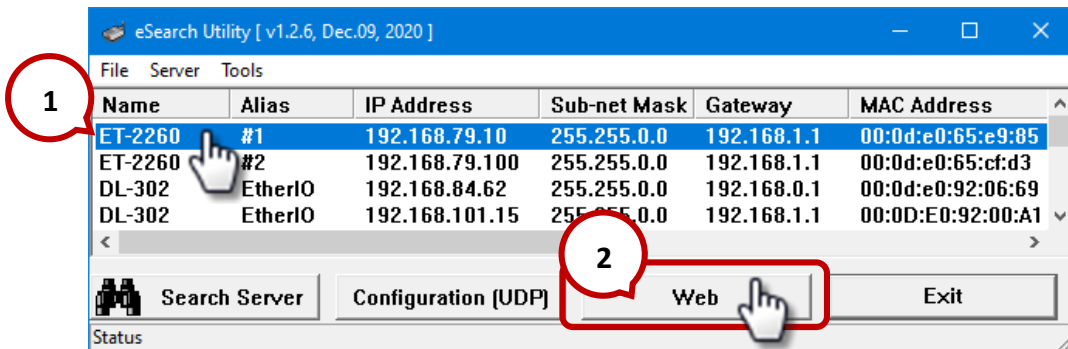

3. Click the “Pair” tab to display the I/O Pair-connection Settings page.

Ethernet I/O Module
[Home](#) | [Network](#) | [I/O Settings](#) | [Sync](#) | [PWM](#) | [Pair](#) | [Filter](#) | [Monitor](#) | [Password](#) | [Logout](#)
 MQTT (Topics: [DO](#) | [DI](#)) | [SNMP](#)

Model Name	ET-2260	Alias Name	EtherIO
Firmware Version	v2.4.0 [Sep.06 2022]	MAC Address	00-0d-e0-65-e9-85
IP Address	192.168.15.60	Initial Switch	ON
TCP Timeout (Socket Watchdog, Seconds)	180	System Timeout (Network Watchdog, Seconds)	0

5.1.1 Pull Mode

1. In the **Pair-Connection Setting** section, choose **PULL** and check the box in the **Enable Mode** field to enable this mode.
2. In the **Remote IP... : Port** fields, enter the IP address and TCP Port of the remote **ET-2260#2** module.
3. In the **IO Count** field, enter the mapped quantity for DI and DO.

For example, the **PULL Mode (Remote DI to Local DO)** configuration:

Enter “2” in the “IO Count” field and “0” in both the **Local/Remote IO Address** fields. This means **DI0** and **DI1** of **ET-2260#2** module correspond to **DO0** and **DO1** of **ET-2260#1** module.

4. In the **Local IO Address** field, select “0x: Coil Output...” and enter the starting **DO** address. In the **Remote IO Address** field, select “1x: Discrete Input...” and enter the starting **DI** address.
5. Choose the Modbus protocol (e.g., **TCPv4**) from the **Network Protocol** drop-down menu.
6. Click the “**Submit...**” button to complete the configuration.

Pair-Connection Settings: 9-16 |

#	Enable Mode	Remote IPv4 / IPv6 / Host Name (Max. 127 chars) : Port	Net ID	Scan Time (ms)	IO Count	Local IO Address	Remote IO Address	Network Protocol
01	<input checked="" type="checkbox"/> PULL	192.168.79.100 : 502	1	1000	2	0x:Coil Ot 0	1x:Discret 0	TCPv4
02	<input type="checkbox"/> PULL	: 502	1	1000	1	0x:Coil Ot 0	0x:Coil Ot 0	TCPv4
03	<input type="checkbox"/> PULL	: 502	1	1000	1	0x:Coil Ot 0	0x:Coil Ot 0	TCPv4
04	<input type="checkbox"/> PULL	: 502	1	1000	1	0x:Coil Ot 0	0x:Coil Ot 0	TCPv4
05	<input type="checkbox"/> PULL	: 502	1	1000	1	0x:Coil Ot 0	0x:Coil Ot 0	TCPv4

5.1.2 Push Mode

1. In the **Pair-Connection Setting** section, choose **PUSH** and check the box in the **Enable Mode** field to enable this mode.
2. In the **Remote IP... : Port** fields, enter the IP address and the TCP Port of the remote **ET-2260#2** module
3. In the **IO Count** field, enter the mapped quantity for DI and DO.

For example, the **PUSH Mode (Local DI to Remote DO)** configuration:

Enter “2” in the **IO Count** field and “0” in both the **Local/Remote IO Address** fields. This means **DI0 and DI1** of **ET-2260#1** module correspond to **DO0 and DO1** of **ET-2260#2** module.

4. In the **Local IO Address** field, select “1x: Discrete Input..” and enter the starting **DI** address. In the **Remote IO Address** field, select “0x: Coil Output...” and enter the starting **DO** address.
5. Choose the Modbus protocol (e.g., **TCPv4**) from the **Network Protocol** drop-down menu.
6. Click the “**Submit...**” button to complete the configuration.

Model Name	ET-2260	Alias Name	#1
Firmware Version	v2.4.0 [Sep.06 2022]	MAC Address	00-0d-e0-65-cf-d3
IP Address	192.168.79.10	Initial Switch	OFF
TCP Timeout (Socket Watchdog, Seconds)	180	System Timeout (Network Watchdog, Seconds)	0

Pair-Connection Settings: | 9-16 |

#	Enable Mode	Remote IPv4 / IPv6 / Host Name (Max. 127 chars) : Port	Net ID	Scan Time (ms)	IO Count	Local IO Address	Remote IO Address	Network Protocol
01	<input type="checkbox"/> PULL	192.168.79.100 : 502	1	1000	2	0x:Coil 0	1x:Dis 0	TCPv4
02	<input checked="" type="checkbox"/> PUSH	192.168.79.100 : 502	1	1000	2	1x:Dis 0	0x:Coil 0	TCPv4
03	<input type="checkbox"/> PULL	: 502	1	1000	1	0x:Coil 0	0x:Coil 0	TCPv4
04	<input type="checkbox"/> PULL	: 502	1	1000	1	0x:Coil 0	0x:Coil 0	TCPv4
05	<input type="checkbox"/> PULL	: 502	1	1000	1	0x:Coil 0	0x:Coil 0	TCPv4
06	<input type="checkbox"/> PULL	: 502	1	1000	1	0x:Coil 0	0x:Coil 0	TCPv4
07	<input type="checkbox"/> PULL	: 502	1	1000	1	0x:Coil 0	0x:Coil 0	TCPv4
08	<input type="checkbox"/> PULL	: 502	1	1000	1	0x:Coil 0	0x:Coil 0	TCPv4

Note:
 PULL Mode = Remote to Local
 PUSH Mode = Local to Remote
 Pair-connection is disabled if the IO Count is 0 (no data)
 IO Address (base 0): 0 - 65535, no leading 0x/1x/3x/4x.

5.2 Set Two Modules to Push Mode (Local DI to Remote DO)

➤ Step 1: Connect the Module to the Network, PC, and Power Supply

Confirm that the ET-2200 series modules are functioning correctly. Refer to [Chapter 3 “Getting Started”](#) for more details. Here is the schematic diagram for this example, utilizing the **ET-2260** module.

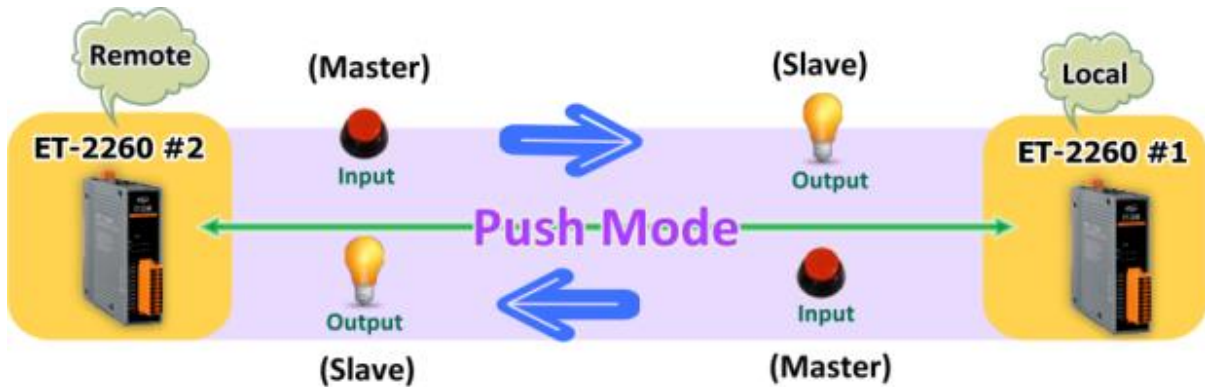

➤ Step 2: Configure the Ethernet Settings

Contact your network administrator to get the correct network configuration information (e.g., IP/Mask/Gateway) needed to set up I/O modules. For more instructions, refer to [Section 3.3 “Configuring the Network Settings”](#).

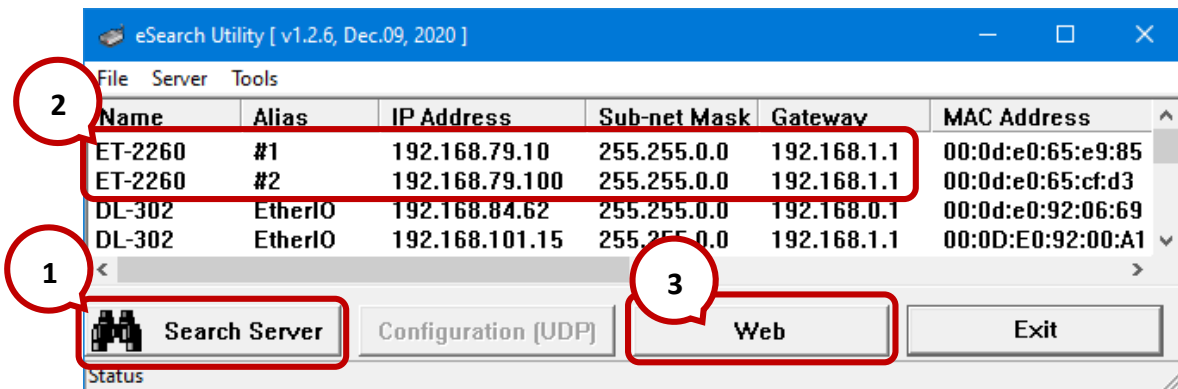

➤ Step 3: Log into the ET-2200 Web Server

1. Choose the **ET-2260#1** or **ET-2260#2** module within the eSearch Utility and then click the **“Web”** button to open the login webpage.
2. Enter the password in the **Login password** field (**Defaults: “Admin”**) and click the **“Submit”** button to log into the Web Server. (See [Section 5.1 – Step3](#))

➤ **Step 4-1: Configure the Pair-Connection for the ET-2260#1 (Push Mode)**

1. Click the **Pair** tab to display the configuration page.
2. In the **Pair-Connection Setting** section, choose **PUSH** and check the box in the **Enable Mode** field to enable this mode.
3. In the **Remote IP... : Port** fields, enter the IP address and the TCP Port of the remote **ET-2260#2** module
4. In the **IO Count** field, enter the mapped quantity for DI and DO.

For example, the **PUSH Mode (Local DI to Remote DO)** configuration:
 Enter “1” in the **IO Count** field and “0” in both the **Local/Remote IO Address** fields.
 This means **DI0** of **ET-2260#1** module correspond to **DO0** of **ET-2260#2** module.

5. In the **Local IO Address** field, select “1x: Discrete Input..” and enter the starting **DI** address.
 In the **Remote IO Address** field, select “0x: Coil Output...” and enter the starting **DO** address.
6. Choose the Modbus protocol (e.g., **TCPv4**) from the **Network Protocol** drop-down menu.
7. Click the “**Submit...**” button to complete the configuration.

Model Name	ET-2260	Alias Name	#1
Firmware Version	v2.4.0 [Sep.06 2022]	MAC Address	00-0d-e0-65-cf-d3
IP Address	192.168.79.10	Initial Switch	OFF
TCP Timeout (Socket Watchdog, Seconds)	180	System Timeout (Network Watchdog, Seconds)	0

Pair-Connection Settings: Submit 1-8 9-16 |

#	Enable Mode	Remote IPv4 / IPv6 / Host Name (Max. 127 chars) : Port	Net ID	Scan Time (ms)	IO Count	Local IO Address	Remote IO Address	Network Protocol
01	<input checked="" type="checkbox"/> PUSH	192.168.79.100 : 502	1	1000	1	1x:Discrete Input 0	0x:Coil Output 0	TCPv4
02	<input type="checkbox"/> PULL	: 502	1	1000	1	0x:Coil Output 0	0x:Coil Output 0	TCPv4
03	<input type="checkbox"/> PULL	: 502	1	1000	1	0x:Coil Output 0	0x:Coil Output 0	TCPv4
04	<input type="checkbox"/> PULL	: 502	1	1000	1	0x:Coil Output 0	0x:Coil Output 0	TCPv4
05	<input type="checkbox"/> PULL	: 502	1	1000	1	0x:Coil Output 0	0x:Coil Output 0	TCPv4
06	<input type="checkbox"/> PULL	: 502	1	1000	1	0x:Coil Output 0	0x:Coil Output 0	TCPv4
07	<input type="checkbox"/> PULL	: 502	1	1000	1	0x:Coil Output 0	0x:Coil Output 0	TCPv4
08	<input type="checkbox"/> PULL	: 502	1	1000	1	0x:Coil Output 0	0x:Coil Output 0	TCPv4

Note:
 PULL Mode = Remote to Local
 PUSH Mode = Local to Remote
 Pair-connection is disabled if the IO Count is 0 (no data)
 IO Address (base 0): 0 - 65535, no leading 0x/1x/3x/4x.

➤ **Step 4-2: Configure the Pair-Connection for the ET-2260#2 (Push Mode)**

1. Click the **Pair** tab to display the configuration page.
2. In the **Pair-Connection Setting** section, choose **PUSH** and check the box in the **Enable Mode** field to enable this mode.
3. In the **Remote IP... : Port** fields, enter the IP address and the TCP Port of the remote **ET-2260#1** module
4. In the **IO Count** field, enter the mapped quantity for DI and DO.

For example, the **PUSH Mode (Local DI to Remote DO)** configuration:
 Enter “1” in the **IO Count** field and “0” in both the **Local/Remote IO Address** fields.
 This means **DI0** of **ET-2260#2** module correspond to **DO0** of **ET-2260#1** module.

5. In the **Local IO Address** field, select “1x: Discrete Input..” and enter the starting **DI** address.
 In the **Remote IO Address** field, select “0x: Coil Output...” and enter the starting **DO** address.
6. Choose the Modbus protocol (e.g., **TCPv4**) from the **Network Protocol** drop-down menu.
7. Click the “**Submit...**” button to complete the configuration.

Model Name	ET-2260	Alias Name	#2
Firmware Version	v2.4.0 [Sep.06 2022]	MAC Address	00-0d-e0-65-e9-85
IP Address	192.168.79.100	Initial Switch	OFF
TCP Timeout (Socket Watchdog, Seconds)	180	System Timeout (Network Watchdog, Seconds)	0

Pair-Connection Settings: Submit 1-8 9-16

#	Enable Mode	Remote IPv4 / IPv6 / Host Name (Max. 127 chars) : Port	Net ID	Scan Time (ms)	IO Count	Local IO Address	Remote IO Address	Network Protocol
01	<input checked="" type="checkbox"/> PUSH	192.168.79.10 : 502	1	1000	1	1x:Disc 0	0x:Coil 0	TCPv4
02	<input type="checkbox"/> PULL	: 502	1	1000	1	0x:Coil 0	0x:Coil 0	TCPv4
03	<input type="checkbox"/> PULL	: 502	1	1000	1	0x:Coil 0	0x:Coil 0	TCPv4
04	<input type="checkbox"/> PULL	: 502	1	1000	1	0x:Coil 0	0x:Coil 0	TCPv4
05	<input type="checkbox"/> PULL	: 502	1	1000	1	0x:Coil 0	0x:Coil 0	TCPv4
06	<input type="checkbox"/> PULL	: 502	1	1000	1	0x:Coil 0	0x:Coil 0	TCPv4
07	<input type="checkbox"/> PULL	: 502	1	1000	1	0x:Coil 0	0x:Coil 0	TCPv4
08	<input type="checkbox"/> PULL	: 502	1	1000	1	0x:Coil 0	0x:Coil 0	TCPv4

Note:
 PULL Mode = Remote to Local
 PUSH Mode = Local to Remote
 Pair-connection is disabled if the IO Count is 0 (no data)
 IO Address (base 0): 0 - 65535, no leading 0x/1x/3x/4x.

5.3 Set Two Modules to Pull Mode (Remote DI to 2-Local DO)

➤ **Step 1: Connect the Module to the Network, PC, and Power Supply**

Confirm that the ET-2200 series modules are functioning correctly. Refer to [Chapter 3 “Getting Started”](#) for more details. Here is the schematic diagram for this example, utilizing the ET-2260 and ET-7255 modules.

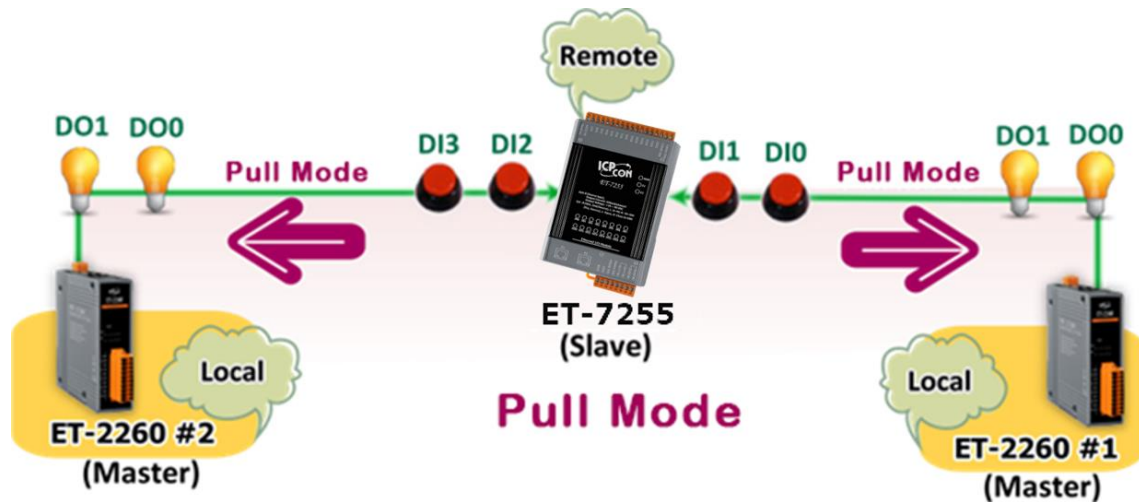

➤ **Step 2: Configure the Ethernet Settings**

Contact your network administrator to get the correct network configuration information (e.g., IP/Mask/Gateway) needed to set up I/O modules. For more instructions, refer to [Section 3.3 “Configuring the Network Settings”](#).

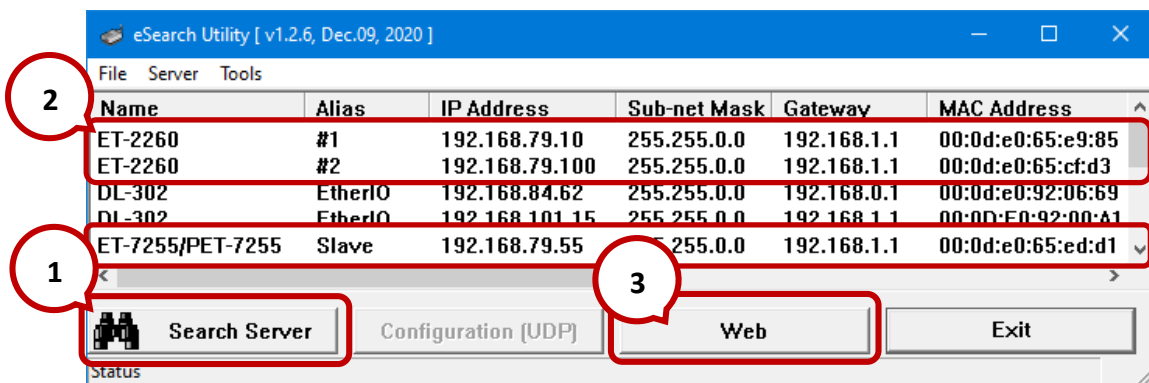

➤ **Step 3: Log into the Module’s Web Server**

1. Choose the **ET-2260#1/#2** or **ET-7255** module within the eSearch Utility and then click the **“Web”** button to open the login webpage.
2. Enter the password in the **Login password** field (**Defaults: “Admin”**) and click the **“Submit”** button to log into the Web Server. (See [Section 5.1 – Step3](#))

➤ **Step 4-1: Configure the Pair-Connection for the ET-2260#1 (Pull Mode)**

1. Click the **Pair** tab to display the configuration page.
2. In the **Pair-Connection Setting** section, choose **PULL** and check the box in the **Enable Mode** field to enable this mode.
3. In the **Remote IP... : Port** fields, enter the IP address and TCP Port of the remote **ET-7255** module.
4. In the **IO Count** field, enter the mapped quantity for DI and DO.

For example, the **PULL Mode (Remote DI to Local DO)** configuration:

Enter “2” in the “IO Count” field and “0” in both the **Local/Remote IO Address** fields. This means **DI0** and **DI1** of **ET-7255** module correspond to **DO0** and **DO1** of **ET-2260#1** module.

5. In the **Local IO Address** field, select “0x: Coil Output...” and enter the starting **DO** address. In the **Remote IO Address** field, select “1x: Discrete Input...” and enter the starting **DI** address.
6. Choose the Modbus protocol (e.g., **TCPv4**) from the **Network Protocol** drop-down menu.
7. Click the “**Submit...**” button to complete the configuration.

Model Name	ET-2260	Alias Name	#1
Firmware Version	v2.4.0 [Sep.06 2022]	MAC Address	00-0d-e0-65-cf-d3
IP Address	192.168.79.10	Initial Switch	OFF
TCP Timeout (Socket Watchdog, Seconds)	180	System Timeout (Network Watchdog, Seconds)	0

Pair-Connection Settings: Submit 1-8 9-16 |

#	Enable Mode	Remote IPv4 / IPv6 / Host Name (Max. 127 chars) : Port	Net ID	Scan Time (ms)	IO Count	Local IO Address	Remote IO Address	Network Protocol
0	<input checked="" type="checkbox"/> PULL	192.168.79.55 : 502	1	1000	2	0x:Coil 0	1x:Disc 0	TCPv4
02	<input type="checkbox"/> PULL		1	1000	1	0x:Coil 0	0x:Coil 0	TCPv4
03	<input type="checkbox"/> PULL		1	1000	1	0x:Coil 0	0x:Coil 0	TCPv4
04	<input type="checkbox"/> PULL		1	1000	1	0x:Coil 0	0x:Coil 0	TCPv4
05	<input type="checkbox"/> PULL		1	1000	1	0x:Coil 0	0x:Coil 0	TCPv4
06	<input type="checkbox"/> PULL		1	1000	1	0x:Coil 0	0x:Coil 0	TCPv4
07	<input type="checkbox"/> PULL		1	1000	1	0x:Coil 0	0x:Coil 0	TCPv4
08	<input type="checkbox"/> PULL		1	1000	1	0x:Coil 0	0x:Coil 0	TCPv4

Note:
 PULL Mode = Remote to Local
 PUSH Mode = Local to Remote
 Pair-connection is disabled if the IO Count is 0 (no data)
 IO Address (base 0): 0 - 65535, no leading 0x/1x/3x/4x.

➤ **Step 4-2: Configure the Pair-Connection for the ET-2260#2 (Pull Mode)**

1. Click the **Pair** tab to display the configuration page.
2. In the **Pair-Connection Setting** section, choose **PULL** and check the box in the **Enable Mode** field to enable this mode.
3. In the **Remote IP... : Port** fields, enter the IP address and TCP Port of the remote **ET-7255** module.
4. In the **IO Count** field, enter the mapped quantity for DI and DO.

For example, the **PULL Mode (Remote DI to Local DO)** configuration:

Enter “**2**” in the “**IO Count**” field and “**0/ 2**” in both the **Local/Remote IO Address** fields. This means **DI2** and **DI3** of **ET-7255** module correspond to **DO0** and **DO1** of **ET-2260#2** module.

5. In the **Local IO Address** field, select “0x: Coil Output...” and enter the starting **DO** address. In the **Remote IO Address** field, select “1x: Discrete Input...” and enter the starting **DI** address.
6. Choose the Modbus protocol (e.g., **TCPv4**) from the **Network Protocol** drop-down menu.
7. Click the “**Submit...**” button to complete the configuration.

Model Name	ET-2260	Alias Name	#2
Firmware Version	v2.4.0 [Sep.06 2022]	MAC Address	00-0d-e0-65-e9-85
IP Address	192.168.79.100	Initial Switch	OFF
TCP Timeout (Socket Watchdog, Seconds)	180	System Timeout (Network Watchdog, Seconds)	0

Pair-Connection Settings: Submit 1-8 9-16 |

#	Enable Mode	Remote IPv4 / IPv6 / Host Name (Max. 127 chars) : Port	Net ID	Scan Time (ms)	IO Count	Local IO Address	Remote IO Address	Network Protocol
01	<input checked="" type="checkbox"/> PULL	192.168.79.55 : 502	1	1000	2	0x:Coil 0	1x:Dis 2	TCPv4
02	<input type="checkbox"/> PULL	: 502	1	1000	1	0x:Coil 0	0x:Coil 0	TCPv4
03	<input type="checkbox"/> PULL	: 502	1	1000	1	0x:Coil 0	0x:Coil 0	TCPv4
04	<input type="checkbox"/> PULL	: 502	1	1000	1	0x:Coil 0	0x:Coil 0	TCPv4
05	<input type="checkbox"/> PULL	: 502	1	1000	1	0x:Coil 0	0x:Coil 0	TCPv4
06	<input type="checkbox"/> PULL	: 502	1	1000	1	0x:Coil 0	0x:Coil 0	TCPv4
07	<input type="checkbox"/> PULL	: 502	1	1000	1	0x:Coil 0	0x:Coil 0	TCPv4
08	<input type="checkbox"/> PULL	: 502	1	1000	1	0x:Coil 0	0x:Coil 0	TCPv4

Note:
 PULL Mode = Remote to Local
 PUSH Mode = Local to Remote
 Pair-connection is disabled if the IO Count is 0 (no data)
 IO Address (base 0): 0 - 65535, no leading 0x/1x/3x/4x.

5.4 Set Two Modules to Push Mode (2-Local DI to Remote DO)

➤ Step 1: Connect the Module to the Network, PC, and Power Supply

Confirm that the ET-2200 series modules are functioning correctly. Refer to [Chapter 3 “Getting Started”](#) for more details. Here is the schematic diagram for this example, utilizing the ET-2260 and ET-7255 modules.

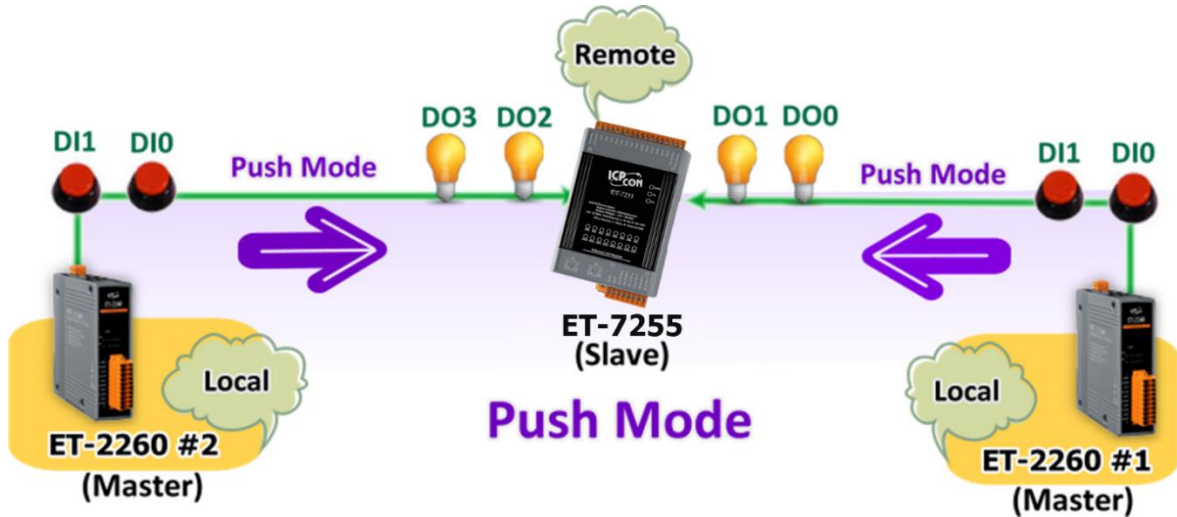

➤ Step 2: Configure the Ethernet Settings

Contact your network administrator to get the correct network configuration information (e.g., IP/Mask/Gateway) needed to set up I/O modules. For more instructions, refer to [Section 3.3 “Configuring the Network Settings”](#).

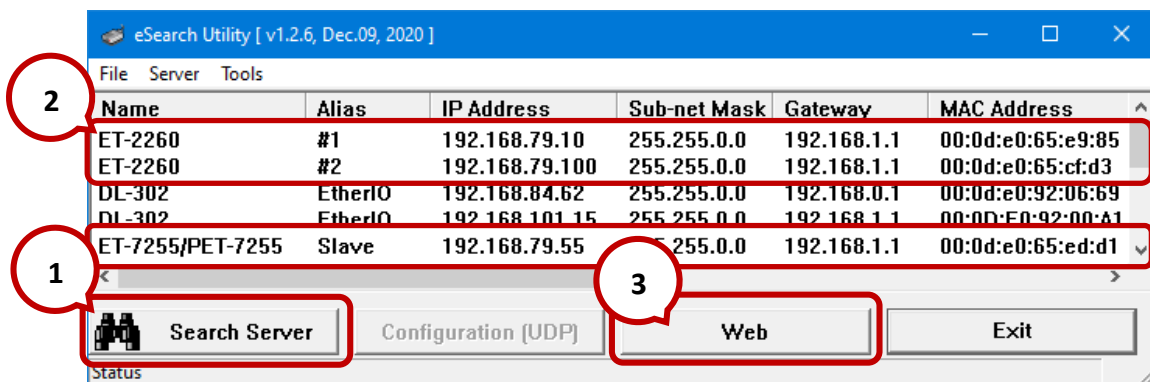

➤ Step 3: Log into the Module’s Web Server

3. Choose the **ET-2260#1/#2** or **ET-7255** module within the eSearch Utility and then click the **“Web”** button to open the login webpage.
4. Enter the password in the **Login password** field (**Defaults: “Admin”**) and click the **“Submit”** button to log into the Web Server. (See [Section 5.1 – Step3](#))

➤ **Step 4-1: Configure the Pair-Connection for the ET-2260#1 (Push Mode)**

1. Click the **Pair** tab to display the configuration page.
2. In the **Pair-Connection Setting** section, choose **PUSH** and check the box in the **Enable Mode** field to enable this mode.
3. In the **Remote IP... : Port** fields, enter the IP address and the TCP Port of the remote **ET-7255** module
4. In the **IO Count** field, enter the mapped quantity for DI and DO.

For example, the **PUSH Mode (Local DI to Remote DO)** configuration:
 Enter “2” in the **IO Count** field and “0” in both the **Local/Remote IO Address** fields. This means **DI0, DI1** of ET-2260#1 module correspond to **DO0, DO1** of ET-7255 module.

5. In the **Local IO Address** field, select “1x: Discrete Input..” and enter the starting **DI** address. In the **Remote IO Address** field, select “0x: Coil Output...” and enter the starting **DO** address.
6. Choose the Modbus protocol (e.g., **TCPv4**) from the **Network Protocol** drop-down menu.
7. Click the “**Submit...**” button to complete the configuration.

<table border="1" style="width: 100%; border-collapse: collapse;"> <tr><td>Model Name</td><td>ET-2260</td></tr> <tr><td>Firmware Version</td><td>v2.4.0 [Sep.06 2022]</td></tr> <tr><td>IP Address</td><td>192.168.79.10</td></tr> <tr><td>TCP Timeout (Socket Watchdog, Seconds)</td><td>180</td></tr> </table>	Model Name	ET-2260	Firmware Version	v2.4.0 [Sep.06 2022]	IP Address	192.168.79.10	TCP Timeout (Socket Watchdog, Seconds)	180	<table border="1" style="width: 100%; border-collapse: collapse;"> <tr><td>Alias Name</td><td>#1</td></tr> <tr><td>MAC Address</td><td>00-0d-e0-65-cf-d3</td></tr> <tr><td>Initial Switch</td><td>OFF</td></tr> <tr><td>System Timeout (Network Watchdog, Seconds)</td><td>0</td></tr> </table>	Alias Name	#1	MAC Address	00-0d-e0-65-cf-d3	Initial Switch	OFF	System Timeout (Network Watchdog, Seconds)	0
Model Name	ET-2260																
Firmware Version	v2.4.0 [Sep.06 2022]																
IP Address	192.168.79.10																
TCP Timeout (Socket Watchdog, Seconds)	180																
Alias Name	#1																
MAC Address	00-0d-e0-65-cf-d3																
Initial Switch	OFF																
System Timeout (Network Watchdog, Seconds)	0																
Pair-Connection Settings: Submit 1-8 9-16																	
#	Enable Mode	Remote IPv4 / IPv6 / Host Name (Max. 127 chars) : Port	Net ID	Scan Time (ms)	IO Count	Local IO Address	Remote IO Address	Network Protocol									
01	<input checked="" type="checkbox"/> PUSH	192.168.79.55 : 502	1	1000	2	1x:Disc 0	0x:Coil 0	TCPv4									
02	<input type="checkbox"/> PULL	: 502	1	1000	1	0x:Coil 0	0x:Coil 0	TCPv4									
03	<input type="checkbox"/> PULL	: 502	1	1000	1	0x:Coil 0	0x:Coil 0	TCPv4									
04	<input type="checkbox"/> PULL	: 502	1	1000	1	0x:Coil 0	0x:Coil 0	TCPv4									
05	<input type="checkbox"/> PULL	: 502	1	1000	1	0x:Coil 0	0x:Coil 0	TCPv4									
06	<input type="checkbox"/> PULL	: 502	1	1000	1	0x:Coil 0	0x:Coil 0	TCPv4									
07	<input type="checkbox"/> PULL	: 502	1	1000	1	0x:Coil 0	0x:Coil 0	TCPv4									
08	<input type="checkbox"/> PULL	: 502	1	1000	1	0x:Coil 0	0x:Coil 0	TCPv4									
<p>Note: PULL Mode = Remote to Local PUSH Mode = Local to Remote Pair-connection is disabled if the IO Count is 0 (no data) IO Address (base 0): 0 - 65535, no leading 0x/1x/3x/4x.</p>																	

➤ **Step 4-2: Configure the Pair-Connection for the ET-2260#2 (Push Mode)**

1. Click the **Pair** tab to display the configuration page.
2. In the **Pair-Connection Setting** section, choose **PUSH** and check the box in the **Enable Mode** field to enable this mode.
3. In the **Remote IP... : Port** fields, enter the IP address and the TCP Port of the remote **ET-7255** module
4. In the **IO Count** field, enter the mapped quantity for DI and DO.

For example, the **PUSH Mode (Local DI to Remote DO)** configuration:
 Enter “2” in the **IO Count** field and “0 / 2” in both the **Local/Remote IO Address** fields.
 This means **DI0, DI1** of **ET-2260#2** module correspond to **DO2, DO3** of **ET-7255** module.

5. In the **Local IO Address** field, select “1x: Discrete Input..” and enter the starting **DI** address.
 In the **Remote IO Address** field, select “0x: Coil Output...” and enter the starting **DO** address.
6. Choose the Modbus protocol (e.g., **TCPv4**) from the **Network Protocol** drop-down menu.
7. Click the “**Submit...**” button to complete the configuration.

Model Name	ET-2260	Alias Name	#2
Firmware Version	v2.4.0 [Sep.06 2022]	MAC Address	00-0d-e0-65-e9-85
IP Address	192.168.79.100	Initial Switch	OFF
TCP Timeout (Socket Watchdog, Seconds)	180	System Timeout (Network Watchdog, Seconds)	0

Pair-Connection Settings: Submit 1-8 9-16 |

#	Enable Mode	Remote IPv4 / IPv6 / Host Name (Max. 127 chars) : Port	Net ID	Scan Time (ms)	IO Count	Local IO Address	Remote IO Address	Network Protocol
01	<input checked="" type="checkbox"/> PUSH	192.168.79.55 : 502	1	1000	2	1x:Discrete Input 0	0x:Coil Output 2	TCPv4
02	<input type="checkbox"/> PULL	: 502	1	1000	1	0x:Coil Output 0	0x:Coil Output 0	TCPv4
03	<input type="checkbox"/> PULL	: 502	1	1000	1	0x:Coil Output 0	0x:Coil Output 0	TCPv4
04	<input type="checkbox"/> PULL	: 502	1	1000	1	0x:Coil Output 0	0x:Coil Output 0	TCPv4
05	<input type="checkbox"/> PULL	: 502	1	1000	1	0x:Coil Output 0	0x:Coil Output 0	TCPv4
06	<input type="checkbox"/> PULL	: 502	1	1000	1	0x:Coil Output 0	0x:Coil Output 0	TCPv4
07	<input type="checkbox"/> PULL	: 502	1	1000	1	0x:Coil Output 0	0x:Coil Output 0	TCPv4
08	<input type="checkbox"/> PULL	: 502	1	1000	1	0x:Coil Output 0	0x:Coil Output 0	TCPv4

Note:
 PULL Mode = Remote to Local
 PUSH Mode = Local to Remote
 Pair-connection is disabled if the IO Count is 0 (no data)
 IO Address (base 0): 0 - 65535, no leading 0x/1x/3x/4x.

5.5 Shared Memory

The ET-2200 DIO series add a 512-byte shared memory which can be used as a tiny data concentrator to store both the AIO and DIO data (256 Registers or 4096-bit shared single memory).

Shared memory used with the Pair-Connection function can effectively lower the host load. It can also perform Bits/Registers data exchange, i.e., read data from the remote device and store them in the memory or output signals from the memory to the remote device.

Note: Shared memory is only available for the firmware v2.4.0 and later. The older version is not supported.

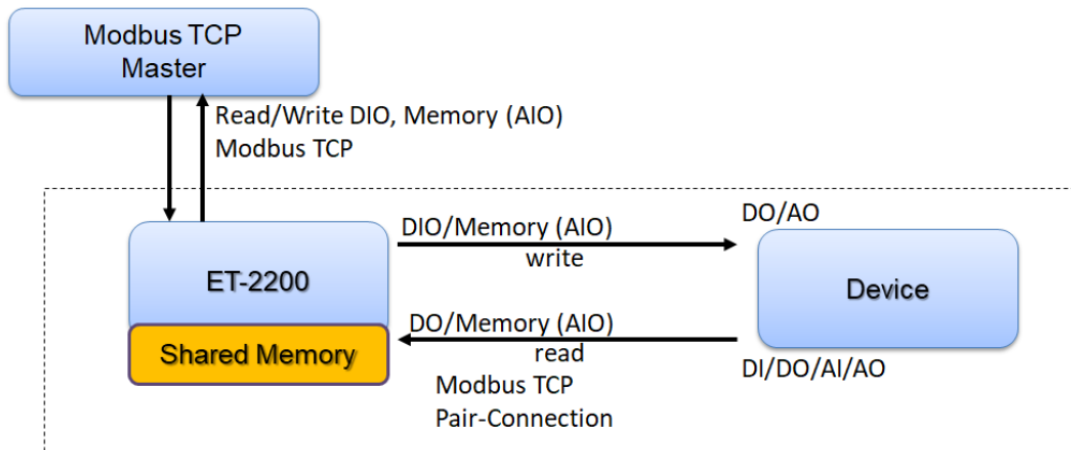

5.5.1 Address Mapping for Shared Memory

Shared Memory Register Name	3x, 4x (AIO) Register Address	Mapping (=)	Shared Memory Bit Name	0x, 1x (DIO) Bit Address
Register 0	3000	↔	Bit 0 ... Bit 15	3000 ... 3015
Register 1	3001	↔	Bit 16 ... Bit 31	3016 ... 3031
Register 2	3002	↔	Bit 32 ... Bit 47	3032 ... 3047
Register 3	3003	↔	Bit 48 ... Bit 63	3048 ... 3063
Register 4	3004	↔	Bit 64 ... Bit 79	3064 ... 3079
Register 5	3005	↔	Bit 80 ... Bit 95	3080 ... 3095
Register 6	3006	↔	Bit 96 ... Bit 111	3096 ... 3111
Register 7	3007	↔	Bit 112 ... Bit 127	3112 ... 3127
Register 8	3008	↔	Bit 128 ... Bit 143	3128 ... 3143
Register 9	3009	↔	Bit 144 ... Bit 159	3144 .. 3159
Register 10	3010	↔	Bit 160 ... Bit 175	3160 ... 3175
...				

Note: All DI, DO, AI, and AO signals shared a single memory space. The storage address starts at 3000.

Writing 16 bits of DI/DO data to addresses 3000 – 3015 is equivalent to writing one 16-bit AI/AO register to the address 3000.

Writing 16 bits of DI/DO data to addresses 3016 – 3031 is equivalent to writing one 16-bit AI/AO register to the address 3001.

The correspondence of addresses is as follows, using the division to take the quotient and remove the remainder.

$$14) \text{ AIO_Address} = (\text{DIO_Address} - 3000) / 16 + 3000$$

5.5.2 Application of spreading the load (DIO)

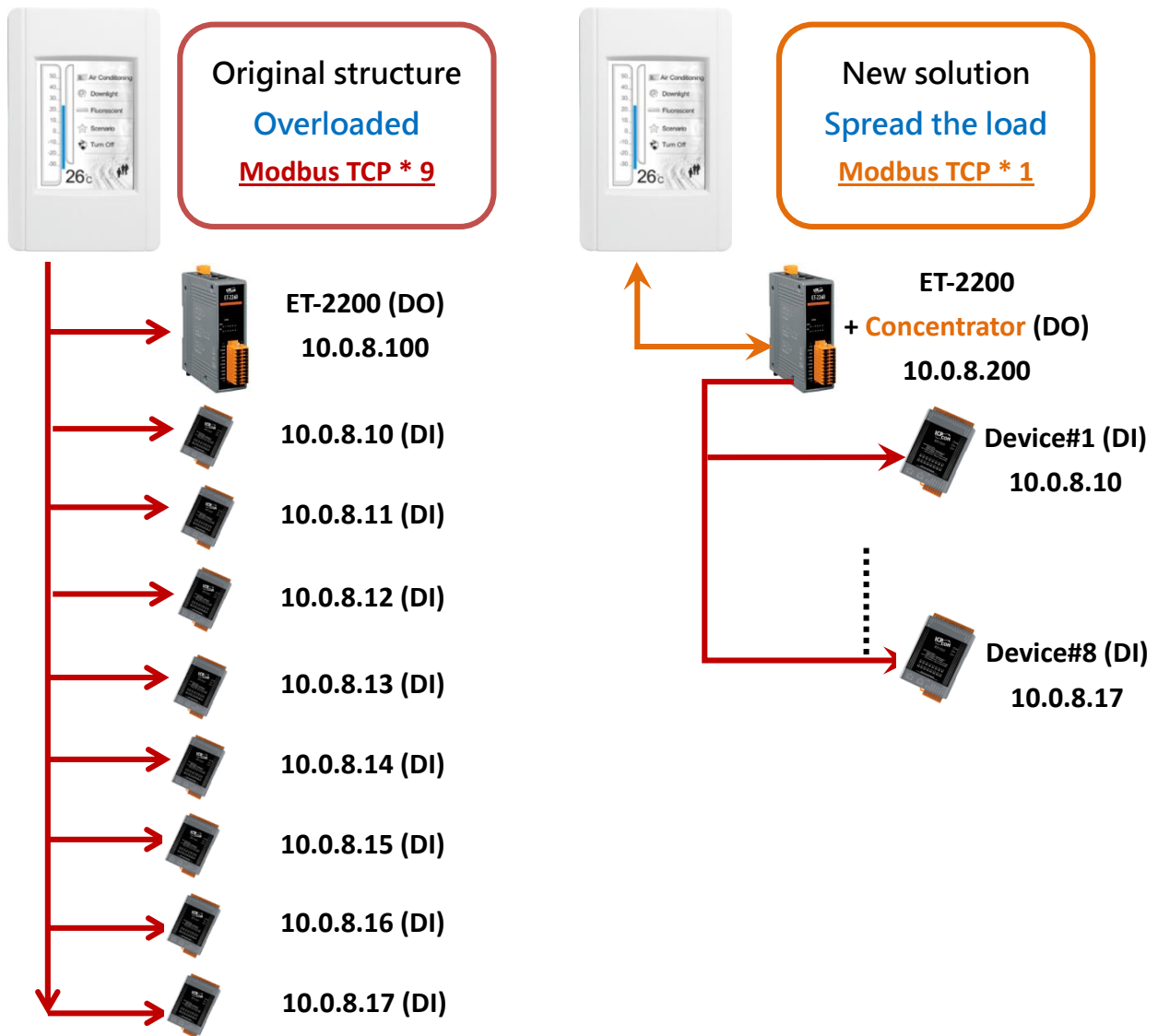

The original architecture on the left does not use the data concentrator feature, the host has to connect with all devices to exchange data (9 Modbus TCP connections in this case), and more devices will make the host overloaded.

The new architecture on the right uses the data concentrator feature on the ET-2200 series DIO module. The Pair-connection function supports up to **16** IP connections. The host can obtain the signals written in the data concentrator from Device#1 - #8 by connecting to the ET-2200 series DIO module. The number of Modbus TCP connections to the host is reduced from 9 to 1, which can effectively spread the load.

Host	ET-2200 + Concentrator IP	Remote IP (Slave #1-8)	IO Address (Shared Memory)
	<p>10.0.8.200</p>	10.0.8.10	3000...3015
		10.0.8.11	3016...3031
		10.0.8.12	3032...3047
		10.0.8.13	3048...3063
		10.0.8.14	3064...3079
		10.0.8.15	3080...3095
		10.0.8.16	3096...3111
		10.0.8.17	3112...3127

Refer to Chapter 5 - I/O Pair Connection Application for detailed configuration

1. Click **Enable Mode** and choose the **PULL** mode (Remote DI to Local DO) to enable this function (#01 ~ #08).
2. In the **Remote IP... : Port** field, enter the IP address and TCP port (502) of remote modules (Slave #1-8). In the **IO Count** field, enter the number of mapped DI (e.g., 16). In the **Local IO Address** field, select “0x: Coil Output...” and enter the starting address of the shared memory. In the **Remote IO Address** field, select “1x: Discrete Input...” and enter the starting DI address.
3. In Shared Memory, the host computer has the option to use either Bit or Register addresses to poll ET-2200, and both approaches can read the same data. Accessing a Register is equivalent to accessing 16 bits.

Pair-Connection Settings: | | 9-16 |

#	Enable Mode	Remote IPv4 / IPv6 / Host Name (Max. 127 chars) : Port	Net ID	Scan Time (ms)	IO Count	Local IO Address	Remote IO Address	Network Protocol
01	<input checked="" type="checkbox"/> PULL	10.0.8.10 : 502	1	1000	16	0x:Coil O 3000	1x:Discre 0	TCPv4
02	<input checked="" type="checkbox"/> PULL	10.0.8.11 : 502	1	1000	16	0x:Coil O 3016	1x:Discre 0	TCPv4
03	<input checked="" type="checkbox"/> PULL	10.0.8.12 : 502	1	1000	16	0x:Coil O 3032	1x:Discre 0	TCPv4
04	<input checked="" type="checkbox"/> PULL	10.0.8.13 : 502	1	1000	16	0x:Coil O 3048	1x:Discre 0	TCPv4
05	<input checked="" type="checkbox"/> PULL	10.0.8.14 : 502	1	1000	16	0x:Coil O 3064	1x:Discre 0	TCPv4
06	<input checked="" type="checkbox"/> PULL	10.0.8.15 : 502	1	1000	16	0x:Coil O 3080	1x:Discre 0	TCPv4
07	<input checked="" type="checkbox"/> PULL	10.0.8.16 : 502	1	1000	16	0x:Coil O 3096	1x:Discre 0	TCPv4
08	<input checked="" type="checkbox"/> PULL	10.0.8.17 : 502	1	1000	16	0x:Coil O 3112	1x:Discre 0	TCPv4

Note:
 PULL Mode = Remote to Local
 PUSH Mode = Local to Remote
 Pair-connection is disabled if the IO Count is 0 (no data)
 IO Address (base 0): 0 - 65535, no leading 0x/1x/3x/4x.

5.5.3 Example of Using Memory AIO

The example will show you how to read data from a remote AI module and then write data to the shared memory (AO) of the DO module.

Remote IP PET-2217 (AI)	Local IP ET-2260 (DO)	Memory AO Address
192.68.79.17	192.68.79.60	3000...3003

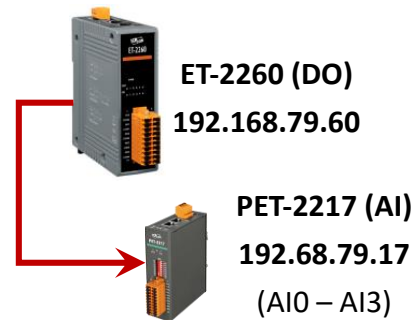

Configure the following settings on the Pair page of the ET-2260 module.

1. Click **Enable Mode** and choose the **PULL** mode (**Remote AI to Local AO**) to enable this function.
2. In the **Remote IP... : Port** field, enter the IP address and TCP port (502) of the **PET-2217**.
In the **IO Count** field, enter the number of mapped AI/AO. (E.g., 4)
In the **Local IO Address** field, select “4x: Holding Register/...” and enter the starting address of the shared memory (AO). (E.g., 3000).
In the **Remote IO Address** field, select “3x: Input Register/...” and enter the starting AI address. (E.g., 0).
3. Click the “**Submit...**” button to complete the configuration.

Ethernet I/O Module
[Home](#) | [Network](#) | [I/O Settings](#) | [Sync](#) | [PWM](#) | [Pair](#) | [Filter](#) | [Monitor](#) | [Password](#) | [Logout](#)
 MQTT (Topics: DO | DI) | SNMP

Model Name	ET-2260	Alias Name	DIO
Firmware Version	V2.4.0 [Sep.06 2022]	MAC Address	00-0d-e0-65-e9-85
IP Address	192.168.79.60	Initial Switch	OFF
TCP Timeout (Socket Watchdog, Seconds)	180	System Timeout (Network Watchdog, Seconds)	0

Pair-Connection Settings: [Submit 1-8](#) | [9-16](#) |

#	Enable Mode	Remote IPv4 / IPv6 / Host Name (Max. 127 chars) : Port	Net ID	Scan Time (ms)	IO Count	Local IO Address	Remote IO Address	Network Protocol
01	<input checked="" type="checkbox"/> PULL	192.168.79.17 : 502	1	1000	4	4x:Hold 3000	3x:Input 0	TCPv4

4. To read data in shared memory by using the **Modbus Master Tool**.

https://www.icpdas.com/tw/product/guide+Software+Development__Tools+Modbus__Tool#674

Modbus Master Tool V1.1.5.0 2021/06/04D:\tool\ModbusMasterToolPC

File Setup Connection Window About

- Definition
- New Window
- Set Value
- Set Description

Download it on www.icpdas.com

- Select either AI or AO in the **Type** field; the readings will be the same. Set the starting address to **“3000”** and read **four** values.

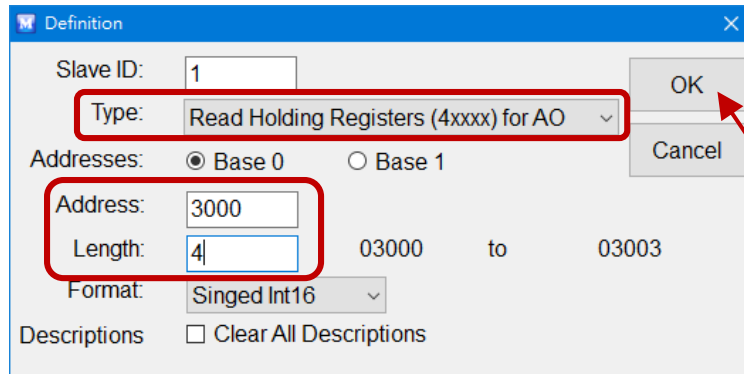

- Select **“Connection > Connect”** and enter the ET-2260’s IP address, and then click **OK**.

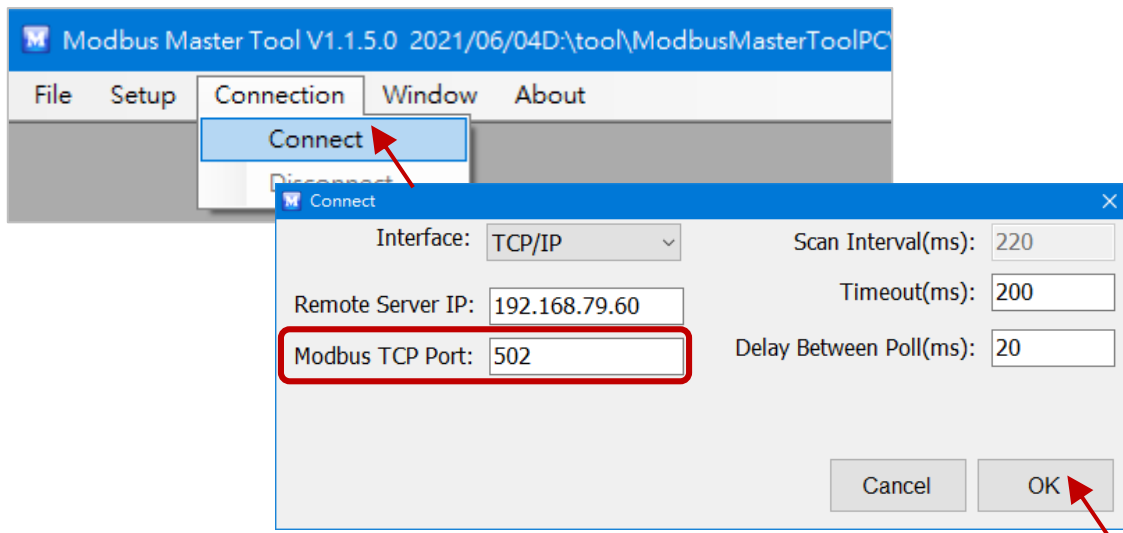

- The user can view the values stored in **addresses 3000 to 3003** within the Shared Memory of **ET-2260**. Additionally, you can verify the data by checking the **Home** page of **PET-2117**.

The screenshot shows the Modbus Master Tool interface. On the left, the 'Master0' window displays a table of AO (Analog Output) values for addresses 3000 to 3003. The values are circled in red:

Address	Value	Description
3000 (0xBB8)	8493	
3001 (0xBB9)	7493	
3002 (0xBBA)	6196	
3003 (0xBBB)	9991	

On the right, the 'Ethernet I/O Module' configuration page for P/ET-2217 is shown. The 'Home' link in the navigation bar is circled in red. The 'Modbus Format' is set to 'Engineering' and the 'Analog Input Mode' is 'Differential'. Below this, the 'Analog Input (Modbus Address: AI=30000 ~)' table is displayed:

AI Channel	Value (30000~)	Type (40427~)	Channel Enable (00595~)
AI0:	8.494	0x08:-10 ~ +10V	Enabled
AI1:	7.496	0x08:-10 ~ +10V	Enabled
AI2:	6.197	0x08:-10 ~ +10V	Enabled
AI3:	9.993	0x08:-10 ~ +10V	Enabled
AI4:	0.000	0x08:-10 ~ +10V	Disabled

5.5.4 Master/Slave/MTCP/MUDP Data Exchange

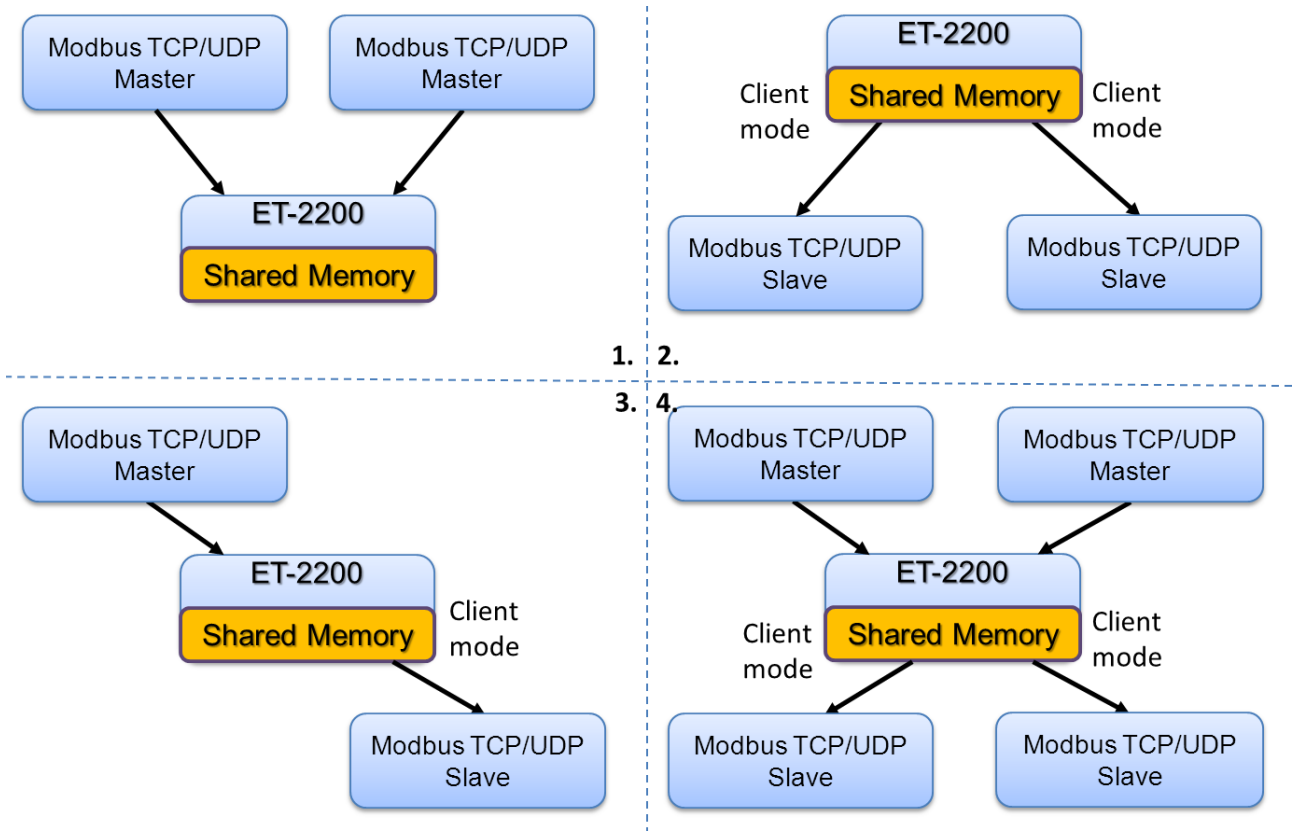

1. Two hosts can exchange data via shared memory.
2. With the Pair-connection function, two Slave devices can also exchange data via shared memory.
3. With the Pair-connection function, the host can indirectly control the Slave device via the shared memory.
4. Shared memory can be used as a concentrator for multiple hosts and Slave devices to exchange data.

5.5.5 Bits / Registers Data Exchange

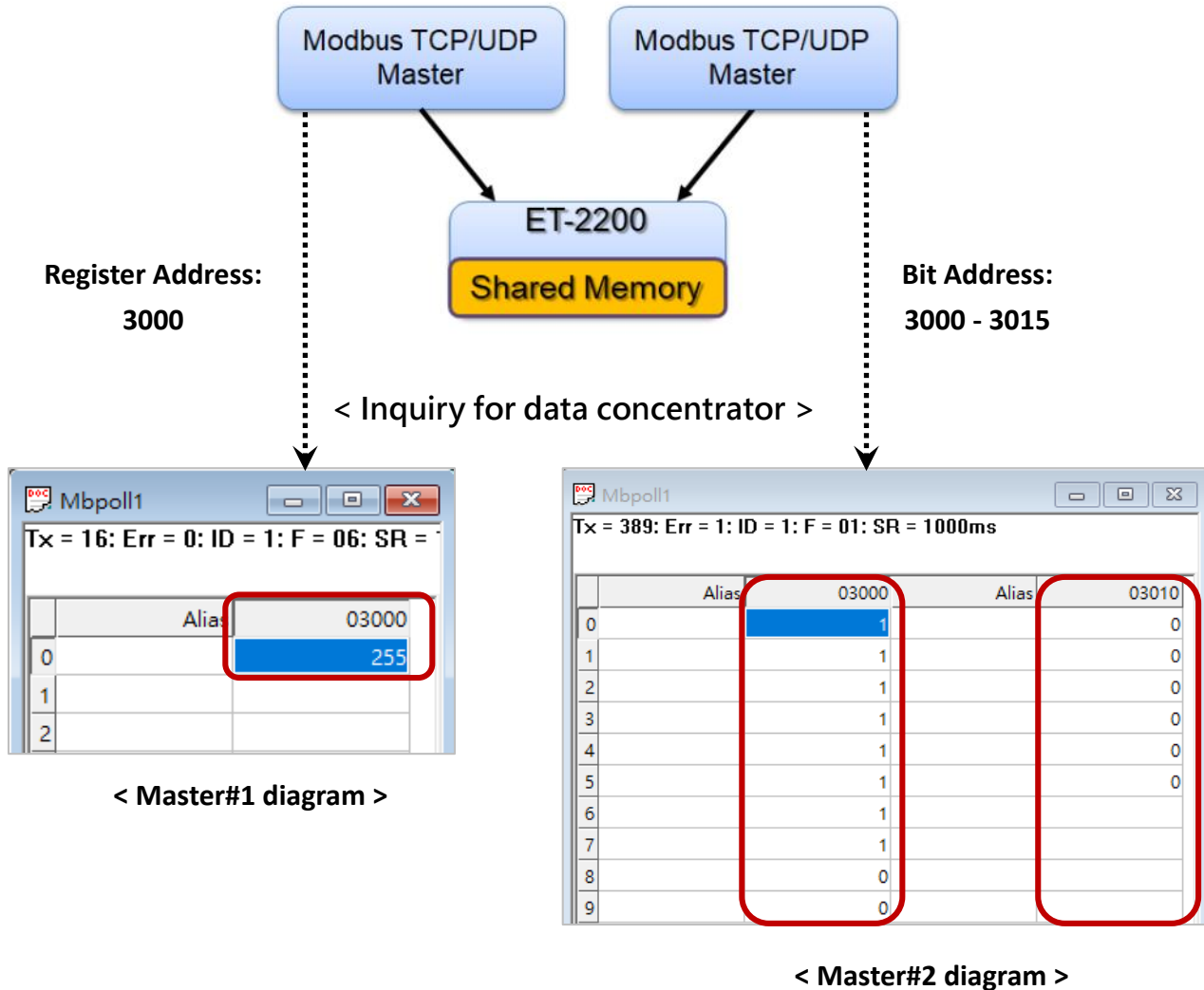

Generally, the device cannot exchange the Bit and Register data directly, but this can achieve by using the shared memory of ET-2200 as a concentrator. As the diagram above, the Modbus Master#1 writes data **255 (0X00FF)** to the shared memory with a Register address **3000**. The Modbus Master#2 reads data from the shared memory with Bit addresses **3015 to 3000** and gets the result **0000 0000 1111 1111**.

The data stored in shared memory can be read with the Bit or Register address.

6. Modbus Information

The ET-2200 series is a family of IP-based Modbus I/O devices that allow you to remotely control DI/DO terminals via an Ethernet connection and uses a master-slave communication technique in which only one device (the master) can initiate a transaction (called queries), while other devices (slaves) respond by either supplying the requested data to the master or by taking the action requested in the query.

Most SCADA (Supervisory Control and Data Acquisition) and HMI software, such as Citect (Schneider Electric), ICONICS, iFIX, InduSoft, Intouch, Entivity Studio, Entivity Live, Entivity VLC, Trace Mode, Wizcon (EIUTIONS), and Wonderware, etc. can be used to easily integrate serial devices via the Modbus protocol.

6.1 What is Modbus TCP/IP?

Modbus is a communication protocol that was developed by Modicon Inc. in 1979. Detailed information regarding the Modbus protocol can be found at: <http://www.modbus.org>.

The different versions of the Modbus protocol used today include Modbus RTU, which is based on serial communication interfaces such as RS-485 and RS-232, as well as Modbus ASCII and Modbus TCP, which uses the Modbus RTU protocol embedded into TCP packets.

Modbus TCP is an internet protocol. The protocol embeds a Modbus frame into a TCP frame so that a connection-oriented approach is obtained, thereby making it more reliable. The master queries the slave and the slave responds with a reply. The protocol is open and, hence, highly scalable.

6.2 Modbus Message Structure

Modbus devices communicate using a master-slave (client-server) technique in which only one device (the master/client) can initiate transactions (called queries). The other devices (slaves/servers) respond by either supplying the requested data to the master or by taking the action requested in the query.

A query from a master will consist of a slave, or broadcast, address, a function code defining the requested action, any required data, and an error-checking field. A response from a slave consists of fields confirming the action taken, any data to be returned, and an error-checking field.

➤ The Modbus/TCP Message Structure

Bytes 00 - 05	Bytes 06 - 11
6-byte header	RTU Data

➤ The Leading 6 bytes of a Modbus/TCP Protocol Query

Byte 00	Byte 01	Byte 02	Byte 03	Byte 04	Byte 05
Transaction Identifier		Protocol Identifier		Length Field (upper byte)	Length Field (lower byte)

- ✓ **Transaction identifier** = Assigned by the Modbus/TCP master (client)
- ✓ Protocol identifier = 0
- ✓ **Length field (upper byte)** = 0 (since all messages are smaller than 256)
- ✓ **Length field (lower byte)** = The number of following RTU data bytes

➤ Modbus RTU Data Structure

Byte 06	Byte 07	Bytes 08 - 09	Bytes 10 - 11
Net ID (Station Number)	Function Code	Data Field	
		Reference Number (Address Mapping)	Number of Points

- ✓ **Net ID:** Specifies the address of the receiver (i.e., the Modbus/TCP slave).
- ✓ **Function Code:** Specifies the message type.
- ✓ **Data Field:** The data block.

Net ID (Station Number)

The first byte in the frame structure of a Modbus RTU query is the address of the receiver. A valid address is in the range of 0 to 247. Address 0 is used for general broadcast purposes, while addresses 1 to 247 are assigned to individual Modbus devices.

Function Code

The second byte in the message structure of a Modbus RTU query is the function code, which describes what the slave device is required to do. Valid function codes range between 1 and 255. To answer the query, the slave device uses the same function code as contained in the request. The highest bit of the function code will only be set to '1' if an error occurs in the system. In this way, the master device will know whether or not the message has been correctly transmitted.

Code	Function	Reference (Address)
01 (0x01)	Read the Status of the Coils (Read DO Readback values)	0xxxx
02 (0x02)	Read the Status of the Input (Read DI values)	1xxxx
03 (0x03)	Read the Holding Registers (Read AO Readback values)	4xxxx
04 (0x04)	Read the Input Registers (Read AI values)	3xxxx
05 (0x05)	Force a Single Coil (Write DO value)	0xxxx
06 (0x06)	Set a Single Register (Write AO value)	4xxxx
15 (0x0F)	Force Multiple Coils (Write DO values)	0xxxx
16 (0x10)	Set Multiple Registers (Write AO values)	4xxxx

Data Field

Data is transmitted in 8-, 16- and 32-bit formats. The data for 16-bit registers is transmitted in high-byte first format. For example, 0x0A0B will be transmitted as 0x0A, 0x0B. The data for 32-bit registers is transmitted as two 16-bit registers and is low-word first. For example: 0x0A0B0C0D will be transmitted as 0x0C, 0x0D, 0x0A, 0x0B.

The data field for messages sent between a master device and a slave device contains additional information about the action to be taken by the master, or any information requested by the slave. If the master does not require this information, the data field can be empty.

Reference (Address)	Description
0xxxx	<p><u>Read/Write Discrete Outputs or Coils.</u></p> <p>An 0x reference address is used to output device data to a Digital Output channel.</p>
1xxxx	<p><u>Read Discrete Inputs.</u></p> <p>The ON/OFF status of a 1x reference address is controlled by the corresponding Digital Input channel.</p>
3xxxx	<p><u>Read Input Registers.</u></p> <p>A 3x reference register contains a 16-bit value received from an external source, e.g. an analog signal.</p>
4xxxx	<p><u>Read/Write Outputs or Holding Registers.</u></p> <p>A 4x register is used to store 16 bits of numerical data (binary or decimal), or to send data from the CPU to an output channel.</p>



Note:

For more details regarding the address mapping, refer to [Section 6.3 \(DIO\)](#) or [Section 6.4 \(AIO\) “Modbus Register Table”](#).

6.2.1 01(0x01) Read the Status of the Coils (Read DO Readback values)

This function code is used to read either the current status of the coils or the current Digital Output readback value from the ET-2200 series module.

[Request]

Byte	Description	Size	Value
00	Net ID (Station Number)	1 Byte	1 to 247
01	Function Code	1 Byte	0x01
02-03	Starting DO Address	2 Bytes	Refer to Section 6.3 or 6.4 “Modbus Register Table” to find the address. Byte 02 = high byte Byte 03 = low byte
04-05	Number of Points (Channels)	2 Bytes	Byte 04 = high byte Byte 05 = low byte

[Response]

Byte	Description	Size	Value
00	Net ID (Station Number)	1 Byte	1 to 247
01	Function Code	1 Byte	0x01
02	Byte Count	1 Byte	Byte Count of the Response ($n = (\text{Points}+7)/8$)
03	Data	n Bytes	n= 1; Byte 03 = data bit 7 to 0 n= 2; Byte 04 = data bit 15 to 8 n= m; Byte m+2 = data bit (8m-1) to 8(m-1)

[Error Response]

Byte	Description	Size	Value
00	Net ID (Station Number)	1 Byte	1 to 247
01	Function Code	1 Byte	0x81
02	Exception Code	1 Byte	Refer to the Modbus Standard Specifications for more details

Example: Function 01 (0x01), Readback DOs

➤ Reads the Digital Output value

	[Leading 6 bytes]	[Request]
Command:	<u>01 02 00 00 00 06</u>	<u>01 01 00 00 00 02</u>
	[Leading 6 bytes]	[Response]
Response:	<u>01 02 00 00 00 04</u>	<u>01 01 01 03</u>

➤ A description of the command and response is as follows:

Command:	[Leading 6 bytes]	
	Bytes 00-03	01 02 00 00 (Message Number)
	Bytes 04-05	00 06 (Number of bytes remaining in this frame)
	[Request]	
	Byte 00	01 (Net ID)
	Byte 01	01 (Function Code)
	Byte 02-03	00 00 (Starting DO Address)
	Byte 04-05	00 02 (Number of Points)

Response:	[Leading 6 bytes]	
	Bytes 00-03	01 02 00 00 (Message Number)
	Bytes 04-05	00 04 (Number of bytes remaining in this frame)
	[Response]	
	Byte 00	01 (Net ID)
	Byte 01	01 (Function Code)
	Byte 02	01 (Byte Count of the Response)
	Byte 03	03 (Value for DO0 to DO1)

6.2.2 02(0x02) Read the Status of the Input (Read DI values)

This function code is used to read the current Digital Input value from the ET-2200 series module.

[Request]

Byte	Description	Size	Value
00	Net ID (Station Number)	1 Byte	1 to 247
01	Function Code	1 Byte	0x02
02-03	Starting DI Address	2 Bytes	Refer to Section 6.3 or 6.4 "Modbus Register Table" to find the address. Byte 02 = high byte Byte 03 = low byte
04-05	Number of Points (Channels)	2 Bytes	Byte 04 = high byte Byte 05 = low byte

[Response]

Byte	Description	Size	Value
00	Net ID (Station Number)	1 Byte	1 to 247
01	Function Code	1 Byte	0x02
02	Byte Count	1 Byte	Byte Count of Response ($n = (\text{Points} + 7) / 8$)
03	Data	n Bytes	n= 1; Byte 03 = data bit 7 to 0 n= 2; Byte 04 = data bit 15 to 8 n= m; Byte m+2 = data bit(8m-1) to 8(m-1)

[Error Response]

Byte	Description	Size	Value
00	Net ID (Station Number)	1 Byte	1 to 247
01	Function Code	1 Byte	0x82
02	Exception Code	1 Byte	Refer to the Modbus Standard Specifications for more details

Example: Function 02 (0x02), ReadDIs

➤ Reads the Digital Input value

	[Leading 6 bytes]	[Request]
Command:	<u>01 02 00 00 00 06</u>	<u>01 02 00 00 00 02</u>
	[Leading 6 bytes]	[Response]
Response:	<u>01 02 00 00 00 04</u>	<u>01 02 01 03</u>

➤ A description of the command and response is as follows:

Command:	[Leading 6 bytes]	
Bytes 00-03	01 02 00 00	(Message Number)
Bytes 04-05	00 06	(Number of bytes remaining in this frame)
	[Request]	
Byte 00	01	(Net ID)
Byte 01	02	(Function Code)
Byte 02-03	00 00	(Starting DI Address)
Byte 04-05	00 02	(Number of Points)

Response:	[Leading 6 bytes]	
Bytes 00-03	01 02 00 00	(Message Number)
Bytes 04-05	00 04	(Number of bytes remaining in this frame)
	[Response]	
Byte 00	01	(Net ID)
Byte 01	02	(Function Code)
Byte 02	01	(Byte Count of the Response)
Byte 03	03	(Value for DI0 to DI1)

6.2.3 03(0x03) Read the Holding Registers (Read AO Readback values)

This function code is used to read back either the current values in the holding registers or the Analog Output value from the ET-2200 series module. These registers are also used to store the preset values for the Digital Counter, the host watchdog timer, the module name, the TCP timeout, etc.

[Request]

Byte	Description	Size	Value
00	Net ID (Station Number)	1 Byte	1 to 247
01	Function Code	1 Byte	0x03
02-03	Starting AO Address	2 Bytes	Refer to Section 6.3 or 6.4 "Modbus Register Table" to find the address... Byte 02 = high byte ; Byte 03 = low byte
04-05	Number of 16-bit Registers (Channels)	2 Bytes	Word Count Byte 04 = high byte ; Byte 05 = low byte

[Response]

Byte	Description	Size	Value
00	Net ID (Station Number)	1 Byte	1 to 247
01	Function Code	1 Byte	0x03
02	Byte Count	1 Byte	Byte Count of the Response (n=Points x 2 Bytes)
03~	Register Values	n Bytes	Register Values n= 2; Byte 03 = high byte Byte 04 = low byte n= m; Byte m+1 = high byte Byte m+2 = low byte

[Error Response]

Byte	Description	Size	Value
00	Net ID (Station Number)	1 Byte	1 to 247
01	Function Code	1 Byte	0x83
02	Exception Code	1 Byte	Refer to the Modbus Standard Specifications for more details

Example: Function 03 (0x03), Read AOs

- Reads the name of the module for the ET-2260

	[Leading 6 bytes]	[Request]
Command:	<u>01 02 00 00 00 06</u>	<u>01 03 01 03 00 01</u>
	[Leading 6 bytes]	[Response]
Response:	<u>01 02 00 00 00 05</u>	<u>01 03 02 22 60</u>

- A description of the command and response is as follows:

Command:	[Leading 6 bytes]	
	Bytes 00-03	01 02 00 00 (Message Number)
	Bytes 04-05	00 06 (Number of bytes remaining in this frame)
	[Request]	
	Byte 00	01 (Net ID)
	Byte 01	03 (Function Code)
	Byte 02-03	01 03 (Starting AO Address)
	Byte 04-05	00 01 (Number of Points)

Response:	[Leading 6 bytes]	
	Bytes 00-03	01 02 00 00 (Message Number)
	Bytes 04-05	00 05 (Number of bytes remaining in this frame)
	[Response]	
	Byte 00	01 (Net ID)
	Byte 01	03 (Function Code)
	Byte 02	02 (Byte Count of the Response)
	Byte 03-04	22 60 (Module Name)

6.2.4 04(0x04) Read the Input Registers (Read AI values)

This function code is used to read either the input registers or the current analog input value from the ET-2200 series module. These registers are also used to store the current value for the digital counter, the number of DI channels and the number of DO channels, etc.

[Request]

Byte	Description	Size	Value
00	Net ID (Station Number)	1 Byte	1 to 247
01	Function Code	1 Byte	0x04
02-03	Starting AI Address	2 Bytes	Refer to Section 6.3 or 6.4 “Modbus Register Table” to find the address. Byte 02 = high byte Byte 03 = low byte
04-05	Number of 16-bit Registers (Channels)	2 Bytes	Word Count Byte 04 = high byte Byte 05 = low byte

[Response]

Byte	Description	Size	Value
00	Net ID (Station Number)	1 Byte	1 to 247
01	Function Code	1 Byte	0x04
02	Byte Count	1 Byte	Byte Count of the Response (n=Points x 2 Bytes)
03~	Register Values	n Bytes	Register Values n= 2; Byte 03 = high byte Byte 04 = low byte n= m; Byte m+1 = high byte Byte m+2 = low byte

[Error Response]

Byte	Description	Size	Value
00	Net ID (Station Number)	1 Byte	1 to 247
01	Function Code	1 Byte	0x84
02	Exception Code	1 Byte	Refer to the Modbus Standard Specifications for more details.

Example: Function 04 (0x04), Read AIs

- Reads the number of the DI channels on the ET-2260

	[Leading 6 bytes]	[Request]
Command:	<u>01 02 00 00 00 06</u>	<u>01 04 00 64 00 01</u>
	[Leading 6 bytes]	[Response]
Response:	<u>01 02 00 00 00 05</u>	<u>01 04 02 00 02</u>

- A description of the command and response is as follows:

Command:	[Leading 6 bytes]	
Bytes 00-03	01 02 00 00	(Message Number)
Bytes 04-05	00 06	(Number of bytes remaining in this frame)
	[Request]	
Byte 00	01	(Net ID)
Byte 01	04	(Function Code)
Byte 02-03	0064	(Starting AI Address)
Byte 04-05	00 01	(Number of 16-bit Registers)

Response:	[Leading 6 bytes]	
Bytes 00-03	01 02 00 00	(Message Number)
Bytes 04-05	00 05	(Number of bytes remaining in this frame)
	[Response]	
Byte 00	01	(Net ID)
Byte 01	04	(Function Code)
Byte 02	02	(Byte Count of the Response)
Byte 03-04	00 02	(Number of DI channels on the ET-2260)

6.2.5 05(0x05) Force a Single Coil (Write DO value)

This function code is used to set the status of a single coil or a single Digital Output value for the ET-2200 series module.

[Request]

Byte	Description	Size	Value
00	Net ID (Station Number)	1 Byte	1 to 247
01	Function Code	1 Byte	0x05
02-03	DO Address	2 Bytes	Refer to Section 6.3 or 6.4 "Modbus Register Table" to find the address. Byte 02 = high byte ; Byte 03 = low byte
04-05	Output Value	2 Bytes	0xFF 00 sets the output to ON. 0x00 00 sets the output to OFF. All other values are invalid and will not affect the coil. Byte 04 = high byte ; Byte 05 = low byte

[Response]

Byte	Description	Size	Value
00	Net ID (Station Number)	1 Byte	1 to 247
01	Function Code	1 Byte	0x05
02-03	DO Address	2 Bytes	The value is the same as Bytes 02-03 of the Request
04-05	Output Value	2 Bytes	The value is the same as Bytes 04-05 of the Request

[Error Response]

Byte	Description	Size	Value
00	Net ID (Station Number)	1 Byte	1 to 247
01	Function Code	1 Byte	0x85
02	Exception Code	1 Byte	Refer to the Modbus Standard Specifications for more details.

Example: Function 05 (0x05), Write DO

➤ Sets channel DO1 to ON

Command:	[Leading 6 bytes] <u>01 02 00 00 00 06</u>	[Request] <u>01 05 00 01 FF 00</u>
Response:	[Leading 6 bytes] <u>01 02 00 00 00 06</u>	[Response] <u>01 05 00 01 FF 00</u>

➤ A description of the command and response is as follows:

Command:	[Leading 6 bytes]	
Bytes 00-03	01 02 00 00	(Message Number)
Bytes 04-05	00 06	(Number of bytes remaining in this frame)
	[Request]	
Byte 00	01	(Net ID)
Byte 01	05	(Function Code)
Byte 02-03	0001	(DO Address)
Byte 04-05	FF 00	(Sets the output to ON)

Response:	[Leading 6 bytes]	
Bytes 00-03	01 02 00 00	(Message Number)
Bytes 04-05	00 06	(Number of bytes remaining in this frame)
	[Response]	
Byte 00	01	(Net ID)
Byte 01	05	(Function Code)
Byte 02-03	00 01	(DO Address)
Byte 04-05	FF 00	(Indicates that the DO has been set to ON)

6.2.6 06(0x06) Set a Single Register (Write AO value)

This function code is used to set a specific holding register to store the configuration values for the ET-2200 series module.

[Request]

Byte	Description	Size	Value
00	Net ID (Station Number)	1 Byte	1 to 247
01	Function Code	1 Byte	0x06
02-03	AO Address	2 Bytes	Refer to Section 6.3 or 6.4 "Modbus Register Table" to find the address. Byte 02 = high byte Byte 03 = low byte
04-05	Register Value	2 Bytes	Register Value Byte 04 = high byte Byte 05 = low byte

[Response]

Byte	Description	Size	Value
00	Net ID (Station Number)	1 Byte	1 to 247
01	Function Code	1 Byte	0x06
02-03	AO Address	2 Bytes	The value is the same as Bytes 02-03 of the Request
04-05	Register Value	2 Bytes	The value is the same as Bytes 04-05 of the Request

[Error Response]

Byte	Description	Size	Value
00	Net ID (Station Number)	1 Byte	1 to 247
01	Function Code	1 Byte	0x86
02	Exception Code	1 Byte	Refer to the Modbus Standard Specifications for more details.

Example: Function 06 (0x06), WriteAO

- Sets the system timeout to 60 seconds

	[Leading 6 bytes]	[Request]
Command:	<u>01 02 00 00 00 06</u>	<u>01 06 01 08 00 3C</u>
	[Leading 6 bytes]	[Response]
Response:	<u>01 02 00 00 00 06</u>	<u>01 06 01 08 00 3C</u>

- A description of the command and response is as follows:

Command:	[Leading 6 bytes]	
	Bytes 00-03	01 02 00 00 (Message Number)
	Bytes 04-05	00 06 (Number of bytes remaining in this frame)
	[Request]	
	Byte 00	01 (Net ID)
	Byte 01	06 (Function Code)
	Byte 02-03	0108 (AO Address)
	Byte 04-05	003C (Sets the system timeout to 60 seconds)

Response:	[Leading 6 bytes]	
	Bytes 00-03	01 02 00 00 (Message Number)
	Bytes 04-05	00 06 (Number of bytes remaining in this frame)
	[Response]	
	Byte 00	01 (Net ID)
	Byte 01	06 (Function Code)
	Byte 02-03	01 08 (AO Address)
	Byte 04-05	003C (Indicates that the system timeout has been set to 60 seconds)

6.2.7 15(0x0F) Force Multiple Coils (Write DO values)

This function code is used to set the status of multiple coils or to write multiple Digital Output values for the ET-2200 series module.

[Request]

Byte	Description	Size	Value
00	Net ID (Station Number)	1 Byte	1 to 247
01	Function Code	1 Byte	0x0F
02-03	Starting DO Address	2 Bytes	Refer to Section 6.3 or 6.4 "Modbus Register Table" to find the address. Byte 02 = high byte ; Byte 03 = low byte
04-05	Number of Output Channels (Points)	2 Bytes	Byte 04 = high byte ; Byte 05 = low byte
06	Byte count	1 Byte	$n = (\text{Points} + 7) / 8$
07	Output value	n Bytes	A bit corresponds to a channel. A value of 1 for a bit denotes that the channel is ON, while a value of 0 denotes that the channel is OFF. n= 1; Byte 07 = data bit 7 to 0 n= 2; Byte 08 = data bit 15 to 8 n= m; Byte m+6 = data bit (8m-1) to 8 (m-1)

[Response]

Byte	Description	Size	Value
00	Net ID (Station Number)	1 Byte	1 to 247
01	Function Code	1 Byte	0x0F
02-03	Starting DO Address	2 Bytes	The value is the same as Bytes 02-05 of the Request
04-05	Number of Output Channels (Points)	2 Bytes	

[Error Response]

Byte	Description	Size	Value
00	Net ID (Station Number)	1 Byte	1 to 247
01	Function Code	1 Byte	0x8F
02	Exception Code	1 Byte	Refer to the Modbus Standard Specifications for more details.

Example: Function 15 (0x0F), Write DOs

➤ Sets the safe value (DO0 ~ DO1)

	[Leading 6 bytes]	[Request]
Command:	<u>01 02 00 00 00 08</u>	<u>01 0F 01 0B 00 02 01 03</u>
	[Leading 6 bytes]	[Response]
Response:	<u>01 02 00 00 00 06</u>	<u>01 0F 01 0B 00 02</u>

➤ A description of the command and response is as follows:

Command:	[Leading 6 bytes]	
Bytes 00-03	01 02 00 00	(Message Number)
Bytes 04-05	00 08	(Number of bytes remaining in this frame)
	[Request]	
Byte 00	01	(Net ID)
Byte 01	0F	(Function Code)
Byte 02-03	010B	(Starting DO Address)
Byte 04-05	0002	(Number of Output Channels)
Byte 06	01	(Byte Count)
Byte 07	03	(Output Value)

Response:	[Leading 6 bytes]	
Bytes 00-03	01 02 00 00	(Message Number)
Bytes 04-05	00 06	(Number of bytes remaining in this frame)
	[Response]	
Byte 00	01	(Net ID)
Byte 01	0F	(Function Code)
Byte 02-03	01 0B	(Starting DO Address)
Byte 04-05	00 02	(Number of Input Channels)

6.2.8 16(0x10) Set Multiple Registers (Write AO values)

This function code is used to set multiple holding registers that are used to store the configuration values for the ET-2200 series module.

[Request]

Byte	Description	Size	Value
00	Net ID (Station Number)	1 Byte	1 to 247
01	Function Code	1 Byte	0x10
02-03	Starting AO Address	2 Bytes	Refer to Section 6.3 or 6.4 "Modbus Register Table" to find the address. Byte 02 = high byte ; Byte 03 = low byte
04-05	Number of 16-bit Registers (Channels)	2 Bytes	Word Count. Byte 04 = high byte ; Byte 05 = low byte
06	Byte Count	1 Byte	n = Points x 2 Bytes
07	Register Values	n Bytes	Register Values. n = 2; Byte 03 = high byte Byte 04 = low byte n = m; Byte m+1 = high byte Byte m+2 = low byte

[Response]

Byte	Description	Size	Value
00	Net ID (Station Number)	1 Byte	1 to 247
01	Function Code	1 Byte	0x10
02-03	Starting AO Address	2 Bytes	The value is the same as Bytes 02-03 of the Request
04-05	Number of 16-bit Registers (Channels)	2 Bytes	The value is the same as Bytes 04-05 of the Request

[Error Response]

Byte	Description	Size	Value
00	Net ID (Station Number)	1 Byte	1 to 247
01	Function Code	1 Byte	0x90
02	Exception Code	1 Byte	Refer to the Modbus Standard Specifications for more details.

Example: Function 16 (0x10), WriteAOs

- Sets the preset value for the digital counter

Command:	[Leading 6 bytes] <u>01 02 00 00 00 0B</u>	[Request] <u>01 10 00 32 0 001 02 03 E8 00 00</u>
Response:	[Leading 6 bytes] <u>01 02 00 00 00 06</u>	[Response] <u>01 10 00 32 00 01</u>

- A description of the command and response is as follows:

Command:	[Leading 6 bytes]	
Bytes 00-03	01 02 00 00	(Message Number)
Bytes 04-05	00 0B	(Number of bytes remaining in this frame)
	[Request]	
Byte 00	01	(Net ID)
Byte 01	10	(Function Code)
Byte 02-03	0032	(Starting AO Address)
Byte 04-05	0001	(Number of 16-bit Registers)
Byte 06	02	(Byte Count)
Byte 07-10	03 E8 00 00	(Preset value for the digital counter)

Response:	[Leading 6 bytes]	
Bytes 00-03	01 02 00 00	(Message Number)
Bytes 04-05	00 06	(Number of bytes remaining in this frame)
	[Response]	
Byte 00	01	(Net ID)
Byte 01	10	(Function Code)
Byte 02-03	0032	(Starting AO Address)
Byte 04-05	00 01	(word count)

6.3 Modbus Register Table (For DIO Module)

Data from 16-bit registers is transmitted in high-byte first order. For example: 0x0A0B ==> 0x0A, 0x0B. Data from 32-bit registers is transmitted as two 16-bit registers and is in low-word first order. For example: 0x0A0B0C0D ==> 0x0C, 0x0D, 0x0A, 0x0B.

6.3.1 Common Functions

➤ 0xxxx: DO Address (Base 0)

Starting Address	Points	Description	Bits per Point	Range	Access Type
127 (0x7F)	1	Restores all default web settings	1	1 = Restore	W (Pulse)
128 (0x80)	1	Default ID Settings	1	1 = Restore	W (Pulse)
133 (0x85)	1	Reboots the ET-2200 module	1	1 = Reboot	W (Pulse)
Notes	"W": Write				

➤ 3xxxx: AI Address (Base 0)

Starting Address	Points	Description	Bits per Point	Range	Access Type
151 (0x97)	1	Firmware Version	16	"123" denotes that the version is 1.2.3	R
158 (0x9E)	1	Modbus Communication Status	16	0 = No Error 1 = Timeout	R
160 (0xA0)	1	Pair-Connection Status	16	0 = Normal 1 = Timeout 2 = Disconnected	R
Notes	"R": Read				

➤ **4xxxx: AO Address (Base 0)**

Starting Address	Points	Description	Bits per Point	Range	Access Type
255 (0xFF)	1	CPU Reset Status	16	1 = Reset at Power-on 2 = Reset by the WDT 3 = Reset using the reset command	R/W
257 (0x101)	1	Sets the Host Watchdog Timer (WDT)	16	<5: Disabled 5 to 65535: Enabled (units: seconds) 0: Default If the ET-2200 series module loses communication with the host PC for more than the period defined in the WDT settings, the DO channels will revert to their safe values and the Host WDT Events Counter will be increased by one.	R/W/F
258 (0x102)	1	Host WDT Events	16	Denotes how many Host WDT Events have occurred since the last CPU reset	R/W
259 (0x103)	1	Module Name	16	Module Name	R
263 (0x107)	1	Sets the TCP Timeout Value	16	<5: Disabled 5 to 65535: Enabled (units: seconds) 0: Default	R/W/F
264 (0x108)	1	Sets the System Timeout Value	16	<30: Disabled 30~65535: Enabled (unit: second) 0: Default	R/W/F
Notes	<p>“R”: Read; “W”: Write; “F”: Setting is recorded in flash as default. Warning: Frequent writing to the Flash can cause it to become corrupt.</p>				

6.3.2 Specific Functions

The nDI and nDO parameters for each ET-2200 series module used in the following Modbus Address Tables are as follows:

Model Name	Universal DIO (UDIO)	Number of DO channels (nDO)	Number of DI channels (nDI)
ET-2242/ET-2242U	-	16	-
ET-2251	-	-	16
ET-2254/ET-2254P	16	Depend on your configuration	Depend on your configuration
ET-2255/ET-2255U	-	8	8
ET-2260	-	6	6
ET-2261	-	10	-
ET-2261-16	-	16	-
ET-2268	-	8	-

➤ 0xxxx: DO Address (Base 0)

Starting Address	Points	Description	Bits per Point	Range	Access Type
0 (0x00)	1 to nDO	Digital Output Channels	1	0 = Off 1 = On	R/W
32 (0x20)	1	Clears the status of all high-latched DI Channels	1	1 = Clear	W
33 (0x21)	1	Clears the status of all low-latched DI Channels	1	1 = Clear	W
34 (0x22)	1 to nDI	Clears the high-speed digital counter for all DI Channels	1	1 = Clear	W
60 (0x3C)	1	Saves specific data to Flash (The access type for some registers labeled with an "E")	1	0: cannot write 1: can be write	W
100 (0x64)	1 to nDO	Enables the PWM for all DO Channels	1	0 = Off 1 = On (Default= 0)	R/W
150 (0x96)	1	Enables the high and low latches for all DI Channels	1	0 = Disable 1 = Enable (Default= 0)	R/W/F

Starting Address	Points	Description	Bits per Point	Range	Access Type
151 (0x97)	1 to nDI	Enables the high-speed digital counter for all DI Channels	1	0 = Disable 1 = Enable (Default= 0)	R/W/F
190 (0xBE)	1 to nDI	Enables frequency measurement for all DI Channels	1	0 = Disable 1 = Enable (Default= 0)	R/W/F
235 (0xEB)	1 to nDO	Sets the Power-on value for all DO Channels	1	0 = Off 1 = On (Default= 0)	R/W/F
267 (0x10B)	1 to nDO	Sets the Safe value for all DO Channels	1	0 = Off 1 = On (Default= 0)	R/W/F
299 (0x12B)	1	Force the DI/DO Mode. (for the ET-2254 only) 0 = Dynamic I/O type based on DO requests. 1 = Static I/O type by configuration (web or Modbus).	1	0 = Dynamic 1= Static	R/W
300 ~ 315 (0x12C ~ 0x13B)	1 to UDIO	Sets the Universal DIO channels to DI or DO Port. (for the ET-2254 only) 300 is the CH0 address, 301 is the CH1 address, and so on.	1	0 = DO type 1= DI type	R/W
Notes	<p>“R”: Read “W”: Write “F”: Settings are recorded in flash by default “E”: After writing DO[60] register, the data will be stored in flash. Warning: Frequency writing to the Flash can cause it to become corrupt.</p>				

**Note:**

Because of the characteristics of the relay functions, it is recommended that the PWM on ET-2260/2261/2268 series (i.e., modules with relay functions) is not used for extended periods.

➤ **1xxxx: DI Address (Base 0)**

Starting Address	Points	Description	Bits per Point	Range	Access Type
0 (0x00)	1 to nDI	The status of all Digital Input Channels	1	0 = Off 1 = On	R
32 (0x20)	1 to nDI	The status of all high-latched DI Channels	1	0 = None 1 = Latched	R
64 (0x40)	1 to nDI	The status of all low-latched DI Channels	1	0 = None 1 = Latched	R
Notes	"R": Read				

➤ **3xxxx: AI Address (Base 0)**

Starting Address	Points	Description	Bits per Point	Value	Access Type
16 (0x10)	1 to nDI	The Digital Counter Value	32	0 to 4294967296	R
64 (0x40)	1 to nDI	The frequency Value is * 1,000. (Note: The Client must first divide the value by 1,000.)	32	0 to 4294967296	R

Note: 

The "DI Counter (0x10)" and "DI Frequency (0x40)" record data as a 32-bit value and are transmitted as two 16-bit registers. Consequently, the register's address has an offset of 2, i.e., the address of the second channel will be at the starting address +2, and so on. You can refer to ["FAQ_How do I read DI Counter for the PETL/t\(P\)ET/ET-2200 Series Modules correctly"](#) for more detailed information.

Example: Reads the 6 DI Counter on the ET-2260.

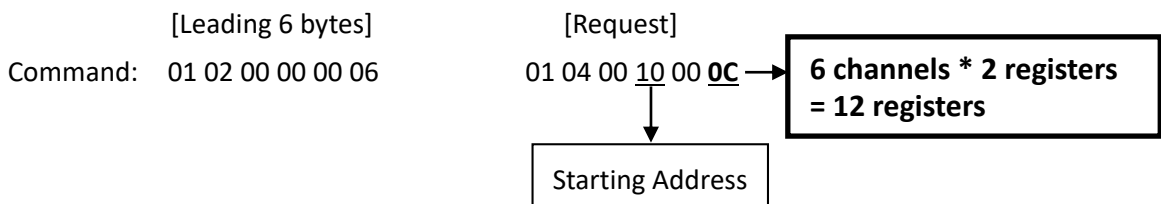

100 (0x64)	1	Number of DI Channels	16	nDI	R
110 (0x6E)	1	Number of DO Channels	16	nDO	R
121 (0x79)	1	Number of high-speed counters	16	nDI	R
Notes	"R": Read				

6.4 Modbus Register Table (For AIO Module)

6.4.1 Modbus Register Table for (P)ET-2215H, (P)ET-2215H-16

➤ Address 3xxxx / 4xxxx (Base 0)

Address	Description	Attribute
30000 ~ 30015 40000 ~ 40015	Temperature of channel 0 to 15	R
30100 40100	Number of the digital input channels	R
30110 40110	Number of the digital output channels	R
30120 40120	Number of the analog input channels	R
30130 40130	Number of the analog output channels	R
30151 40151	Firmware version	R
30180 ~ 30194 40180 ~ 40194	Alias name	R
40212 - 40227	Type code of channel 0 to 15	R/W
40257	Ethernet host watchdog timeout value, 5 to 65535, in second, 0 to disable.	R/W
30258 40258	Ethernet host watchdog timeout count.	R
30259 ~ 30260 40259 ~ 40260	Module name, e.g., (P)ET-2215H displays 0x2215, 0x4800; (P)ET-2215H-16 displays 0x2215, 0x4810	R
40263	TCP disconnection timeout value, 5 to 65535, in second, 0 to disable.	R/W
40264	Module reset timeout value, 30 to 65535, in second, 0 to disable.	R/W
40288 ~ 40303	Channel temperature offset of channel 0 to 15 in 0.01°C	R/W
30320 ~ 30351 40320 ~ 40351	Temperature of channel 0 to 15 in floating point format, two registers for each channel	R

Address	Description	Attribute
40384 ~ 40399	Channel resistance offset of channel 0 to 15 in 0.01 Ω	R/W
30416 ~ 30431 40416 ~ 40431	Resistance of channel 0 to 15 in 0.01 Ω	R
40489	Disable/enable channels. 0: Disable, 1: Enable Bit 0 for channel 0, bit 1 for channel 1, etc.	R/W
40497	Number of moving averaging, 1 to 128, default 1	R/W
40500	Number of moving averaging without written to EEPROM, 1 to 128, default 1	R/W
30512 ~ 30527 40512 ~ 40527	High latched analog input value of channel 0 to 15	R
30544 ~ 30559 40544 ~ 40559	Low latched analog input value of channel 0 to 15	R
00096 ~ 00111	Open wire status of channel 0 to 15, 1 for open wire	R
00127	Write 1 to reload default settings	W
00128	Write 1 to set Modbus TCP ID to 1	W
00133	Write 1 to reboot module	W
00141	Sampling rates, 0: 1.5 Hz, 1: 90 Hz	R/W
00142	Write 1 to reload factory calibration parameters	W
00279	Write 1 to clear all high latched analog input values	W
00280	Write 1 to clear all low latched analog input values	W
00384 ~ 00399	Write 1 to clear high latched analog input value of channel 0 to 15	W
00416 ~ 00431	Write 1 to clear low latched analog input value of channel 0 to 15	W

6.4.2 Modbus Register Table for (P)ET-2217

Coils (0xxxx)

Register		Points	Description	Data Format	Attribute	Factory Value
DEC	HEX					
00162: 00169	00A2: 00A9	8	Clear 1-ch historical AI max. value	1: Clear	W	-
00194: 00201	00C2: 00C9	8	Clear 1-ch historical AI min. value	1: Clear	W	-
00226	00E2	1	Reset the I/O settings to the factory default state	1: Reset	W	-
00233	00E9	1	Reboot the module	1: Reboot	W	-
00595: 00602	0253: 025A	8	Enable/Disable the AI function	0: Disable 1: Enable	R/W/E	1
00628	0274	1	Set the AI sampling rate	0: Normal mode (20 Hz) 1: Fast mode (200 Hz)	R/W/E	0
00631	0277	1	Set the AI data format	0: Hexadecimal format 1: Engineering unit	R/W/E	0
00632	0278	1	Reset the AI calibration to the factory settings	1: Reset	W	-
00634	027A	1	Clear all historical AI max. values	1: Clear	W	-
00635	027B	1	Clear all historical AI min. values	1: Clear	W	-
00636: 00643	027C: 0283	8	Enable/Disable the AI high alarm function	0: Disable 1: Enable	R/W/E	0
00668: 00675	029C: 02A3	8	Enable/Disable the AI low alarm function	0: Disable 1: Enable	R/W/E	0
00700: 00707	02BC: 02C3	8	Set the AI high alarm mode	0: Momentary mode 1: Latching mode	R/W/E	0
00732: 00739	02DC: 02E3	8	Set the AI low alarm mode	0: Momentary mode 1: Latching mode	R/W/E	0
00764: 00771	02FC: 0303	8	Clear the AI high alarm status	1: Clear	W	-

Register		Points	Description	Data Format	Attribute	Factory Value
DEC	HEX					
00796: 00803	031C: 0323	8	Clear the AI low alarm status	1: Clear	W	-
00830	033E	1	Enable/Disable the AI calibration	0: Disable 1: Enable	R/W	-
00831	033F	1	Zero calibration for channel 0	1: Set	W	-
00832	0340	1	Span/Gain calibration for the channel 0 ~ 7	1: Set	W	-
00833	0341	1	AI Input Mode (Differential or Single-ended)	0: Differential 1: Single-ended	R/W/E	-

Discrete Inputs (1xxxx)

Register		Points	Description	Data Format	Attribute
DEC	HEX				
10224: 10231	00E0: 00E7	8	Read AI high alarm status. When the AI value is higher than the high alarm value, the status becomes 1.	0: Normal 1: Alarmed	R
10256: 10263	0100: 0107	8	Read AI low alarm status. When the AI value is lower than the low alarm value, the status becomes 1.	0: Normal 1: Alarmed	R

Input Register (3xxxx)

Register		Points	No. Per Point	Description	Data Format	Attribute
DEC	HEX					
30000: 30007	0000: 0007	8	1	AI value	-32768 to 32767 (0x0000 to 0xFFFF)	R
30236: 30243	00EC: 00F3	8	1	AI historical max. value	-32768 to 32767 (0x0000 to 0xFFFF)	R
30268: 30275	010C: 0113	8	1	AI historical min. value	-32768 to 32767 (0x0000 to 0xFFFF)	R
30320	0140	1	1	Number of the AI channel	8	R
30351	015F	1	1	Firmware version	0x123 means version 1.2.3	R
30360	0168	1	1	Communication state of the pair-connection	0: Normal < 0: Failed	R

Holding Register (4xxxx)

Register		Points	No. Per Point	Description	Data Format	Attribute	Factory Value
DEC	HEX						
40271	010F	1	1	Set the module identification (Modbus NetID)	0 to 255	R/W/E	1
40296: 40303	0128: 012F	8	1	Set the AI high alarm value	-32768 to 32767 (0x0000 to 0xFFFF)	R/W/E	32767 (0x7FFF)
40328: 40335	0148: 014F	8	1	Set the AI low alarm value	-32768 to 32767 (0x0000 to 0xFFFF)	R/W/E	-32768 (0x8000)
40427: 40434	01AB: 01B2	8	1	Set the AI range	0x07: 4 ~ 20 mA 0x08: +/-10 V 0x09: +/-5 V 0x0A: +/-1 V 0x0B: +/-500 mV 0x0C: +/-150 mV 0x0D: +/-20 mA 0x1A: 0 ~ 20 mA	R/W/E	0x08
40555	022B	1	1	Read the module reset status	1: Power-on 2: Module Watchdog 3: Software Reset Command	R	-
40556	022C	1	1	Read the boot count of the module. The factory default value is 0 when the settings are set to the factory default values.	1 to 32767	R	-
40559	022F	1	1	Read the module name	0x2217	R	-

6.4.3 Modbus Register Table for ET-2217CI

➤ Address 3xxxx / 4xxxx (Base 0)

Address	Description	Attribute
30000 ~ 30007 40000 ~ 40007	Analog input values of channels 0 to 7	R
30100 40100	Number of the digital input channels	R
30110 40110	Number of the digital output channels	R
30120 40120	Number of the analog input channels	R
30130 40130	Number of the analog output channels	R
30151 40151	The firmware version	R
30180 ~ 30194 40180 ~ 40194	The alias name	R
40212 ~ 40219	The type codes of analog input channels 0 to 7	R/W
40257	Ethernet host watchdog timeout value, 5 to 65535, in seconds, 0 to disable.	R/W
30258 40258	Ethernet host watchdog timeout count.	R
30259 ~ 30260 40259 ~ 40260	The module name.	R
40263	TCP disconnection timeout value, 5 to 65535, in second, 0 to disable.	R/W
40264	Module reset timeout value, 30 to 65535, in second, 0 to disable. Only for Modbus TCP protocol	R/W
30512 ~ 30519 40512 ~ 40519	The high latched value of analog input channel 0 to 7	R
30544 ~ 30551 40544 ~ 40551	The low latched value of analog input channel 0 to 7	R

Address	Description	Attribute
40864	RTC year (2000 ~ 2159)	R/W
40865	RTC month (1 to 12)	R/W
40866	RTC date (1 to 31)	R/W
40867	RTC hour (0 to 23)	R/W
40868	RTC minute (0 to 59)	R/W
40869	RTC second (0 to 59)	R/W
40870 ~ 40871	The index of the last log record	R
40872 ~ 40873	The index of the log record to be read	R/W
40874	The status of the data logging, 0: stopped, 1: running	R
40875	The data logger command, 0: stop, 1: run in continuous mode, 2: run in a period mode	R/W
40876	If the data logger is full, will it continue to write data? 0: no, 1: yes	R/W
40878	The sampling period of the data logger (units: seconds)	R/W
40879	The sampling period of the data logger (units: milliseconds) (0 to 1000, the value should be a multiple of 5.)	R/W
40880	The starting year of recording in period mode (2000 to 2159)	R/W
40881	The starting month of recording in period mode (1 to 12)	R/W
40882	The starting day of recording in period mode (1 to 31)	R/W
40883	The starting hour of recording in period mode (0 to 23)	R/W
40884	The starting minute of recording in period mode (0 to 59)	R/W
40885	The starting second of recording in period mode (0 to 59)	R/W
40886	The ending year of recording in period mode (2000 to 2159)	R/W
40887	The ending month of recording in period mode (1 to 12)	R/W
40888	The ending date of recording in period mode (1 to 31)	R/W
40889	The ending hour of recording in period mode (0 to 23)	R/W
40890	The ending minute of recording in period mode (0 to 59)	R/W
40891	The ending second of recording in period mode (0 to 59)	R/W
40898 ~ 40899	The index of the first log record	R

Address	Description	Attribute
34097 ~ 34206 44097 ~ 44206	Read log data and it should be multiple of 11 registers. For every 11 registers, they are a value of channel 0, ..., the value of channel 7, time stamp low word, time stamp high word, and millisecond time stamp. The timestamp is in Epoch time format.	R
00096 ~ 00103 10096 ~ 10103	Under range status of channel 0 to 7 for 0mA to 20mA and 4mA to 20mA ranges	R
00127	Write 1 to reload the default settings	W
00128	Write 1 to set Modbus TCP ID to 1	W
00133	Write 1 to reboot the module	W
00140	Data format, 0: hex, 1: engineering	R/W
00141	Sampling rates, 0: 10Hz, 1: 200Hz	R/W
00142	Write 1 to reload factory calibration parameters	W

6.4.4 Modbus Register Table for (P)ET-2218H/S1, (P)ET-2218H-16/S1

➤ Address 3xxxx / 4xxxx (Base 0)

Address	Description	Attribute
30001 ~ 30015 40001 ~ 40015	Temperature of channel 0 to 15	R
30100 40100	Number of the digital input channels	R
30110 40110	Number of the digital output channels	R
30120 40120	Number of the analog input channels	R
30128 40128	CJC temperature in 0.1°C	
30130 40130	Number of the analog output channels	R
30151 40151	Firmware version	R
30180 ~ 30194 40180 ~ 40194	Alias name	R
40212 - 40227	Type code of channel 0 to 15	R/W
40257	Ethernet host watchdog timeout value, 5 to 65535, in second, 0 to disable.	R/W
30258 40258	Ethernet host watchdog timeout count.	R
30259 ~ 30260 40259 ~ 40260	Module name, e.g., (P)ET- 2218H /S1 displays 0x2218, 0x4800; (P)ET- 2218H-16 /S1 displays 0x2218, 0x4810	R
40263	TCP disconnection timeout value, 5 to 65535, in second, 0 to disable.	R/W
40264	Module reset timeout value, 30 to 65535, in second, 0 to disable.	R/W
40288 ~ 40303	Channel temperature offset of channel 0 to 15 in 0.01°C for type M and 0.1°C for other types	R/W
30320 ~ 30351 40320 ~ 40351	Temperature of channel 0 to 15 in floating point format, two registers for each channel	R

Address	Description	Attribute
40384 ~ 40399	Channel CJC offset of channel 0 to 15 in 0.1°C, -128 to 128.	R/W
40489	Disable/enable channels, bit 0 for channel 0, bit 1 for channel 1, etc. 0 to disable and 1 to enable	R/W
40490	Module CJC offset in 0.1°C, -128 to 128	R/W
40497	Number of moving averaging, 1 to 128, default 1	R/W
40500	Number of moving averaging without written to EEPROM, 1 to 128, default 1	R/W
30512 ~ 30527 40512 ~ 40527	High latched analog input value of channel 0 to 15	R
30544 ~ 30559 40544 ~ 40559	Low latched analog input value of channel 0 to 15	R
00096 ~ 00111	Open wire status of channel 0 to 15, 1 for open wire	R
00127	Write 1 to reload default settings	W
00128	Write 1 to set Modbus TCP ID to 1	W
00133	Write 1 to reboot module	W
00141	Sampling rates, 0: 1.5 Hz, 1: 100 Hz	R/W
00142	Write 1 to reload factory calibration parameters	W
00267	1: enable, 0: disable CJC	R/W
00279	Write 1 to clear all high latched analog input values	W
00280	Write 1 to clear all low latched analog input values	W
00384 ~ 00399	Write 1 to clear high latched analog input value of channel 0 to 15	W
00416 ~ 00431	Write 1 to clear low latched analog input value of channel 0 to 15	W

6.4.5 Modbus Register Table for (P)ET-2224CIS/(P)ET-2228CIS

Coils (0xxxx)

Register		Points	Description	Data Format	Attribute	Factory Value
DEC	HEX					
00226	00E2	1	Reset the all settings to the factory default state	1: Reset	W	-
00233	00E9	1	Reboot the module	1: Reboot	W	-
00340: 00347	0154: 015B	4/8	Set OVP Alarm Enable (0/1=Disable/Enable) /Read OVP Alarm Enable Status	0: Disable 1: Enable	R/W/F	0
00360: 00367	0168: 016F	4/8	Clear OVP Alarm Status (wr:1) /Read OVP Alarm Status	(wr:1) 0/1=Normal/Alarm	R/W/F	0
00631	0277	1	Set the AO data format	0: Hexadecimal format 1: Engineering unit	R/W/F	0
00632	0278	1	Reset the AO calibration to the factory settings	1: Reset	W	-
00769: 00776	0301: 0308	4/8	Enable retained analog output for channel 0 to 7	0: Disable 1: Enable	R/W/F	0

F : Setting are recorded in flash by default

Discrete Inputs (1xxxx)

Register		Points	Description	Data Format	Attribute
DEC	HEX				
10290: 10297	0122: 0129	4/8	Read Current mode wire break status.	0: Normal 1: Wire Break	R

Input Register (3xxxx)

Register		Points	No. Per Point	Description	Data Format	Attribute
DEC	HEX					
30000 : 30007	0000: 0007	4/8	1	ADC OVP Read Back Value	Engineering Value, 0 ~ 20000	R
30016: 30023	0010: 0018	4/8	1	Last AO Value	0 to 65535 (0x0000 to 0xFFFF)	R
30064: 30071	0010: 0018	4/8	1	AO Retained Value	0 to 65535 (0x0000 to 0xFFFF)	R
30330	014A	1	1	Number of the AO channel	1	R
30351	015F	1	1	Firmware version	0x0123 means version V01.2.3	R
30360	0168	1	1	Communication state of the pair-connection	1: Connect 0: Disconnect	R

Holding Register (4xxxx)

Register		Points	No. Per Point	Description	Attribute	Factory Value
DEC	HEX			Data Format		
40000: 40007	0000: 0007	4/8	1	AO value 0 to 65535 (0x0000 to 0xFFFF)	R/W	-
40271	010F	1	1	Set the module identification (Modbus NetID) 1 ~ 247	R/W/F	1
40360: 40367	0168: 016F	4/8	1	Set the power-on value for the AO channel 0 to 65535 (0x0000 to 0xFFFF)	R/W/E	0
40392: 40399	0188: 018F	4/8	1	Set the safe value for the AO channel 0 to 65535 (0x0000 to 0xFFFF)	R/W/F	0
40459: 40466	01CB: 01D2	4/8	1	Set the AO range 0x30: 0 ~ 20 mA 0x31: 4 ~ 20 mA 0x32: 0 ~ 10 V 0x34: 0 ~ 5 V	R/W/F	0x32
40523: 40530	020B: 0212	4/8	1	Set the AO slew rate range 0x00: Immediate 0x01: 0.0625 V/sec or 0.125 mA/sec 0x02: 0.125 V/sec or 0.25 mA/sec 0x03: 0.25 V/sec or 0.5 mA/sec 0x04: 0.5 V/sec or 1.0 mA/sec 0x05: 1.0 V/sec or 2.0 mA/sec 0x06: 2.0 V/sec or 4.0 mA/sec 0x07: 4.0 V/sec or 8.0 mA/sec 0x08: 8.0 V/sec or 16 mA/sec 0x09: 16 V/sec or 32 mA/sec 0x0A: 32 V/sec or 64 mA/sec 0x0B: 64 V/sec or 128 mA/sec 0x0C: 128 V/sec or 256 mA/sec 0x0D: 256 V/sec or 512 mA/sec 0x0E: 512 V/sec or 1024 mA/sec	R/W/F	0x00
40555	022B	1	1	Read the module reset status 1: Power-on 2: Module Watchdog 3: Software Reset Command	R	-

Register		Points	No. Per Point	Description	Attribute	Factory Value
DEC	HEX			Data Format		
40556	022C	1	1	Read the boot count of the module. The factory default value is 0, when Reset to factory default.	R	-
				1 to 32767		
40557	022D	1	1	Set the Host WDT timeout (unit: second)	R/W/F	0
				0 ~ 4: Disable the Host WDT 5 ~ 65535: Enable the Host WDT		
40558	022E	1	1	Read the WDT event count. The initial value is 0 when the module is reset, and is increased when the WDT even happens.	R	-
				0 to 32767		
40559	022F	1	1	Read the module ID	R	-
				0x2324/0x2328		
40580: 40587	0244: 024B	4/8	1	Set Over Value Protect Value	R/W/F	-
				Engineering Value, 0 ~ 20000		

6.4.6 Modbus Register Table for (P)ET-2224CI/(P)ET-2228CI

Coils (0xxxx)

Register		Points	Description	Data Format	Attribute	Factory Value
DEC	HEX					
00226	00E2	1	Reset the all settings to the factory default state	1: Reset	W	-
00233	00E9	1	Reboot the module	1: Reboot	W	-
00631	0277	1	Set the AO data format	0: Hexadecimal format 1: Engineering unit	R/W/F	0
00632	0278	1	Reset the AO calibration to the factory settings	1: Reset	W	-
00769: 00776	0301: 0308	4/8	Enable retained analog output for channel 0 to 7	0: Disable 1: Enable	R/W/F	0

F : Setting are recorded in flash by default

Discrete Inputs (1xxxx)

Register		Points	Description	Data Format	Attribute
DEC	HEX				
10290: 10297	0122: 0129	4/8	Read Current mode wire break status.	0: Normal 1: Wire Break	R

Input Register (3xxxx)

Register		Points	No. Per Point	Description	Data Format	Attribute
DEC	HEX					
30016: 30023	0010: 0018	4/8	1	Last AO Value	0 to 65535 (0x0000 to 0xFFFF)	R
30064: 30071	0010: 0018	4/8	1	AO Retained Value	0 to 65535 (0x0000 to 0xFFFF)	R
30330	014A	1	1	Number of the AO channel	1	R
30351	015F	1	1	Firmware version	0x0123 means version V01.2.3	R
30360	0168	1	1	Communication state of the pair-connection	1: Connect 0: Disconnect	R

Holding Register (4xxxx)

Register		Points	No. Per Point	Description	Attribute	Factory Value
DEC	HEX			Data Format		
40000: 40007	0000: 0007	4/8	1	AO value 0 to 65535 (0x0000 to 0xFFFF)	R/W	-
40271	010F	1	1	Set the module identification (Modbus NetID) 1 ~ 247	R/W/F	1
40360: 40367	0168: 016F	4/8	1	Set the power-on value for the AO channel 0 to 65535 (0x0000 to 0xFFFF)	R/W/E	0
40392: 40399	0188: 018F	4/8	1	Set the safe value for the AO channel 0 to 65535 (0x0000 to 0xFFFF)	R/W/F	0
40459: 40466	01CB: 01D2	4/8	1	Set the AO range 0x30: 0 ~ 20 mA 0x31: 4 ~ 20 mA 0x32: 0 ~ 10 V 0x34: 0 ~ 5 V	R/W/F	0x32
40523: 40530	020B: 0212	4/8	1	Set the AO slew rate range 0x00: Immediate 0x01: 0.0625 V/sec or 0.125 mA/sec 0x02: 0.125 V/sec or 0.25 mA/sec 0x03: 0.25 V/sec or 0.5 mA/sec 0x04: 0.5 V/sec or 1.0 mA/sec 0x05: 1.0 V/sec or 2.0 mA/sec 0x06: 2.0 V/sec or 4.0 mA/sec 0x07: 4.0 V/sec or 8.0 mA/sec 0x08: 8.0 V/sec or 16 mA/sec 0x09: 16 V/sec or 32 mA/sec 0x0A: 32 V/sec or 64 mA/sec 0x0B: 64 V/sec or 128 mA/sec 0x0C: 128 V/sec or 256 mA/sec 0x0D: 256 V/sec or 512 mA/sec 0x0E: 512 V/sec or 1024 mA/sec	R/W/F	0x00
40555	022B	1	1	Read the module reset status 1: Power-on 2: Module Watchdog 3: Software Reset Command	R	-

Register		Points	No. Per Point	Description	Attribute	Factory Value
DEC	HEX			Data Format		
40556	022C	1	1	Read the boot count of the module. The factory default value is 0, when Reset to factory default.	R	-
				1 to 32767		
40557	022D	1	1	Set the Host WDT timeout (unit: second)	R/W/F	0
				0 ~ 4: Disable the Host WDT 5 ~ 65535: Enable the Host WDT		
40558	022E	1	1	Read the WDT event count. The initial value is 0 when the module is reset, and is increased when the WDT even happens.	R	-
				0 to 32767		
40559	022F	1	1	Read the module ID	R	-
				0x2324/0x2328		

6.4.7 Modbus Register Table for (P)ET-2224/2228

Coils (0xxxx)

Register		Points	Description	Data Format	Attribute	Factory Value
DEC	HEX					
00226	00E2	1	Reset the I/O settings to the factory default state	1: Reset	W	-
00233	00E9	1	Reboot the module	1: Reboot	W	-
00631	0277	1	Set the AO data format	0: Hexadecimal format 1: Engineering unit	R/W/E	0
00632	0278	1	Reset the AO calibration to the factory settings	1: Reset	W	-

Discrete Inputs (1xxxx)

Register		Points	Description	Data Format	Attribute
DEC	HEX				
10290: 10297	0122: 0129	4/8	Read the Current mode wire break status.	0: Normal 1: Wire Break	R

Input Register (3xxxx)

Register		Points	No. Per Point	Description	Data Format	Attribute
DEC	HEX					
30330	014A	1	1	Number of the AO channel	8	R
30351	015F	1	1	Firmware version	0x123 means version 1.2.3	R
30360	0168	1	1	Communication state of the pair-connection	0: Normal <0: Failed	R

Holding Register (4xxxx)

Register		Points	No. Per Point	Description	Data Format	Attribute	Factory Value
DEC	HEX						
40000: 40007	0000: 0007	4/8	1	AO value	-32768 to 32767 (0x0000 to 0xFFFF)	R/W	-
40271	010F	1	1	Set the module identification (Modbus NetID)	0 to 255	R/W/E	1
40360: 40367	0168: 016F	4/8	1	Set the power-on value for the AO channel	-32768 to 32767 (0x0000 to 0xFFFF)	R/W/E	0
40392: 40399	0188: 018F	4/8	1	Set the safe value for the AO channel	-32768 to 32767 (0x0000 to 0xFFFF)	R/W/E	0
40459: 40466	01CB: 01D2	4/8	1	Set the AO range	0x30: 0~20 mA 0x31: 4~20 mA 0x32: 0~10 V 0x33: +/-10 V 0x34: 0~5 V 0x35: +/-5 V	R/W/E	0x32

Register		Points	No. Per Point	Description	Data Format	Attribute	Factory Value
DEC	HEX						
40523: 40530	020B: 0212	4/8	1	Set the AO slew rate range	0x00: Immediate 0x01: 0.0625 V/sec or 0.125 mA/sec 0x02: 0.125 V/sec or 0.25 mA/sec 0x03: 0.25 V/sec or 0.5 mA/sec 0x04: 0.5 V/sec or 1.0 mA/sec 0x05: 1.0 V/sec or 2.0 mA/sec 0x06: 2.0 V/sec or 4.0 mA/sec 0x07: 4.0 V/sec or 8.0 mA/sec 0x08: 8.0 V/sec or 16 mA/sec 0x09: 16 V/sec or 32 mA/sec 0x10: 32 V/sec or 64 mA/sec 0x11: 64 V/sec or 128 mA/sec 0x12: 128 V/sec or 256 mA/sec 0x13: 256 V/sec or 512 mA/sec 0x14: 512 V/sec or 1024 mA/sec	R/W/E	0x00

Register		Points	No. Per Point	Description	Data Format	Attribute	Factory Value
DEC	HEX						
40555	022B	1	1	Read the module reset status	1: Power-on 2: Module Watchdog 3: Software Reset Command	R	-
40556	022C	1	1	Read the boot count of the module. The factory default value is 0 when the settings are set to the factory default values.	1 to 32767	R	-
40557	022D	1	1	Set the Host WDT timeout (unit: second)	0: Disable the Host WDT 6 to 65535: Enable the Host WDT	R/W/E	0
40558	022E	1	1	Read the WDT event count. The initial value is 0 when the module is reset and is increased when the WDT event happens.	0 to 32767	R	-
40559	022F	1	1	Read the module name	0x2224/0x2228	R	-

6.5 Analog Input Type and Data Format Table

Type Code	Input Type	Data Format	Max.	Min.
05	-2.5 to +2.5 V	Engineering unit	+25000	-25000
		2's comp HEX	7FFF	8000
06	-20 to +20 mA	Engineering unit	+20000	-20000
		2's comp HEX	7FFF	8000
07	+4 to +20 mA	Engineering unit	+20000	+4000
		2's comp HEX	FFFF	0000
08	-10 to +10 V	Engineering unit	+10000	-10000
		2's comp HEX	7FFF	8000
09	-5 to +5 V	Engineering unit	+5000	-5000
		2's comp HEX	7FFF	8000
0A	-1 to +1 V	Engineering unit	+10000	-10000
		2's comp HEX	7FFF	8000
0D	-20 to +20 mA	Engineering unit	+20000	-20000
		2's comp HEX	7FFF	8000
1A	0 to +20 mA	Engineering unit	+20000	0
		2's comp HEX	FFFF	0000

6.6 RTD Type Code Table

Type Code	RTD Type	Min.	Max.
0x20	Pt 100, $\alpha = 0.00385$, $-100 \sim 100^{\circ}\text{C}$	-10000	10000
0x21	Pt 100, $\alpha = 0.00385$, $0 \sim 100^{\circ}\text{C}$	0	10000
0x22	Pt 100, $\alpha = 0.00385$, $0 \sim 200^{\circ}\text{C}$	0	20000
0x23	Pt 100, $\alpha = 0.00385$, $0 \sim 600^{\circ}\text{C}$	0	60000
0x24	Pt 100, $\alpha = 0.003916$, $-100 \sim 100^{\circ}\text{C}$	-10000	10000
0x25	Pt 100, $\alpha = 0.003916$, $0 \sim 100^{\circ}\text{C}$	0	10000
0x26	Pt 100, $\alpha = 0.003916$, $0 \sim 200^{\circ}\text{C}$	0	20000
0x27	Pt 100, $\alpha = 0.003916$, $0 \sim 600^{\circ}\text{C}$	0	60000
0x28	Ni 120, $-80 \sim 100^{\circ}\text{C}$	-8000	10000
0x29	Ni 120, $0 \sim 100^{\circ}\text{C}$	0	10000
0x2B	Cu 100, $\alpha = 0.00421$, $-20 \sim 150^{\circ}\text{C}$	-2000	15000
0x2C	Cu 100, $\alpha = 0.00427$, $0 \sim 200^{\circ}\text{C}$	0	20000
0x2E	Pt 100, $\alpha = 0.00385$, $-200 \sim 200^{\circ}\text{C}$	-20000	20000
0x2F	Pt 100, $\alpha = 0.003916$, $-200 \sim 200^{\circ}\text{C}$	-20000	20000
0x80	Pt 100, $\alpha = 0.00385$, $-200 \sim 600^{\circ}\text{C}$	-2000	6000
0x81	Pt 100, $\alpha = 0.003916$, $-200 \sim 600^{\circ}\text{C}$	-2000	6000
0x82	Cu 50, $-50 \sim 150^{\circ}\text{C}$	-5000	15000
0x83	Ni 100, $-60 \sim 180^{\circ}\text{C}$	-6000	18000
0x84	Ni 120, $-80 \sim 150^{\circ}\text{C}$	-8000	15000
0x85	Cu 100, $\alpha = 0.00428$, $0 \sim 150^{\circ}\text{C}$	0	15000
0x86	Pt 100, $\alpha = 0.00385$, $-100 \sim 300^{\circ}\text{C}$	-10000	30000
0x87	Pt 100, $\alpha = 0.003916$, $-100 \sim 300^{\circ}\text{C}$	-10000	30000

For ranges of type code 0x23 and 0x27, the under range value is 0 and the over range value is +65535. For other ranges, the under range value is -32768 and the over range value is +32767.

6.7 Thermocouple Type Code Table

Type Code	Thermocouple Type	Min.	Max.
0x0E	Type J Thermocouple -210 ~ 760°C	-2100	7600
0x0F	Type K Thermocouple -270 ~ 1372°C	-2700	13720
0x10	Type T Thermocouple -270 ~ 400°C	-2700	4000
0x11	Type E Thermocouple -270 ~ 1000°C	-2700	10000
0x12	Type R Thermocouple 0 ~ 1768°C	0	17680
0x13	Type S Thermocouple 0 ~ 1768°C	0	17680
0x14	Type B Thermocouple 0 ~ 1820°C	0	18200
0x15	Type N Thermocouple -270 ~ 1300°C	-2700	13000
0x16	Type C Thermocouple 0 ~ 2320°C	0	23200
0x17	Type L Thermocouple -200 ~ 800°C	-2000	8000
0x18	Type M Thermocouple -200 ~ 100°C	-20000	10000
0x19	Type LDIN43710 Thermocouple -200 ~ 900°C	-2000	9000

The under range value is -32768 and the over range value is +32767.

Appendix A: Troubleshooting

A.1 How can I Factory Reset the Module (Password: Admin)?

If the module encounters an anomaly and you cannot access the module's web server for configuration, or if you have forgotten the login password, you can perform a factory reset of the module. **Please note that after completing the following steps, all of your customized settings will be erased**

Step 1

Adjust the Init/Run switch to the "Init" mode and reboot the module to load factory settings, including the default web password.



Step 2

Execute the eSearch Utility to verify that the module has been reset to the factory settings. For example, the default IP address is "192.168.255.1". And then, modify the network settings (e.g., the IP, Mask, and Gateway addresses) and click the "OK" button.

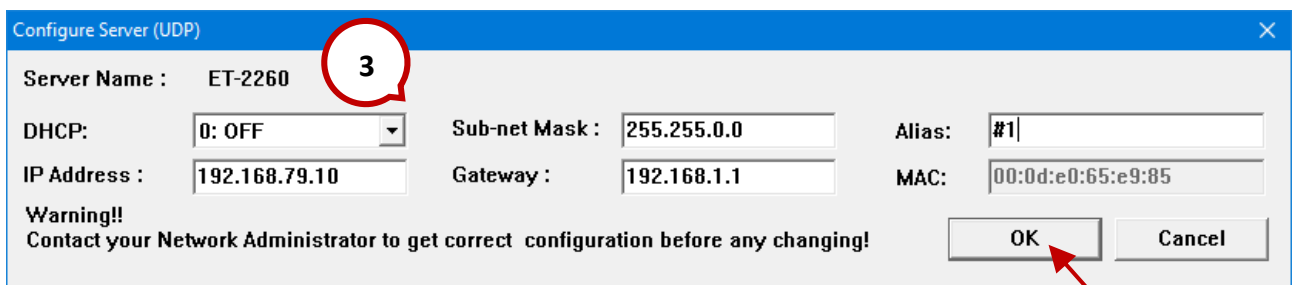
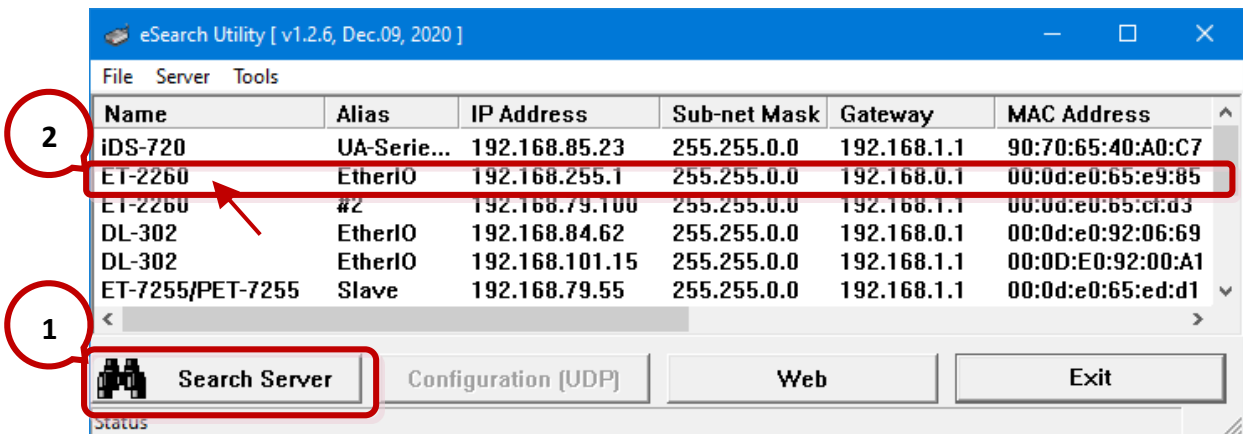

Step 3

Adjust the Init/Run switch back to the "Run" mode and reboot the module.



Step 4

Log in to the ET-2200 web server. Enter the factory password "Admin" and specify the new password, and then click the **Submit** button to save the settings.

A screenshot of the ICP DAS web interface. The page title is "Ethernet I/O Module" with a navigation menu including Home, Network, I/O Settings, Sync, PWM, Pair, Filter, Monitor, Password, and Logout. The current page is "Change Password" with a note that the password length is 12 characters maximum. There are three password input fields: "Current password", "New password", and "Confirm new password". A "Submit" button is located at the bottom right. A red callout box highlights the text "Default Password: Admin". A mouse cursor is pointing at the "Submit" button.

A.2 How to update the firmware via Ethernet?

If the module is not functioning correctly (e.g. there is no response to a search request, or if the system LED is continuously displayed as either OFF or ON), download new firmware from the ICPDAS website. <http://www.icpdas.com/en/download/show.php?num=2626>

To update the Firmware for your ET-2200 module, connect the ET-2200 module and PC in the same sub-network. Please note that there should be only one network card on the PC. Then, download and install the **eSearch Utility**:

http://www.icpdas.com/en/product/guide+Software+Utility_Driver+eSearch__Utility

Step 1: Run the **eSearch utility** and click on the **Search Server** button to find the ET-2200 module.

Step 2: Right-click on the module name and select **Firmware Update**.

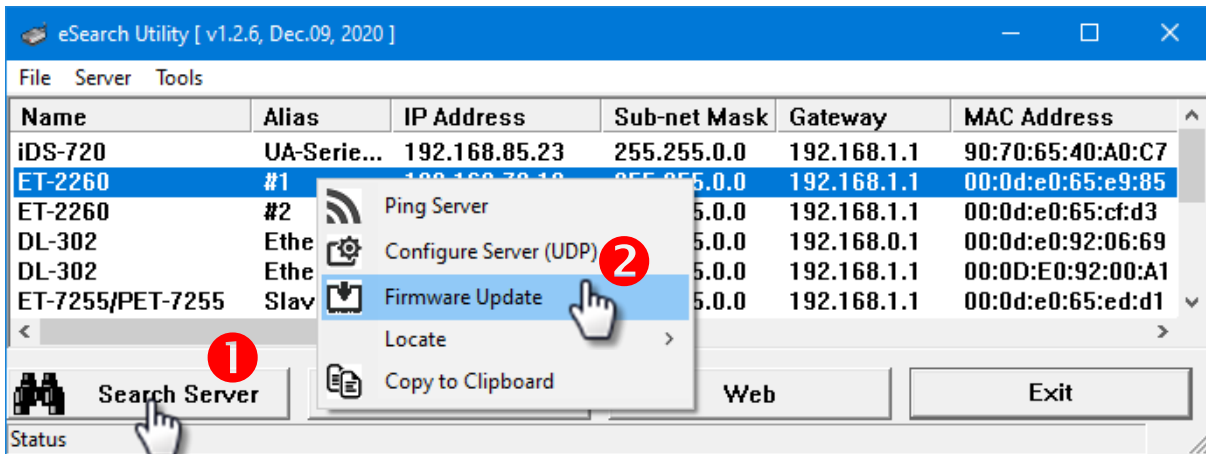

Step 3: Select the firmware file and click on the **Open** button.

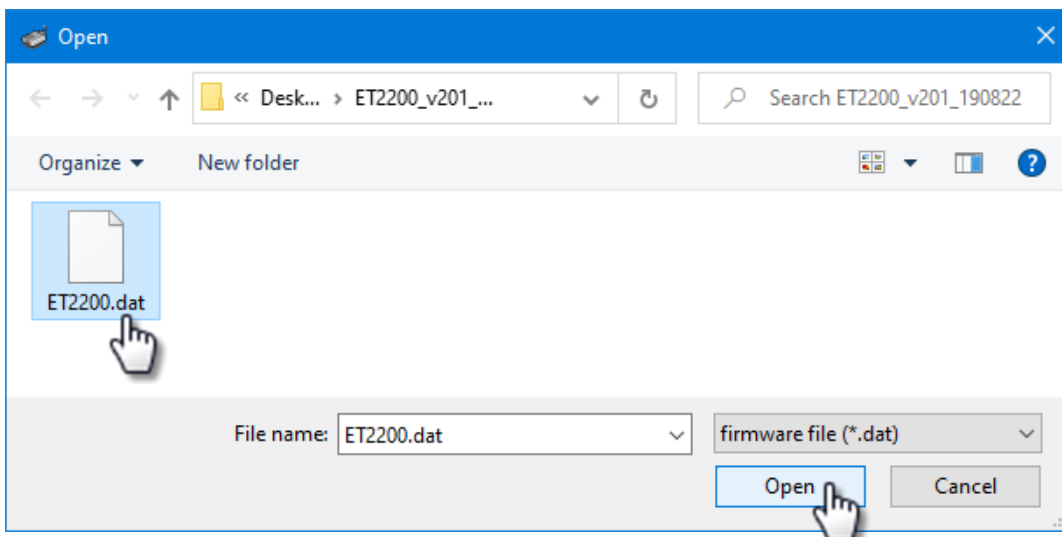

Step 4: Make sure the IP address and MAC address are correct. Click on the OK button.

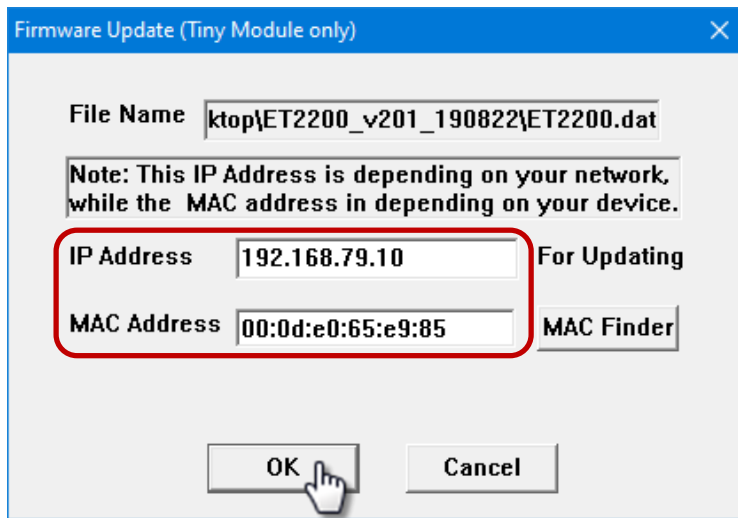

Step 5: The progress 0% will be displayed in a command prompt window. Follow the steps.

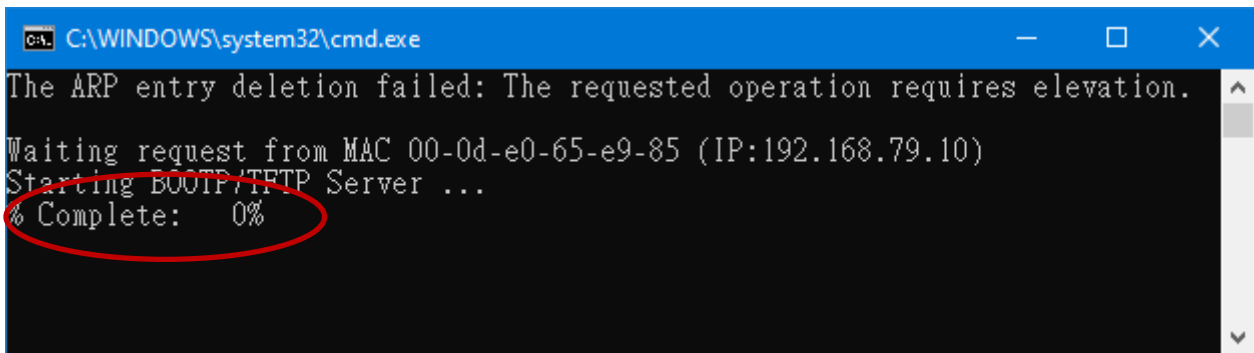

Method 1 - Local Update:

Set the Init/Run switch to the "Init" position and reboot the module to start the update.

Method 2 - Remote Update:

Click the **Web** button and log into the web page of the module, and then click the **Update** button on the **Network** page to start the update.

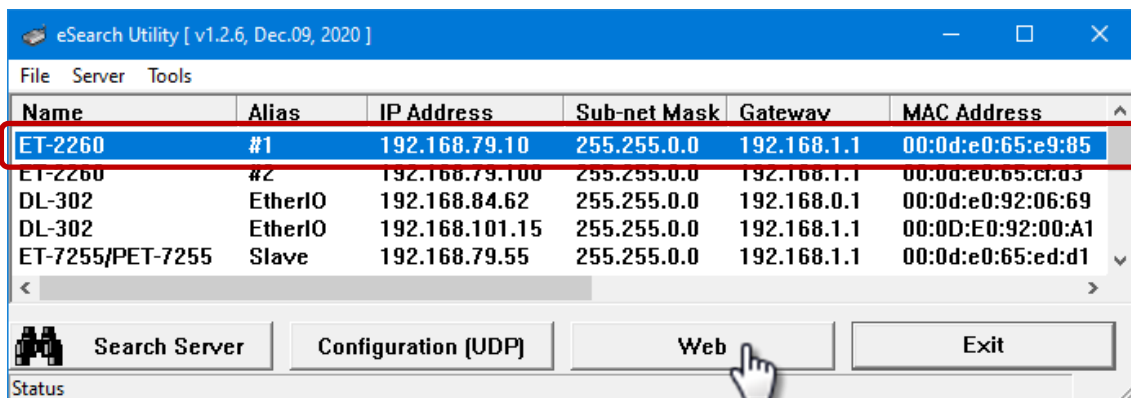

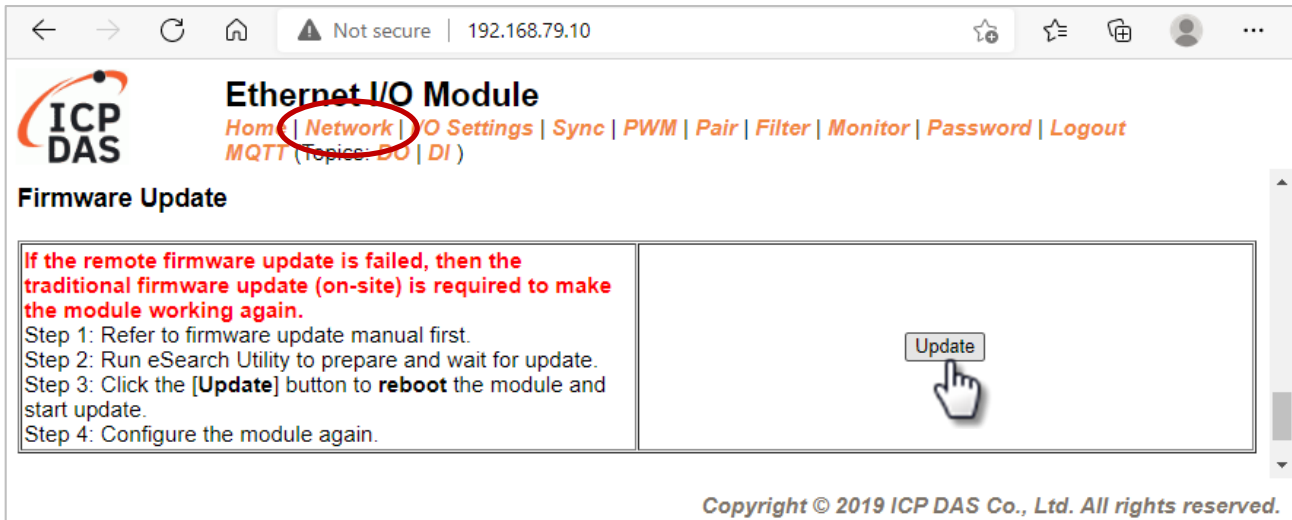

Step 6: After the update is complete, press any key to close the window. For the local update, Set the Init/Run switch to the "Run" position and reboot the module.

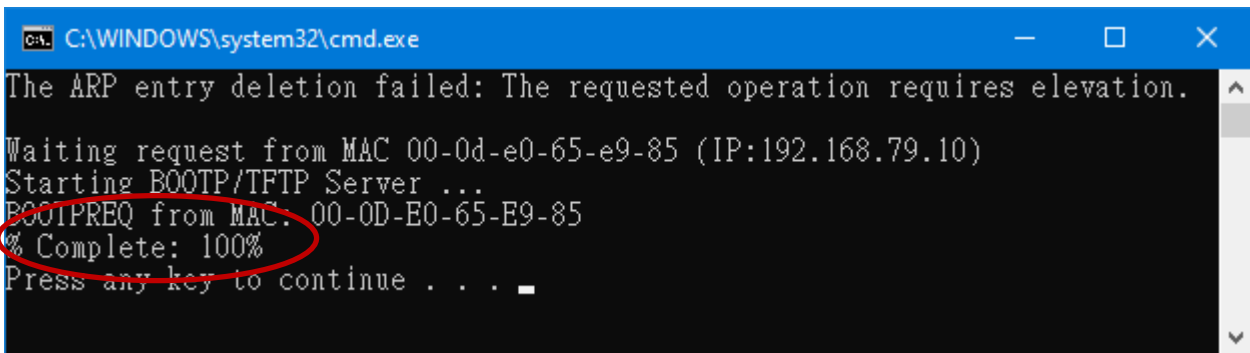

Step 7: Search the module again and log into the web page by using the eSearch Utility. After that, the user can check the **Firmware Version** on the **Home** page.

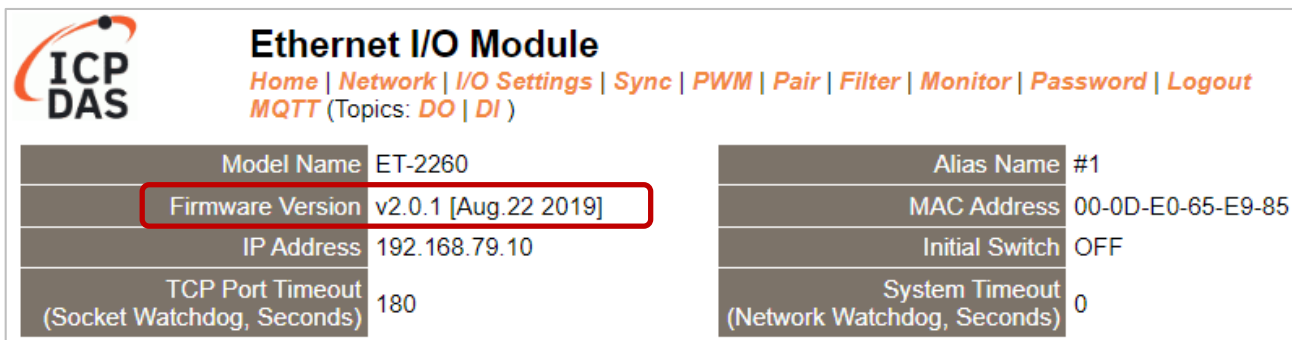

A.3 Why is the Host computer unable to ping or search for the ET-2200 module?

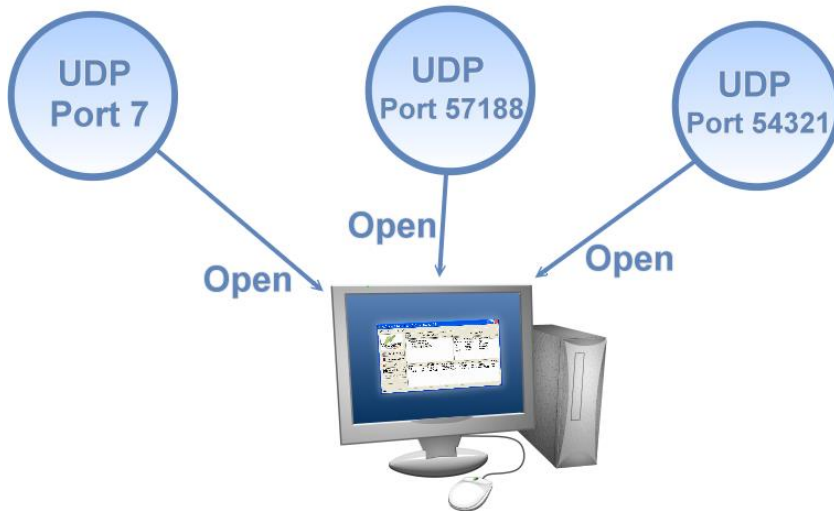

The Host computer can only establish communication with a module through specific ports. Confirm with your network administrator that access to UDP Port 7, Port 57188, and Port 54321 is not being denied by another network device.

The following provides more detailed information related to TCP/UDP ports:

TCP Port:

Port Number	Description
80	HTTP (Hyper Text Transport Protocol)
502	Modbus Data Port

UDP Port:

Port Number	Description
7	Echo (Ping)
57188	UDP Search Request
54321	UDP Search Response

A.4 What is Digital-Input Filter (DI Filter)?

A: An input signal can come from a myriad of sources, such as buttons, switches, sensors, relays, etc. Each of these types of mechanical devices also contributes to a common problem - “**contact bounce**”.

The switch between Digital Input states is usually accompanied by several unwanted pulses, known as “switch bounce”. In certain environments and situations, these input signals may inevitably generate an unstable signal or noise, which can potentially cause incorrect data counting or operation failure. Consequently, these errors must be removed from the input signals, especially if the signals are used in crucial applications.

A low-pass Digital Input filter is a software function that can be used to eliminate high-frequency interference from input signals. The input state will only be changed when the width of any new signal is greater than the value specified as the filtering time, meaning that short, high-frequency interference pulses will be ignored, as illustrated in the diagram below. This is especially useful when attempting to eliminate contact bounce.

